

# DESCRIPTION AND RATING

## FULL-WAVE RECTIFIER GL-6087

FIVE-STAR TUBE

★ ★ ★ ★ ★

The GL-6087 is a full-wave high-vacuum rectifier for use in power supplies of moderate current requirements. The tube incorporates a unipotential cathode which is internally connected to the filament. The heating time of the tube, consequently, is approximately the same as that of other heater-cathode tubes in the equipment. This construction minimizes excessive surge voltages across the filter input capacitors during the warm-up period.

The GL-6087 is especially designed to assure dependable life and reliable service under the exacting conditions encountered in mobile and aircraft applications. Features include a high degree of mechanical strength, a heater-cathode construction designed to withstand many-thousand cycles of intermittent operation, and the ability to perform satisfactorily at altitudes as high as 60,000 feet. Within the limitations of its maximum ratings, the GL-6087 is a replacement for the 5Y3-GT.

### TECHNICAL INFORMATION

#### GENERAL

##### Electrical Data

Cathode - Coated Unipotential

Heater Voltage (A-c or D-c)	5.0	Volts
Heater Current	2.0	Amperes

##### Mechanical Data

Mounting Position - Any \*

Envelope - T-9 Glass

Base - Short Intermediate-Shell Octal 5-pin, B5-62

#### MAXIMUM RATINGS

Electrical †, Design Center Values  
Rectifier Service - Sinusoidal Supply Voltages,  
Frequency Range 25 to 1000 Cycles per Second

Peak Inverse Plate Voltage		
Altitudes up to 60,000 Feet	1400	Volts
A-c Plate Supply Voltage, per Plate, RMS - See Rating Chart I ‡		
Steady-State Peak Plate Current, per Plate	375	Milliamperes
Transient Peak Plate Current, per Plate (maximum duration 0.2 second)	1.7	Amperes
D-c Output Current - See Rating Chart I ‡		

#### Mechanical

Peak Impact Acceleration §	700	G
Bulb Temperature at Hottest Point (Absolute Maximum)	+220	C

#### CHARACTERISTICS AND TYPICAL OPERATION

	Capacitor Input Filter	Choke Input Filter	
Full-Wave Rectifier			
A-c Plate-Supply Voltage, per Plate, RMS	350	500	Volts
Filter Input Capacitor	10	--	Microfarads

CHARACTERISTICS AND TYPICAL OPERATION (CONT'D)

	Capacitor Input Filter	Choke Input Filter	
Filter Input Choke	--	10	Henrys
Total Plate-Supply Resistance, per Plate	130	--	Ohms
D-c Output Current	125	125	Milliamperes
D-c Output Voltage at Filter Input	315	390	Volts
Tube Voltage Drop			
Measured With Applied D-c at 125 Milliamperes per Plate		50	Volts

\* So that the tube socket will not become a limiting factor in high-altitude operation care should be taken to select one with high voltage-breakdown capabilities.

† To simplify the application of the maximum ratings to circuit design, the electrical design center maximum ratings are also presented in chart form as Rating Charts I, II, and III. Rating Chart I presents the maximum ratings for a-c plate-supply voltage and d-c output current. Rating Chart II provides a convenient method for checking conformance with the maximum steady-state peak-plate-current rating. Rating Chart III offers a convenient method for checking conformance with the maximum transient peak-plate-current rating.

With a capacitor-input filter, the conditions of each of Rating Charts I, II, and III must be satisfied in order to obtain performance within all of the electrical maximum ratings. With a choke-input filter, operation within the indicated boundary of Rating Chart I will assure performance within all of the appropriate electrical maximum ratings.

‡ The maximum ratings for a-c plate supply voltage and d-c output current are inter-related and are also dependent on whether a choke or capacitor-input filter is employed. This relationship is shown in Rating Chart I. With a capacitor-input filter, the operating point of d-c output current and a-c supply voltage must fall within the curve FAEDG. With a choke-input filter, the operating point must fall within the curve FABCDG.

§ Forces in any direction as applied by the Navy-type High Impact (flyweight) Shock Machine for Electronic Devices or its equivalent.

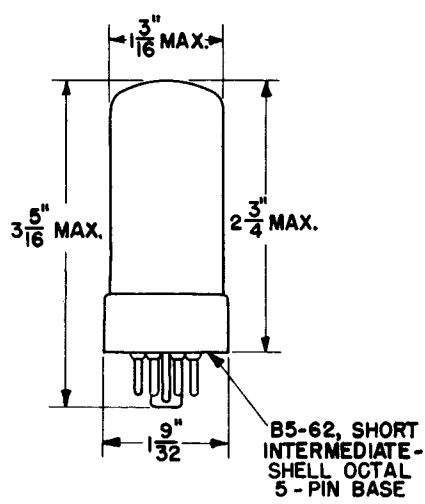

BASING DIAGRAM

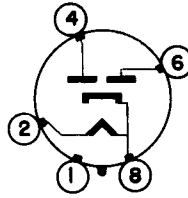

KEY  
5L

- PIN 1: NO CONNECTION
- PIN 2: HEATER
- PIN 4: PLATE NO. 2
- PIN 6: PLATE NO. 1
- PIN 8: HEATER AND CATHODE

K-69087-72A547 September 17, 1952

Outline  
GL-6087

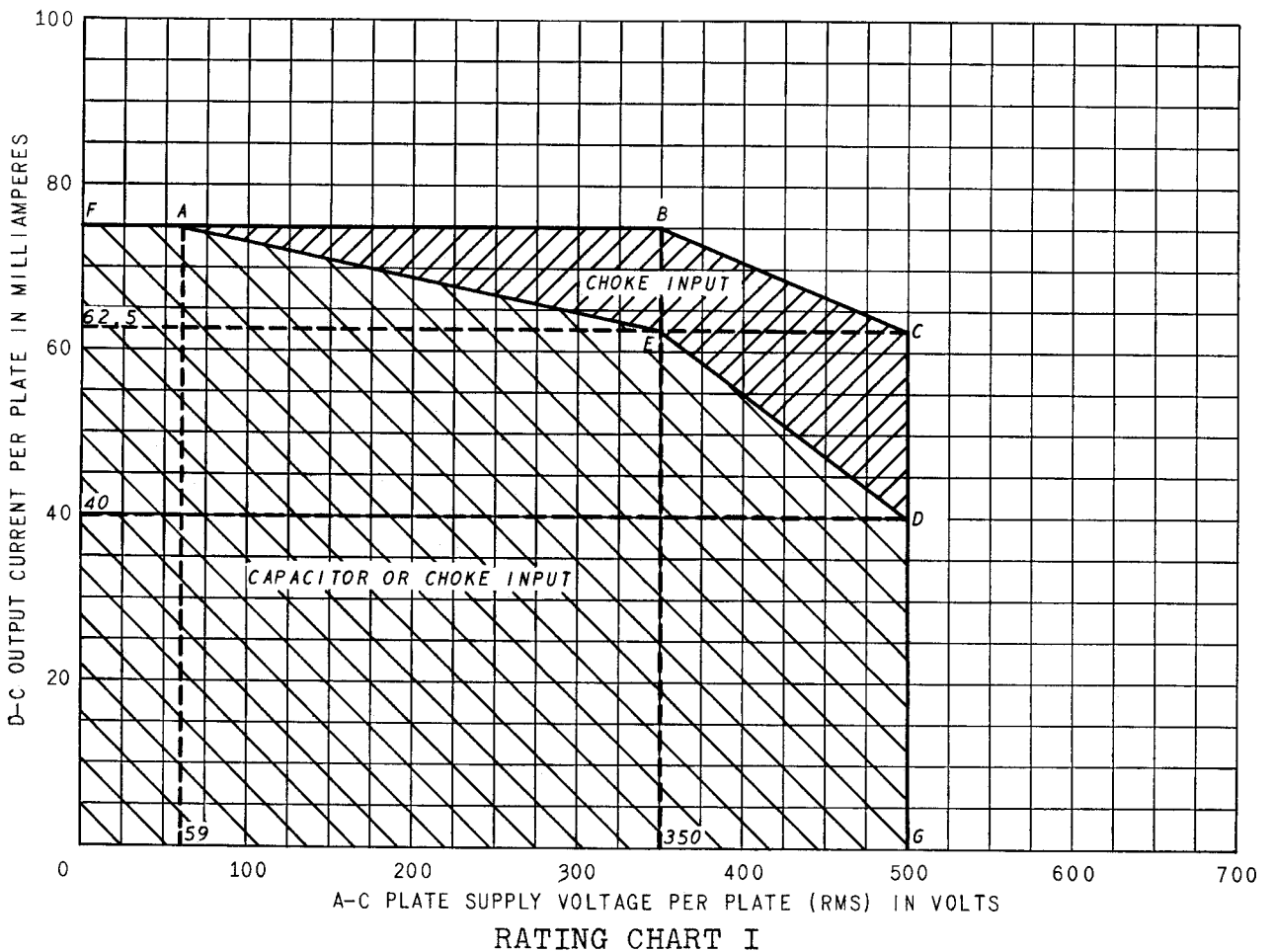

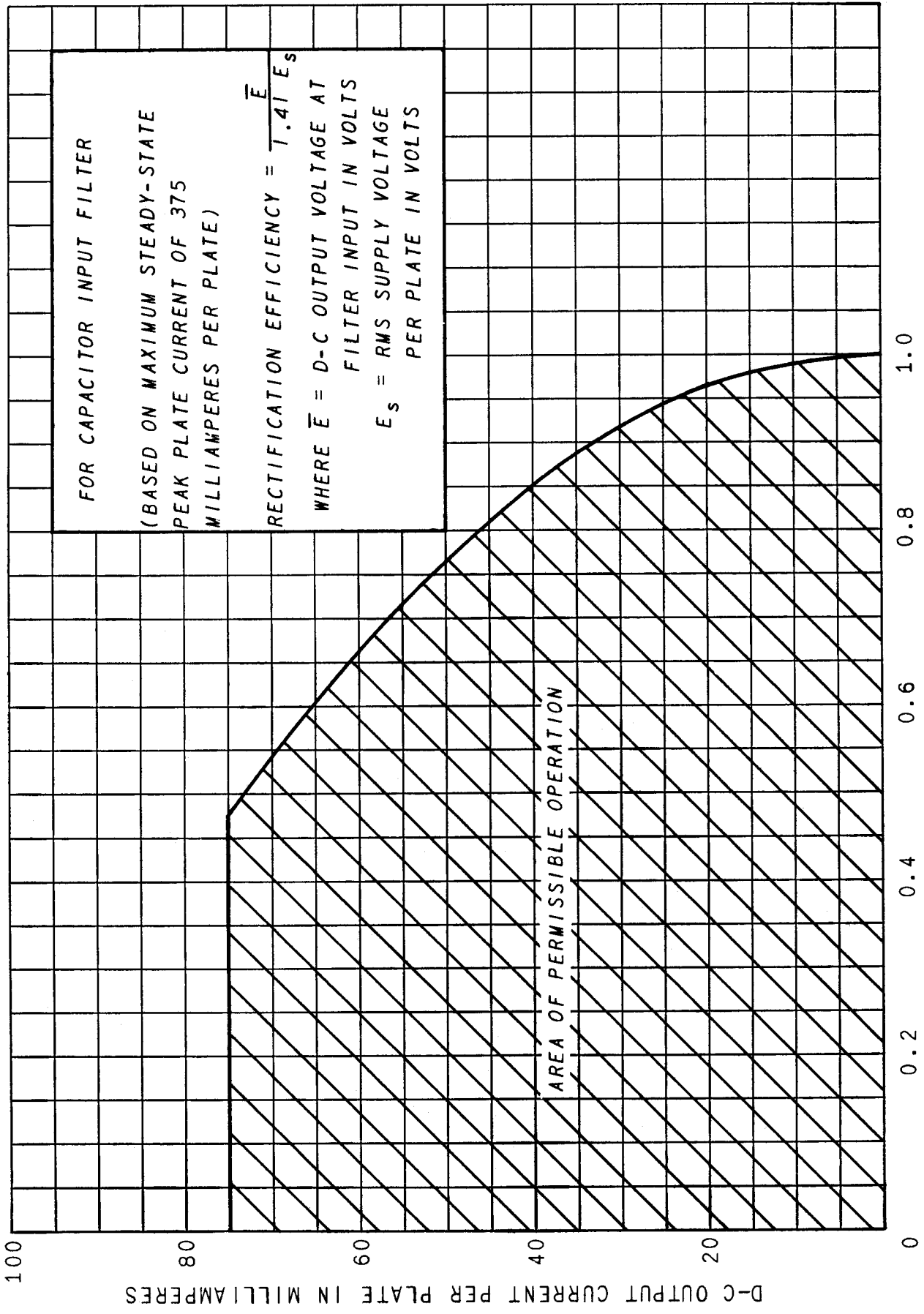

RECTIFICATION EFFICIENCY  
 RATING CHART II

MINIMUM PLATE SUPPLY RESISTANCE PER PLATE ( $R_s$ ) IN OHMS

FOR CAPACITOR INPUT FILTER

(BASED ON MAXIMUM TRANSIENT PEAK PLATE CURRENT OF 1.7 AMPERES PER PLATE)

$$R_s = R_{sec} + N^2 R_{prim} + R_A$$

WHERE  $R_s$  = PLATE SUPPLY RESISTANCE PER PLATE

$R_{sec}$  = D-C RESISTANCE OF TRANSFORMER SECONDARY PER SECTION

$R_{prim}$  = D-C RESISTANCE OF TRANSFORMER PRIMARY

$R_A$  = D-C RESISTANCE OF ADDED SERIES RESISTANCE PER PLATE

$N$  = TRANSFORMER VOLTAGE STEP-UP RATIO PER SECTION

IF SERIES INDUCTANCE IS PRESENT IN THE PLATE SUPPLY, IT IS PERMISSIBLE TO USE A SMALLER-THAN-INDICATED VALUE OF PLATE SUPPLY RESISTANCE PROVIDING THE RATED MAXIMUM VALUE OF TRANSIENT PEAK PLATE CURRENT IS NEVER EXCEEDED.

0

100

200

300

400

500

600

700

A-C PLATE SUPPLY VOLTAGE PER PLATE (RMS) IN VOLTS

RATING CHART III

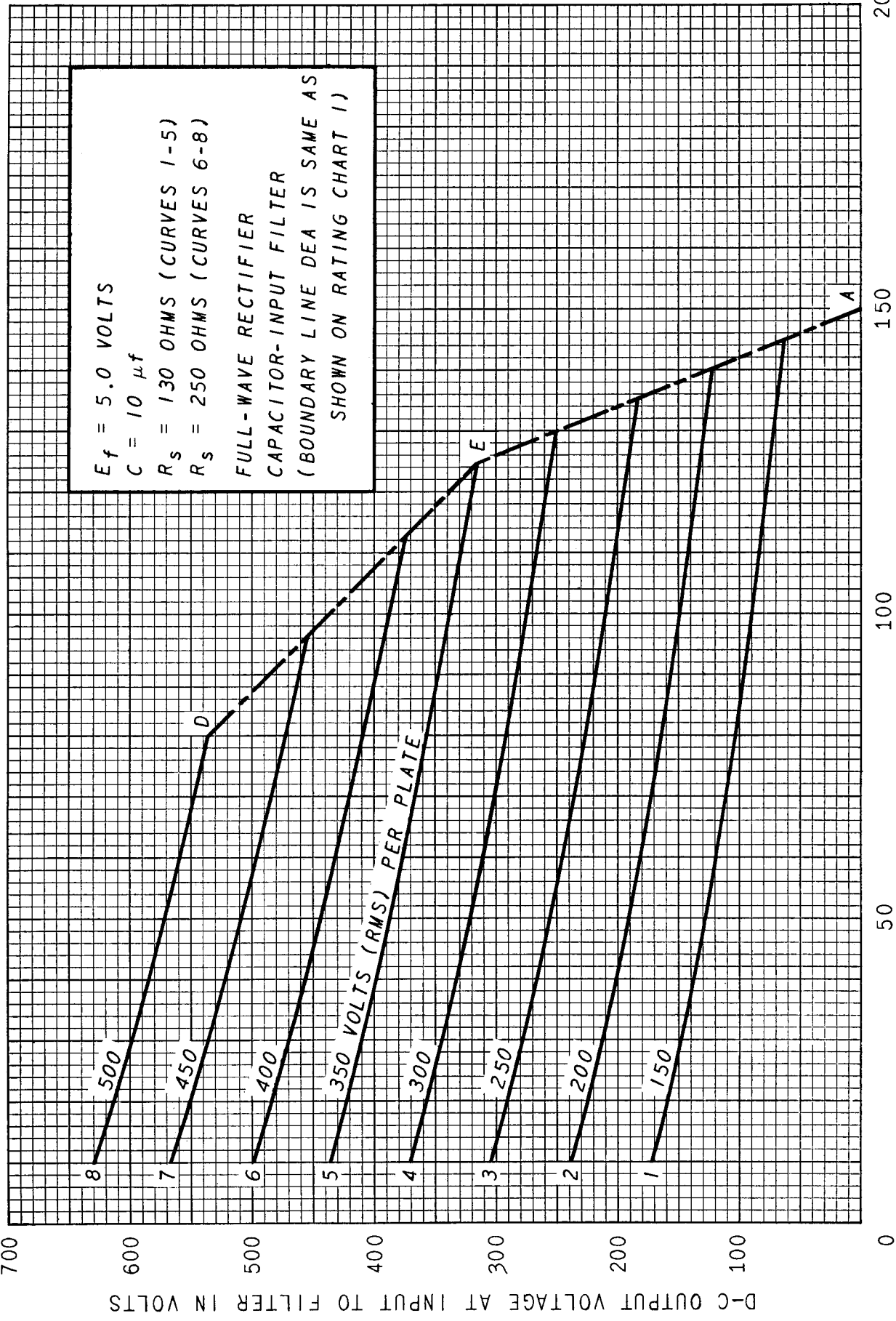

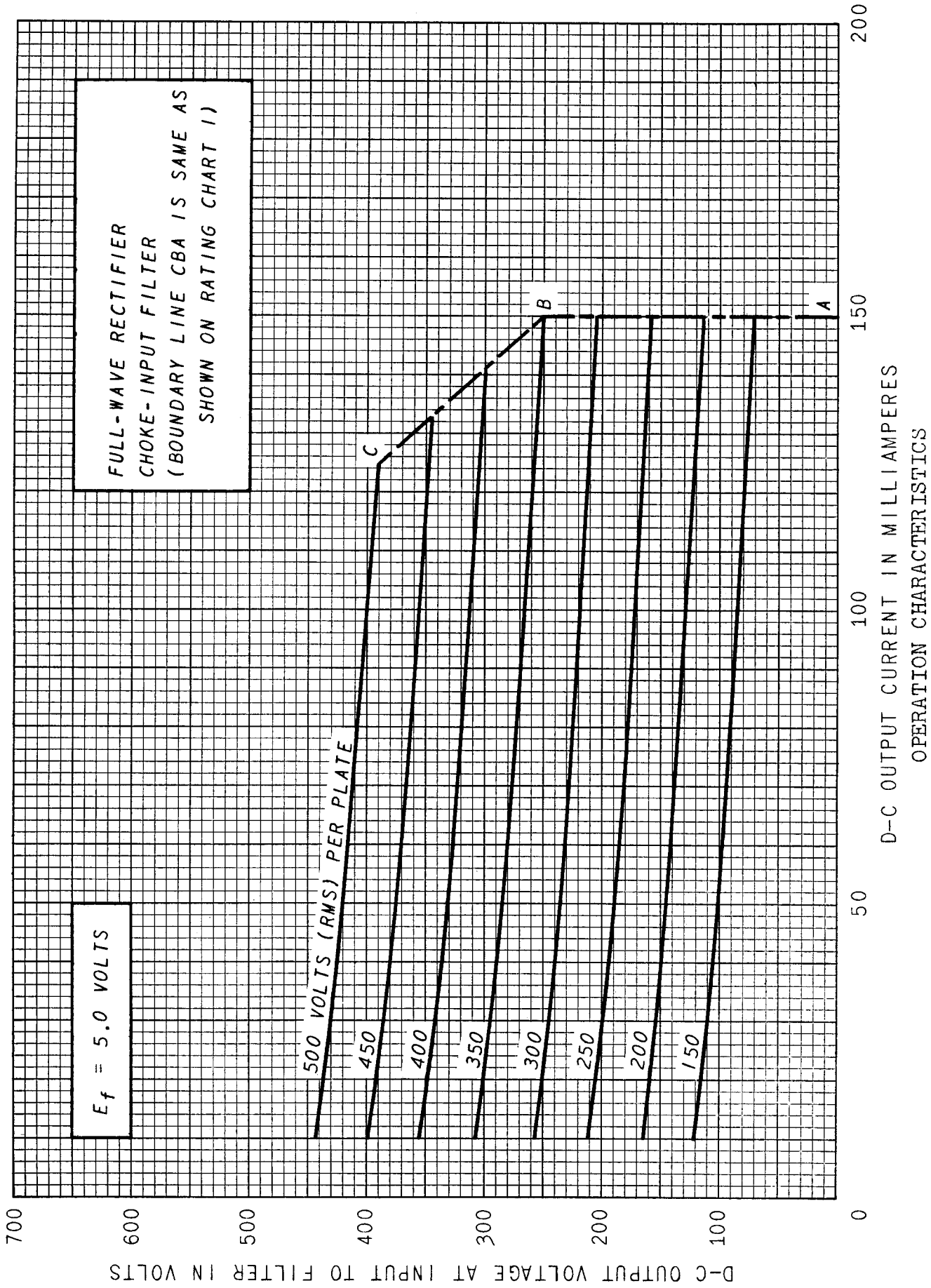

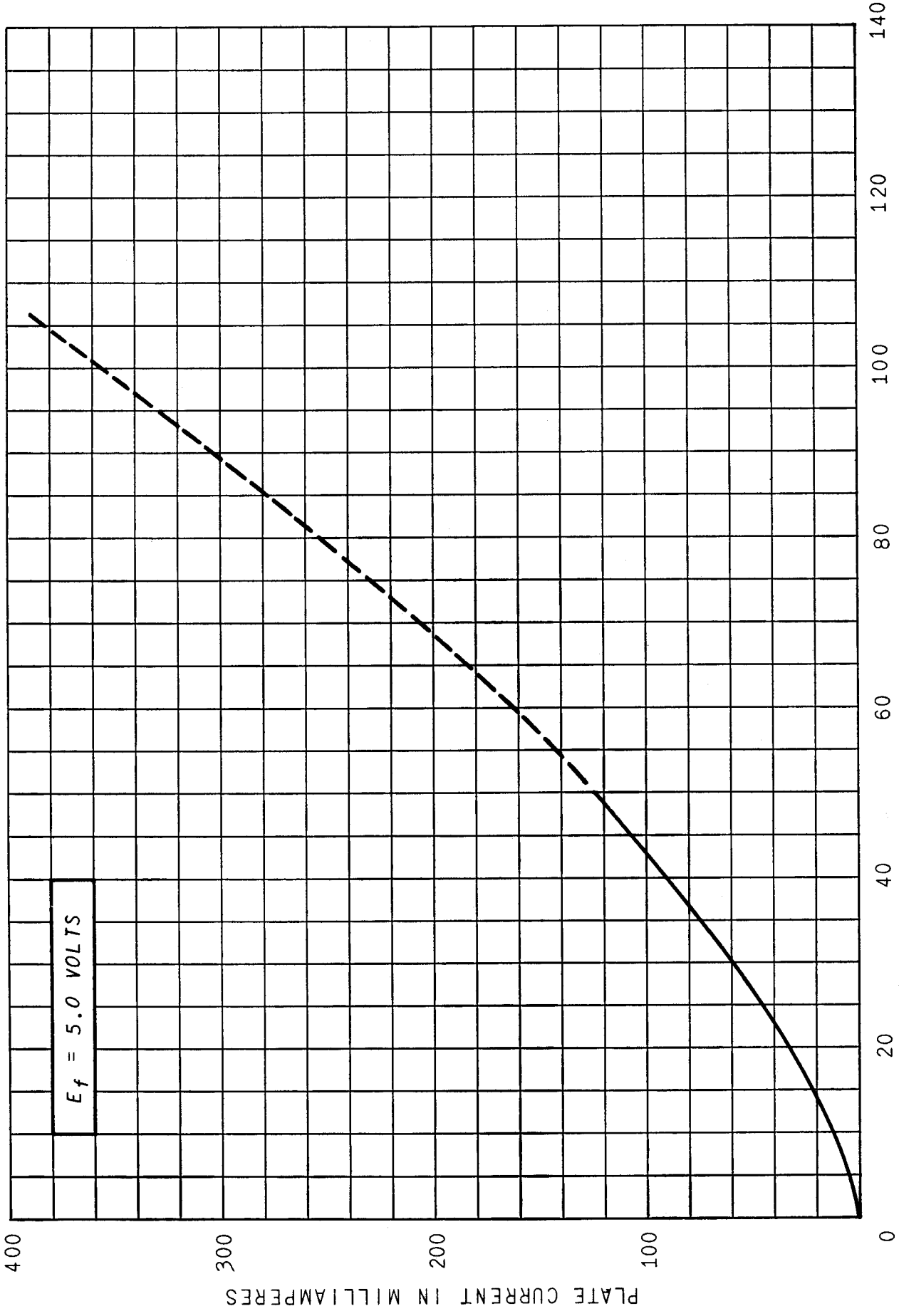

PLATE VOLTAGE IN VOLTS  
AVERAGE PLATE CHARACTERISTICS  
EACH SECTION

$E_f = 5.0$  VOLTS



The maximum ratings of high-vacuum rectifier tubes are based on inherent physical limitations of the tubes. Generally these ratings are expressed by the following quantities:

- Maximum peak inverse plate voltage
- Maximum a-c plate supply voltage (per plate)
- Maximum steady-state peak plate current (per plate)
- Maximum transient peak plate current (per plate)
- Maximum d-c output current
- Maximum heater-cathode voltage (cathode types only)

Although operation within the specified limits of these maximum ratings assures proper tube usage, the system involves some relatively difficult measurements and consequently imposes a considerable burden on the circuit designer.

To simplify the application of these maximum ratings to circuit design, a system of presenting rectifier ratings in the form of three rating charts has been developed. These rating charts, which are designated as Rating Charts I, II, and III, represent an alternate presentation of the maximum ratings and are applicable whenever the tube is used in a conventional rectifier circuit with an applied sinusoidal supply voltage.

Use of the rating charts requires only simple measurements of circuit characteristics with standard industrial meters. With a capacitor-input filter, proper tube usage requires that the operating characteristics satisfy the conditions of each of Rating Charts I, II, and III. With a choke-input filter, proper tube usage requires that the operating characteristics be within the prescribed area of permissible operation on Rating Chart I. In the case of heater-cathode types, the maximum heater-cathode-voltage rating is not covered by the rating charts, and attention must also be directed to this rating which is given as a numerical value on the Description and Rating sheet.

The ratings as presented in chart form are on the basis of the standard RTMA System of Design Center Maximums. In addition, the values of a-c supply voltage as presented refer to the unloaded supply voltages.

#### Rating Chart I

The maximum ratings for a-c plate supply voltage and d-c output current are interrelated and are also dependent on whether a choke- or capacitor-input filter is employed. This relationship is shown in Rating Chart I. As indicated on this chart, more lenient operation for one parameter permits the use of more severe operation for the other parameter.

To determine whether a given set of operating conditions is within the maximum ratings presented in Rating Chart I, the operating point of a-c supply voltage (RMS) per plate and d-c output current per plate for the application should be entered on the chart. If, for choke-input-filter operation, this point falls within the boundary FABCDG, operation within the ratings of a-c supply voltage and d-c output current is assured. For capacitor-input-filter operation, the operating point must fall within the boundary FAEDG.

If the operating point falls outside of the prescribed area of permissible operation, either the d-c output current or the a-c supply voltage must be reduced until operation within the area of permissible operation is obtained. The type of corrective action to be taken necessarily depends on the requirements of the application.

## Rating Chart II

Rating Chart II represents a curve of maximum permissible rectification efficiency for capacitor-input-filter operation as a function of d-c output current. The purpose of this rating chart is to assure operation within the maximum steady-state peak-plate-current rating.

Rectification efficiency ( $\eta$ ) is defined as follows:

$$\eta = \frac{\bar{E}}{\sqrt{2} E_s} \quad (1)$$

where  $\bar{E}$  = d-c output voltage at input to filter in volts  
and  $E_s$  = RMS supply voltage per plate in volts.

To determine whether a given set of operating conditions is within the maximum ratings presented in Rating Chart II, the operating point of d-c output current per plate and rectification efficiency should be entered on the chart. If this point falls within the shaded area of the chart, operation within the maximum steady-state peak plate current is assured.

If the operating point falls outside of the prescribed area of permissible operation, corrective action must be taken. For a given a-c supply voltage and d-c output current, the rectification efficiency can usually be reduced either by increasing the total supply resistance per plate or by decreasing the filter input capacitor.

## Rating Chart III

Rating Chart III presents a curve of minimum series plate supply resistance as a function of a-c supply voltage. The purpose of this chart is to assure operation within the maximum transient peak-plate-current rating. The transient peak plate current is often referred to as the hot-switching current.

Hot switching can occur in capacitor-input-filter circuits if the equipment is switched off and then switched on again before the temperature of the rectifier tube cathode has decreased appreciably. If during the off period the filter capacitor has discharged, a large transient current will flow at the time the supply voltage is reapplied. The largest transient current will occur when the supply voltage is at its peak amplitude at the instant it is reapplied to the circuit.

When the supply voltage is reapplied, the resulting transient current is limited only by the resistance offered by the tube and any resistance which might be in the circuit. Unless sufficient resistance is available to limit the transient current to the rated maximum value, excessive currents can flow which will destroy the rectifier tube. The minimum series plate supply resistance per plate ( $R_s$ ) which is required to maintain the hot-switching current to its rated maximum value can be expressed as

$$R_s = \frac{\sqrt{2} E_s \hat{e}_d(\text{surge})}{\hat{I}_{\text{surge}}} \quad (2)$$

where  $E_s$  = RMS supply voltage per plate in volts,  
 $\hat{I}_{\text{surge}}$  = Maximum transient peak plate current per plate,  
and  $\hat{e}_d(\text{surge})$  = Tube voltage drop in volts corresponding to  $\hat{I}_{\text{surge}}$ .

This equation forms the basis of Rating Chart III.

The minimum series-plate-supply resistance per plate is defined as consisting of the following components.

$$R_s = R_{\text{sec}} + N^2 R_{\text{prim}} + R_a \quad (3)$$

where  $R_{\text{sec}}$  = d-c resistance of transformer secondary per section,  
 $R_{\text{prim}}$  = d-c resistance of transformer primary,  
 $R_a$  = d-c resistance of added series resistance per plate,  
and  $N$  = Transformer voltage step-up ratio per section.

Series inductance in the plate supply is also effective in limiting the transient peak plate current. If appreciable series inductance is present in the plate supply, a smaller-than-indicated value of series-plate-supply resistance may be used providing it is determined experimentally that the combined effect of the available supply resistance and inductance is adequate to limit the transient peak plate current to its rated maximum value.

To determine whether a given set of operating conditions is within the maximum ratings presented in Rating Chart III, the total  $R_s$  is first calculated from measurements of  $R_{pri}$ ,  $R_{sec}$ ,  $R_a$ , and  $N$ . The operating point of  $R_s$  and a-c supply voltage is then entered on Rating Chart III. If the total plate-supply resistance is equal to or greater than the minimum value of  $R_s$ , as indicated by the curve, operation within the maximum transient peak-plate-current rating is assured. If the conditions of Rating Chart III are not satisfied, additional resistance should be added in series with each diode plate so that the indicated minimum value of  $R_s$  is obtained.

It should be noted that the plate-supply resistance serves to limit both the steady-state peak current and the transient peak current. The minimum value of resistance required for these two functions will not necessarily be the same. The larger value of resistance must be used.

### Typical Example

To illustrate the use of the rating charts, consider the following example.

#### Problem:

A full-wave rectifier circuit employing a GL-6087 is operated with an 800-volt center-tapped transformer from a 117-volt supply. The input filter capacitor is 8 microfarads. Determine if the operation of the rectifier tube is within its maximum ratings.

#### Procedure:

The following measurements are made with the circuit operating:

Total D-c Output Current = 110 milliamperes  
D-c Output Voltage at Filter Input,  $\bar{E}$  = 410 volts

The following measurements are made with the tube removed from its socket:

RMS Transformer Primary Voltage,  $E_{pri}$  = 117 volts RMS  
RMS Transformer Secondary Voltage per Plate,  $E_s$  = 400 volts RMS

The following measurements are made with the supply voltage removed:

D-c Resistance of the Transformer Primary,  $R_{pri}$  = 2.4 ohms  
D-c Resistance of the Transformer Secondary per Section,  $R_{sec}$  = 88 ohms

Reference is next made to the published rating charts for the GL-6087.

#### Rating Chart I

A-c Plate Supply Voltage per Plate (RMS) = 400 volts.  
D-c Output Current per Plate =  $\frac{110}{2}$  = 55 milliamperes.

The point having as coordinates 400 volts and 55 milliamperes is entered on Rating Chart I. As this point is within the area indicated for capacitor-input filter, the conditions of Rating Chart I are satisfied.

#### Rating Chart II

Rectification Efficiency,  $\eta$ , is calculated from Equation (1).

(1)

$$\eta = \frac{\bar{E}}{\sqrt{2} E_s}$$

$$\bar{E} = 410 \text{ volts}$$

$$E_s = 400 \text{ volts}$$

$$\eta = \frac{410}{1.414 (400)} = 0.725$$

D-c Output Current per Plate = 55 milliamperes

The point having as coordinates 0.725 and 55 milliamperes is entered on Rating Chart II. As this point is not within the area of permissible operation, the conditions of Rating Chart II are not satisfied. Before corrective action is taken, however, conformance with Rating Chart III will be examined.

#### Rating Chart III

The supply resistance per plate,  $R_s$ , is calculated from Equation (3).

$$\begin{aligned} R_s &= R_{sec} + N^2 R_{prim} + R_a & (3) \\ N &= \frac{400 \text{ volts RMS}}{117 \text{ volts RMS}} = 3.42 \\ N^2 &= 11.7 \\ R_{sec} &= 88 \text{ ohms} \\ R_{prim} &= 2.4 \text{ ohms} \\ R_a &= 0 \text{ ohms} \\ R_s &= 88 + 11.7 (2.4) + 0 \\ R_s &= 116 \text{ ohms} \end{aligned}$$

A-c Plate Supply Voltage per Plate (RMS) = 400 volts

The point having as coordinates 116 ohms and 400 volts is entered on Rating Chart III. As 116 ohms is less than the required minimum value of 165 ohms, the conditions of Rating Chart III are not satisfied. Corrective action is therefore required both for the conditions of Rating Charts II and III.

#### Corrective Action

The corrective action may take any of several forms. Assume, for the present example, that it is decided to add a resistor in series with each plate.

From Rating Chart III, the minimum value of  $R_s$  required for a 400 volt supply is 165 ohms. Therefore, a 56-ohm resistor should be added in series with each plate so that  $R_s$  will be increased from 116 ohms to a value greater than the required 165 ohms.

With a 56-ohm resistor added to each plate, the d-c output voltage and current are again measured and found to be 395 volts and 110 milliamperes. The three Rating Charts are again checked for conformity, but now using  $\eta = 0.698$  and  $R_s = 172$  ohms. The conditions of all three rating charts are now satisfied, and proper tube usage is assured.

The chief advantage of the rating chart method for checking tube operation is that only simple measurements need be made. These include the d-c measurement of output current, output voltage, several resistances, and the a-c measurements of supply voltage and transformer voltage step-up ratio.

The information contained in the rating charts can also be used to advantage in the initial design of the rectifier circuit. When used in conjunction with the published regulation curves, conformity of performance to the maximum ratings can be predicted to a good degree of accuracy.