

# RADIOTRONICS



AN

PUBLICATION

Vol. 27, No. 7

July, 1962

## IN THIS ISSUE

### INTERPRETATION OF VOLTAGE RATINGS FOR TRANSISTORS ..... 122

This article explains basic transistor breakdown mechanisms, and relates them to the various types of voltage ratings used by manufacturers.

### THE TR8 ..... 128

Describing a low cost, compact transistorized stereo amplifier of acceptable performance, rated at 4 watts per channel.

### NEW RELEASES ..... 135

### A USEFUL OUTPUT METER ..... 136

Dual loads of 4, 8 and 16 ohms are provided in this unit, with meter scales of 5, 10 and 50 watts.

# 7

# INTERPRETATION OF VOLTAGE RATINGS FOR TRANSISTORS

By C. R. TURNER

## Introduction

Transistor voltage breakdown is a function of both individual device characteristics and associated circuits. This Note describes basic transistor voltage-breakdown mechanisms and their relationship to external circuits. These mechanisms are then used to explain the various types of voltage ratings used by transistor manufacturers.

Voltage ratings can be readily established for transistors designed for use in specific applications for which both the associated circuit parameters and the required device characteristics are known. For example, specific voltage ratings can be assigned to transistors used in applications such as auto radios, portable radios, and computer circuits, and the large number of transistors produced for these uses can be specially tested to meet these particular ratings.

However, multi-purpose transistors must also have clearly defined voltage ratings which can be easily understood so that these devices can be readily designed into a wide variety of applications. The calculation of these voltage ratings requires a fundamental understanding of transistor voltage-breakdown mechanisms and their circuit dependence.

## Common - Base Avalanche Breakdown

Collector-base breakdown of transistors operating in a common-base connection is caused by avalanche multiplication. When a voltage is applied between collector and base, a depletion layer or space-charge layer is formed at the collector junction and spreads out into both the collector and base regions. Avalanche multiplication takes place in this depletion layer when a high electric field is present. This multiplication effect, which is similar to the "Townsend effect" in gas tubes, is the result of collisions between rapidly accelerating minority carriers that enter the depletion layer and atoms in the crystal lattice. Energy transferred to the atoms as a result of these collisions causes ionization, which releases valence

electrons; these electrons are then also accelerated. Avalanche breakdown differs from Zener breakdown in that no multiplication takes place because no free carriers are present in the Zener condition. All the carriers of the Zener breakdown are formed by stripping of valence electrons in a high-strength field.

The multiplication  $M$  that takes place for a given collector-to-base voltage ( $V_{CB}$ ) is given by the following empirical formula for junction transistors:

$$M = \frac{1}{1 - \left(\frac{V_{CB}}{V_A}\right)^n} \quad (1)$$

where  $V_A$  is the true avalanche or "bulk" breakdown and  $n$  is the rate of multiplication; both terms are constant for a device of a given type. These constants are determined for a particular transistor as follows:

For a common-base circuit using constant-current input, the collector current  $I_C$  is given by

$$I_C = \alpha M I_E + M I_{CBO} \quad (2)$$

where  $\alpha$  (alpha) is the short-circuit common-base current transfer ratio,  $I_E$  is the emitter current, and  $I_{CBO}$  is the collector-to-base leakage current. Both  $I_E$  and  $I_{CBO}$  are multiplied by the multiplication factor  $M$  because they cross the depletion layer (the ohmic leakage components of  $I_{CBO}$  which do not cross the depletion layer and are not affected by multiplication are not considered here).

If the operating point of a transistor in a common-base circuit is selected so that  $I_E$  is much greater than  $I_{CBO}$ , then equation (2) can be simplified as follows:

$$I_C \approx \alpha M I_E \quad (3)$$

The multiplication factor  $M$  is then given by

$$M = \frac{1}{\alpha} \cdot \frac{I_C}{I_E} \quad (4)$$

Because the collector current  $I_C$  is related to the multiplication factor  $M$ , which is in turn related to the collector-base voltage  $V_{CB}$ , particular values of  $M$  for values of  $V_{CB}$  can be obtained from the following rearrangement of equation (1):

$$\log \frac{M-1}{M} = n \log \frac{V_{CB}}{V_A} \quad (5)$$

This equation indicates that a log-log plot of  $(M-1)/M$  as a function of  $V_{CB}$  is a straight line having a slope  $n$  and a value of  $V_{CB}$  equal to the true avalanche breakdown  $V_A$  when  $(M-1)/M$  is unity, or when  $M$  approaches infinity.

### Total Alpha

Equation (3) shows that the "total alpha", or total gain factor, for a transistor in a common-base circuit is reflected by the product  $\alpha M$ . In addition to the multiplication factor  $M$ , therefore, the "total alpha" depends on the short-circuit current transfer ratio  $\alpha$ , which is given by

$$\alpha = \beta_0 \gamma \quad (6)$$

where  $\beta_0$  is a transport factor and  $\gamma$  is the emitting efficiency of the transistor.

The transport factor  $\beta_0$  is a measure of the extent of recombination that takes place in the base region of the transistor; it is given by

$$\beta_0 = 1 - \frac{1}{2} \left( \frac{W}{L} \right)^2; \quad L = \sqrt{Dt} \quad (7)$$

where  $W$  is the active base width,  $L$  is the minority-carrier diffusion length,  $D$  is the minority-carrier diffusion constant for the semiconductor material, and  $t$  is the minority-carrier life-time (i.e., the time required for 63 per cent of the minority carriers to recombine in the base region).

The emitting efficiency  $\gamma$  is the ratio of the carriers injected into the base from the emitter to the sum of these carriers plus the carriers injected into the emitter from the base; it is given by

$$\gamma = 1 - \frac{D_b W N_b}{D_e L_b N_e} \quad (8)$$

where  $D_b$  and  $D_e$  are the minority-carrier diffusion constants of the base region and the emitter region, respectively, and  $N_b$  and  $N_e$  are the carrier concentrations of the base and emitter, respectively.

In a practical transistor, the diffusion length  $L$  is much greater than the active base width  $W$ , and the emitter is much more heavily "doped" than the base (i.e., the emitter conductivity  $\sigma_e$  is much greater than the base conductivity  $\sigma_b$ ). As a result of the heavier "doping", the emitter carrier concentration  $N_e$  is much greater than the base carrier concentration  $N_b$ . Equations (7) and (8) indicate that for these conditions

( $L \gg W$  and  $N_e \gg N_b$ ) both the transport factor  $\beta_0$  and the emitter efficiency  $\gamma$  are approximately equal to unity.

Collector characteristics for a transistor operated in a common-base circuit with a constant emitter current are shown in Figure 1. The "total alpha" of the transistor,  $\beta_0 \gamma M$ , varies from a value of  $\beta_0 \gamma$  at low voltages, where  $\beta_0 \gamma$  is close to unity and  $M$  equals unity, to a value approaching infinity when  $V_{CB}$  equals  $V_A$  (because  $M$  approaches infinity at this voltage). Because stable operation can be achieved as long as the "total alpha" remains finite, operation of transistors in common-base circuits is permissible at all voltages up to the collector-base avalanche voltage  $V_A$ .

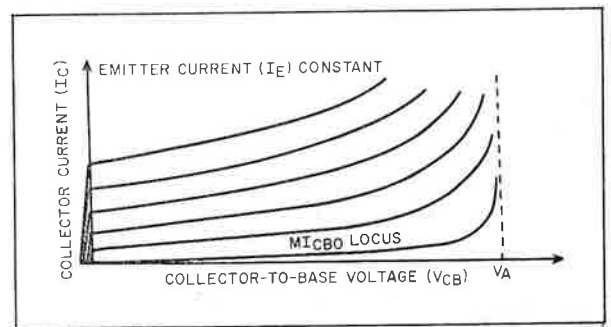

FIGURE 1.

### Common - Emitter Avalanche Breakdown

In common-emitter circuits, avalanche breakdown occurs at the collector-to-base voltage at which the common-emitter current transfer ratio  $\beta$  becomes infinite.  $\beta$  can be expressed in terms of the common-base current transfer ratio  $\alpha$ , as follows:

$$\beta = \frac{\alpha M}{1 - \alpha M} \quad (9)$$

$\beta$  becomes infinite when  $\alpha M$  equals unity (i.e., when  $M = 1/\alpha = 1/(\beta_0 \gamma)$ ).

Avalanche multiplication increases the number of carriers supplied to the collector side of the junction from the depletion layer. The base is then required to supply a similar number of new carriers to the depletion layer to maintain charge neutrality in the layer. At the collector voltage at which the number of carriers supplied to the depletion layer by the base because of multiplication just equals the number of carriers gained by the base through recombination (transport factor  $\beta_0$ ) plus an effective number of opposite-type carriers injected by the base (emitting efficiency  $\gamma$ )\*, the current transfer ratio becomes infinite because no base current is required to support

\*The injection of opposite-type carriers by the base is equivalent to a corresponding gain of similar carriers in the base.

collector-current flow.

As stated above,  $\beta$  becomes infinite when  $\alpha M$  equals unity, or when  $M=1/\alpha$ . Substitution of this value in equation (1) produces the following equation for  $\alpha$ :

$$\alpha = 1 - \left(\frac{V_{CB}}{V_A}\right)^n \tag{10}$$

This equation can then be solved for the value of  $V_{CB}$  at which  $\alpha M$  equals unity (this voltage is represented by  $V_{\alpha M=1}$ ), as follows:

$$V_{\alpha M=1} = V_A \sqrt[n]{1-\alpha} \tag{11}$$

For collector voltages smaller than  $V_{\alpha M=1}$ , base current  $I_B$  flows in the normal direction and  $\beta$  is positive. For voltage greater than  $V_{\alpha M=1}$ , however, the base-current is reversed and  $\beta$  is negative.  $\beta$  and "total alpha" are shown as functions of  $V_{CB}$  in Figure 2.

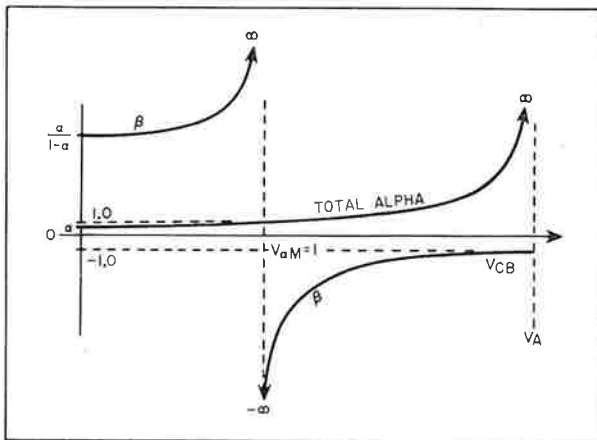

FIGURE 2.

The collector current  $I_C$  of a transistor operating in a common-emitter circuit with a constant-current input is given by

$$I_C = \beta I_B + (\beta + 1) M I_{CBO} \tag{12}$$

The collector characteristics for such operation are shown in Figure 3.

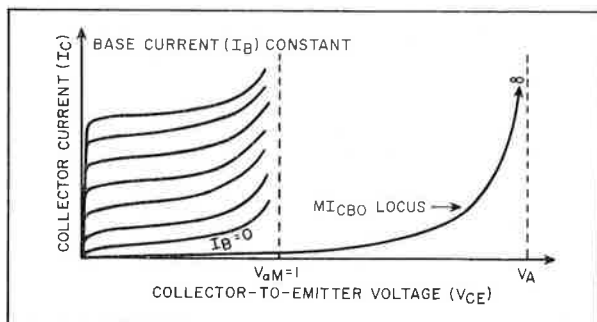

FIGURE 3.

Although the abscissa for these curves is collector-to-emitter voltage rather than the collector-to-base voltage previously used, no appreciable difference exists between the two except at low collector voltages, where multiplication is negligible in any case.

If negative feedback in the form of emitter resistance is applied to a transistor operating in a common-emitter circuit without constant-current input, as shown in Figure 4, the net effect is an increase in the avalanche breakdown. In the circuit of Figure 4,  $R_B$  is the series Thevenin equivalent of all external resistances presented to the transistor base terminal,  $R_E$  is the sum of both external and internal emitter resistances, and  $V_g$  is the voltage source or Thevenin voltage at the base terminal.

The base-to-emitter voltage  $V_{BE}$  can be assumed to be approximately zero, provided the internal base resistance is small compared to  $R_B$ . The base current  $I_B$  is then given by

$$I_B = \frac{V_g}{R_B} \tag{13}$$

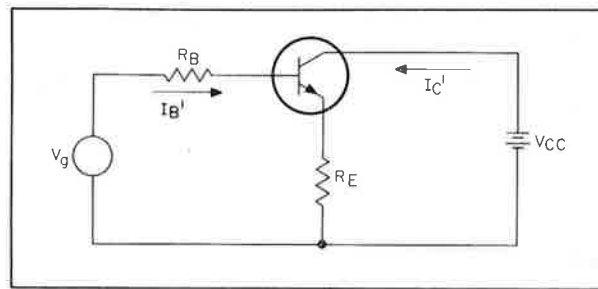

FIGURE 4.

The collector current  $I_C'$  for the circuit with external emitter resistance can be determined in terms of initial base current  $I_B$ , as follows:

$$I_C' = \beta I_B' = \frac{\beta R_B}{R_B + (\beta + 1) R_E} \times I_B \tag{14}$$

Because the input is a finite source voltage, the effect of the external emitter resistance is to reduce the output or collector current. An artificial current ratio  $\beta'$  can be introduced to account for the change in  $I_C$ , as follows:

$$\beta' = \frac{\alpha'}{1 - \alpha'} = \frac{R_B}{R_B + (\beta + 1) R_E} \times \beta \tag{15}$$

Equation (15) can then be solved to determine an artificial common-base current transfer ratio  $\alpha'$ , as follows:

$$\alpha' = \alpha \times \frac{R_B}{R_B + R_E} \tag{16}$$

This value of  $a'$  is not the true common-base current transfer ratio of the transistor, but it defines the feedback effect which results from the use of external emitter resistance when any type of source other than a pure current source is applied to the transistor in the common-emitter circuit. The term  $a'$  can be used to determine the common-emitter avalanche voltage for non-constant-base-current conditions when external emitter resistance is used. Combination of equations (11) and (16) provides the avalanche voltage, as follows:

$$V_{a'M=1} = V_A \sqrt[n]{1 - \frac{R_B}{R_B + R_E} a} \quad (17)$$

The collector characteristics for these conditions are similar to the characteristics shown in Figure 3, except that the voltage  $V_{aM=1}$  is replaced by the higher voltage  $V_{a'M=1}$  as defined in equation (17). If  $R_B$  becomes infinite or  $R_E$  becomes zero, the condition for constant-base-current operation is reached and  $V_{a'M=1}$  reduces to  $V_{aM=1}$ . If  $R_E$  becomes infinite or  $R_B$  becomes zero,  $V_{a'M=1}$  reduces to  $V_A$ , the common-base avalanche breakdown voltage. Therefore when a source voltage and external emitter resistance are used, the common-emitter avalanche breakdown voltage can vary from a low of  $V_{aM=1}$  to a high of  $V_A$ , depending upon the ratio of  $R_B$  to  $R_E$ .

#### Common - Emitter Voltage Breakdown as a Function of Circuit Conditions

The preceding discussion of common-emitter voltage breakdown considers only forward-bias conditions. Other types of breakdown may occur for circuit input conditions when no forward bias is applied. Several of these conditions are discussed below.

#### Resistive Source R

When a transistor is operated in a common-emitter circuit from a resistive source  $R$ , as shown in Figure 5, the collector current  $I_C$  is given by

$$I_C = \frac{MI_{CBO}}{1 - a_N \alpha_i} \left[ 1 + \frac{a_N (1 - \alpha_i)}{(1 - a_N) + \frac{K_T}{q} \frac{(1 - a_N \alpha_i)}{I_{EBO} R}} \right] \quad (18)$$

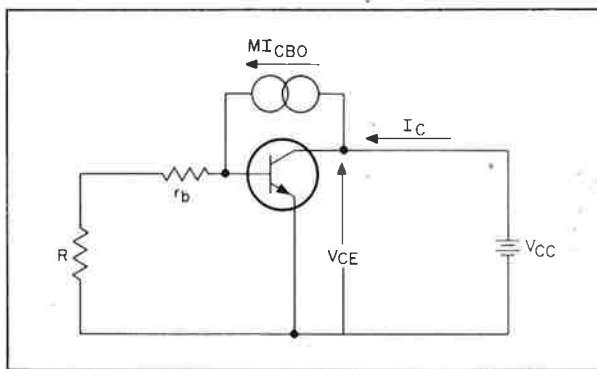

FIGURE 5.

where  $a_N$  is the normal common-base current transfer ratio for the transistor ( $a_N = \beta_{0Y}$ ),  $\alpha_i$  is the current transfer ratio for inverted operation,  $I_{EBO}$  is the emitter-to-base leakage current, and the term  $K_T/q$  is equal to 0.026 volt at 25 degrees centigrade.

The total collector leakage current  $MI_{CBO}$  divides at the internal base terminal; a portion flows through the internal base resistance  $r_b$  and the source resistance  $R$ , and the balance flows through the base of the transistor to produce the collector current given by equation (18). The voltage produced by the portion flowing through  $r_b + R$  provides a forward bias between the emitter and the base.

It is assumed that the intrinsic emitter-base diode has a step-function V-I characteristic with a threshold voltage  $V_d$ , rather than an exponential characteristic, and also that all leakage current flows through the external base current as long as the forward bias is less than  $V_d$ . For this approximate transistor model, emitter injection takes place when the emitter forward bias equals  $V_d$ , and collector-to-emitter voltage breakdown occurs. The breakdown condition is given by

$$MI_{CBO} (R + r_b) = V_d \quad (19)$$

Because  $M$  is related to  $V_{CB}$  and  $V_{CE}$ , equation (19) can be solved for  $V_{CE}$  for any given value of  $V_{CB}$ . The calculated value of  $V_{CE}$  would then be designated as the collector-to-emitter breakdown voltage with source resistance  $R$ , and would have the symbol  $BV_{CER}$ . The value of  $BV_{CER}$  is given by

$$BV_{CER} = V_A \sqrt[n]{1 - \frac{I_{CBO} (R + r_b)}{V_d}} \quad (20)$$

Equation (20) indicates that  $V_{CE}$  is inversely proportional to the logarithm of  $R$ . Therefore, the highest breakdown voltage occurs when  $R$  is equal to zero. This voltage is designated as the shorted-base breakdown voltage, and has the symbol  $BV_{CES}$ .

If the base is opened ( $R$  approaching infinity), the threshold voltage  $V_d$  is reached for any finite value of  $MI_{CBO}$ , and transistor operation is governed by the common-emitter current transfer ratio  $\beta$ . For this condition, the entire leakage current  $MI_{CBO}$  must flow through the transistor base to produce a collector current equal to  $(\beta + 1) MI_{CBO}$ . This lowest value of breakdown voltage occurs at the collector-to-emitter voltage at which  $\beta$  becomes infinite, which was previously defined as  $V_{aM} = 1$ .

The breakdown voltage for all other source-resistance conditions is greater than  $V_{aM} = 1$ ; i.e., when emitter injection starts, total alpha ( $aM$ ) is greater than unity, and  $\beta$  is negative. Figure 2 shows that when  $V_{CE}$  is greater than  $V_{aM} = 1$ ,  $\beta$  increases nega-

\*The intrinsic collector current  $I_C''$  is  $\beta$  times the intrinsic base current  $I_B''$ , for this case  $MI_{CBO}$ . The actual measured collector current is the intrinsic collector current plus the leakage current, i.e.,  $I_C = I_C'' + MI_{CBO}$  and  $I_C'' = \beta I_B'' = \beta MI_{CBO}$ . Therefore,  $I_C = \beta I_B'' + MI_{CBO}$ , which reduces to  $I_C = (\beta + 1) MI_{CBO}$ .

tively as voltage decreases. At breakdown, emitter injection occurs, and the collector current increases rapidly. This increasing current causes a decrease in collector voltage as a result of the presence of collector, emitter, and supply resistances. The decreasing collector voltage in turn causes an increase in  $\beta$  and collector current, so that the effect becomes cumulative. This effect produces a negative-resistance breakdown-voltage characteristic that becomes asymptotic to  $V_{\alpha M}=1$  when  $\beta$  is infinite.

The source-resistance breakdown characteristics are shown in Figure 6.

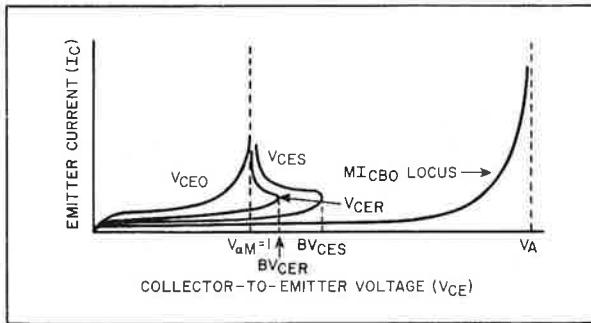

FIGURE 6.

**Reverse Bias Voltage Source**

When a reverse bias is applied between emitter and base, as shown in Figure 7, the collector breakdown voltage can be increased above the value  $BV_{CES}$ . As in the case of source resistance, no emitter injection takes place as long as the forward emitter bias is less than the threshold voltage  $V_d$ . Injection occurs when the drop across  $r_b$  resulting from  $MI_{CBO}$  is sufficient to overcome both the base supply voltage  $V_{BB}$  and  $V_d$ . This breakdown condition is given by

$$MI_{CBO} r_b = V_d + V_{BB} \quad (21)$$

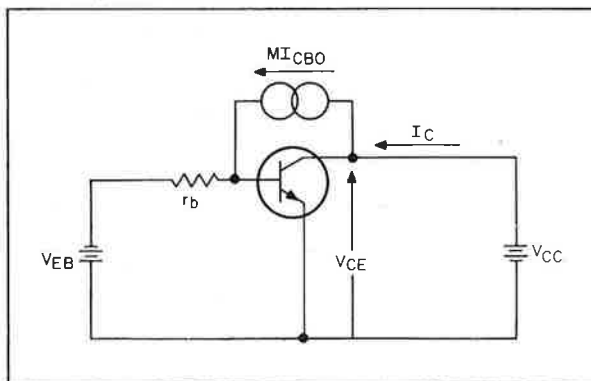

FIGURE 7.

An increase in  $V_{BB}$  increases the value of both  $M$  and  $V_{CE}$ . Figure 8 shows a series of breakdown curves for different values of  $V_{BB}$ . Negative resistance occurs when the transistor operates in the region of negative  $\beta$ , as discussed previously. The peak value of each characteristic is designated by  $BV_{CEX}$ . The value of  $BV_{CEX}$  is given by

$$BV_{CEX} = V_A \sqrt[n]{1 - \frac{I_{CBO} (R + r_b)}{V_d + V_{BB}}} \quad (22)$$

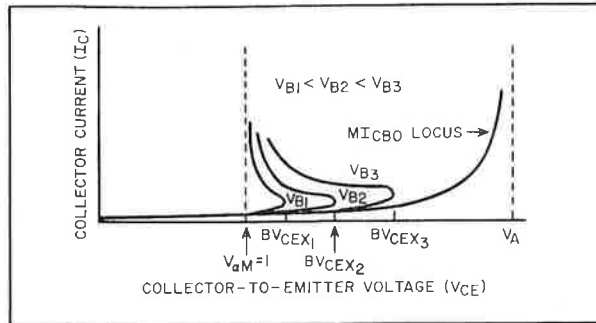

FIGURE 8.

**Transistor Operating Regions**

The various breakdown voltages discussed up to this point determine the operating regions for general-purpose transistors. In general, transistor characteristics can be divided into two regions of operation, as shown in Figure 9.

The limits of region A, the forward-bias region, are determined by the common-emitter breakdown voltage  $V_{\alpha M}=1$  and the maximum collector-current rating for the transistor. Operation anywhere in this region is permissible provided the peak dissipation ratings for the transistor are not exceeded. There are no restrictions on input-circuit conditions unless the region boundary is set by  $V_{\alpha M}=1$  rather than  $V_{\alpha M}=1$ ; in this case, the conditions discussed pre-

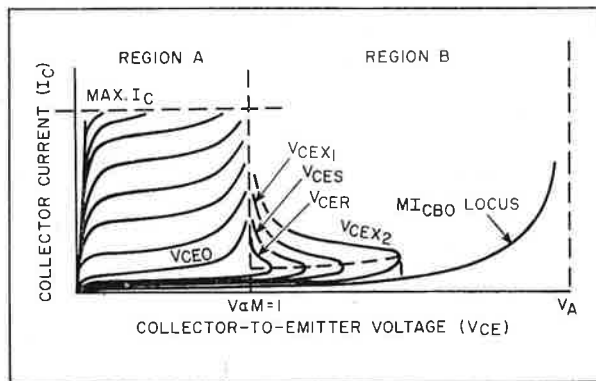

FIGURE 9.

viously apply.

The lower limit of region B, the negative-resistance is determined by the avalanche breakdown voltage  $V_{aM=1}$ , and the upper limit by the respective breakdown voltages for particular input conditions, i.e.,  $BV_{CES}$ ,  $BV_{CER}$ ,  $BV_{CEX}$ , etc.

**Additional Considerations**

In the previous discussion of common-emitter avalanche breakdown voltage, the term  $V_{aM=1}$  was assumed to be independent of collector current. However,  $V_{aM=1}$  is a function of the common-base current transfer ratio  $a$  (as shown in equation 10), which varies with  $I_C$ . It follows, therefore, that  $V_{aM=1}$  must change with  $I_C$ .  $\beta$  and  $a$  vary with  $I_C$  differently for abrupt- and graded-junction transistors. Figure 10 shows the variation of  $\beta$  for typical transistors.

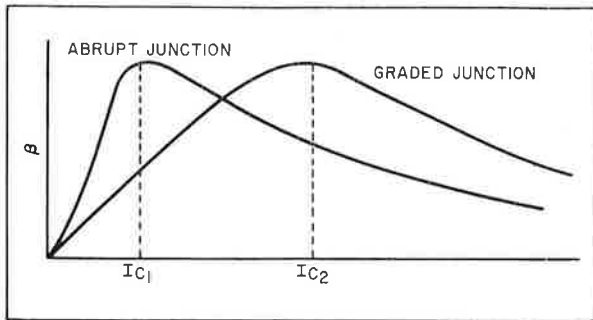

FIGURE 10.

Because the minimum value of  $V_{aM=1}$  occurs at the

peak of the curves shown in Figure 10, it is possible to construct a locus of points on the  $V_C$ - $I_C$  curves of a transistor where the total alpha  $aM$  is equal to unity, as shown in Figure 11. This locus curve has only a positive-resistance slope for abrupt-junction types, but has both positive and negative-resistance slopes for graded-junction types.

Because both the forward-bias and reverse-bias curves become asymptotic to  $V_{aM=1}$  for common-emitter operation, this variation of  $V_{aM=1}$  with  $I_C$  modifies all the breakdown curves. It also explains why some forward bias curves, such as  $V_{CEO}$  can have a negative resistance component for some types of transistors. This effect is observed for most diffused

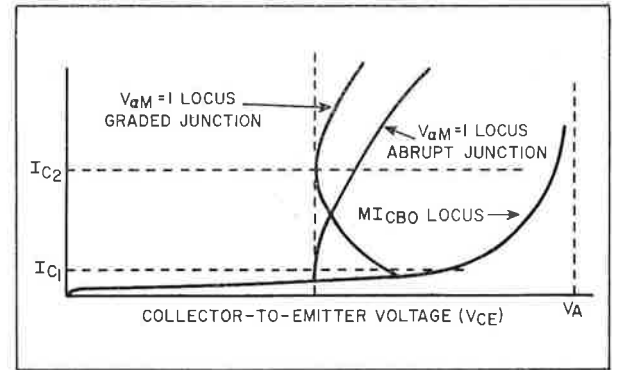
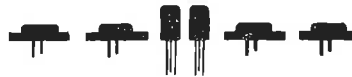

FIGURE 11.

types that have graded junctions; because alloy transistors have abrupt junctions, these types do not normally have negative-resistance forward-biased voltage characteristics.



# THE TR8

**A compact, low-cost,  
transistorized stereo amplifier**

## Introduction

We recently introduced to Australia a new concept in drift power transistors for audio amplifier applications, when we presented the TR24 unit (Radiotronics, May, 1962). The TR24 unit used type 2N2147 transistors, and it was mentioned at the time that another transistor of the same family, the type 2N2148, was also available.

The type 2N2147 is especially suited to Class B configurations, and that indicated its choice for the TR24 unit. The type 2N2148, on the other hand, is especially suited to Class A circuits. This amplifier uses 2N2148's as Class A amplifiers in the output stages.

This unit now being described does not perhaps qualify for the description of high fidelity as normally accepted in these pages—that is, having 1% total harmonic distortion or better at the rated output power. The TR8 does, however, provide a good quality performance at a reasonable cost, as will be seen below from the stated performance figures, and to that extent fills a very real need.

We have mentioned before in these pages that a very high standard of performance is very interesting; when economics are concerned, a highly acceptable performance can be achieved by adopting a little latitude in specifying the performance figures required. This can be done and still produce an amplifier that sounds good.

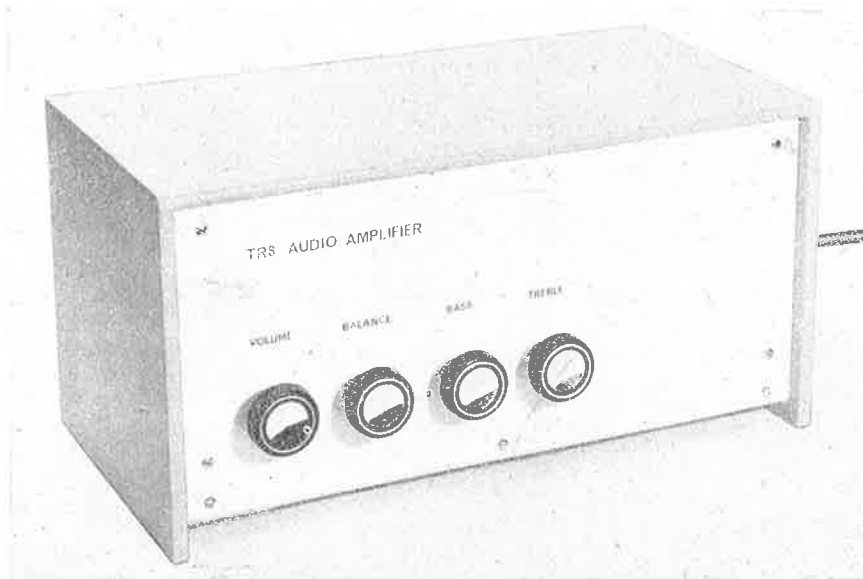

Photograph of the completed TR8 amplifier in the simple case described in the text.



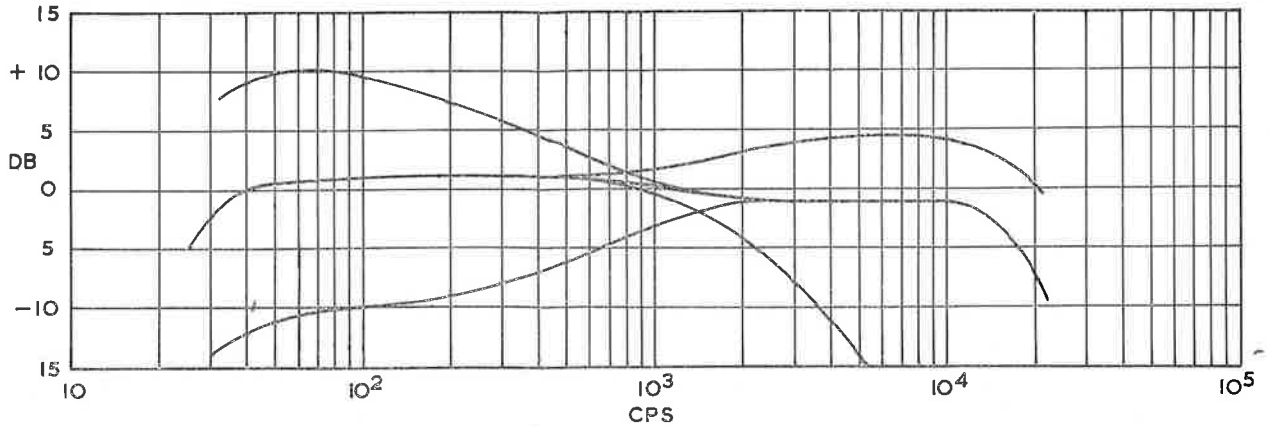

Frequency response curves of the TR8 amplifier, showing the operation of the tone controls.

It must also be remembered that although the distortion figures of an amplifier are usually quoted at full power output, when the amplifier is used in the home, it customarily runs at only a fraction of the rated power output, at correspondingly lower distortion figures.

This amplifier then is rated at four watts output per channel at low distortion. The amplifier will accept a variety of load impedances, the accompanying curves showing the distortion levels for various outputs and three values of load, 4, 8 and 16 ohms. A built-in preamplifier offers basic facilities for use with a crystal pickup cartridge, and the input circuit can be modified, if necessary, to accept a ceramic cartridge.

**Circuit Description**

The accompanying circuit diagram shows the complete amplifier, both channels, with power supply. The output stage of each channel uses a 2N2148 drift power transistor operated in Class A condition. This is preceded by a driver and predriver stage, using two 2N408's, with direct coupling used throughout. A tapped output choke is provided for coupling the loudspeaker to the amplifier, and it should be noted that the loudspeaker leads will consequently carry the collector supply potential of about 20 volts. Care should be taken, therefore, not to allow these leads to short circuit to ground, as this may damage the power supply and dynamic filter.

A special winding on the tapped output choke is used for feedback purposes, the feedback signal being taken back to the base of the predriver stage. Approximately 20 db of negative feedback is provided. Two 1N2858 silicon diodes are used for biasing purposes, one in the emitter lead of the 2N408 predriver stage, and one in the emitter lead of the 2N2148 output stage.

These diodes are essential for thermal stability, and cannot be omitted. The diode in the emitter lead of the 2N2148 ensures that the power transistor can be turned off, by acting as a battery to hold the emitter at approximately -0.7 volts with respect to the junction of R49 and R51. The diode in the emitter lead of the 2N408 pre-driver stage serves as a reference for the emitter so that essentially the whole of the voltage developed across R53 appears at the base of the predriver transistor.

The preamplifier, which forms an integral part of this unit, is essentially the same as the pre-amplifier presented with the TR24 unit. As

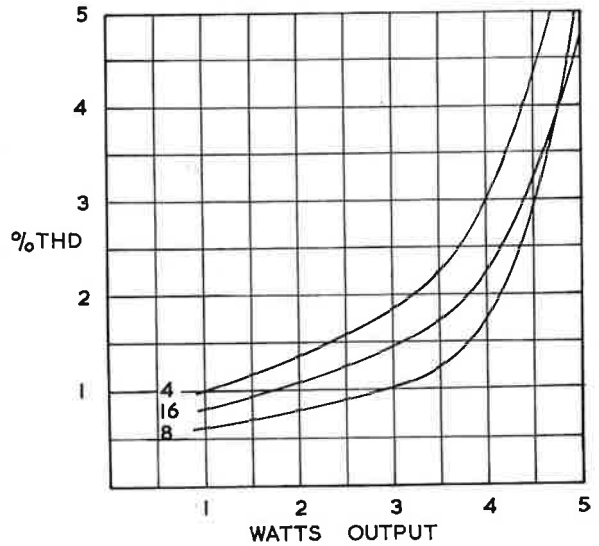

Power output versus total harmonic distortion curves for the TR8 amplifier unit for load resistances of 4, 8 and 16 ohms.

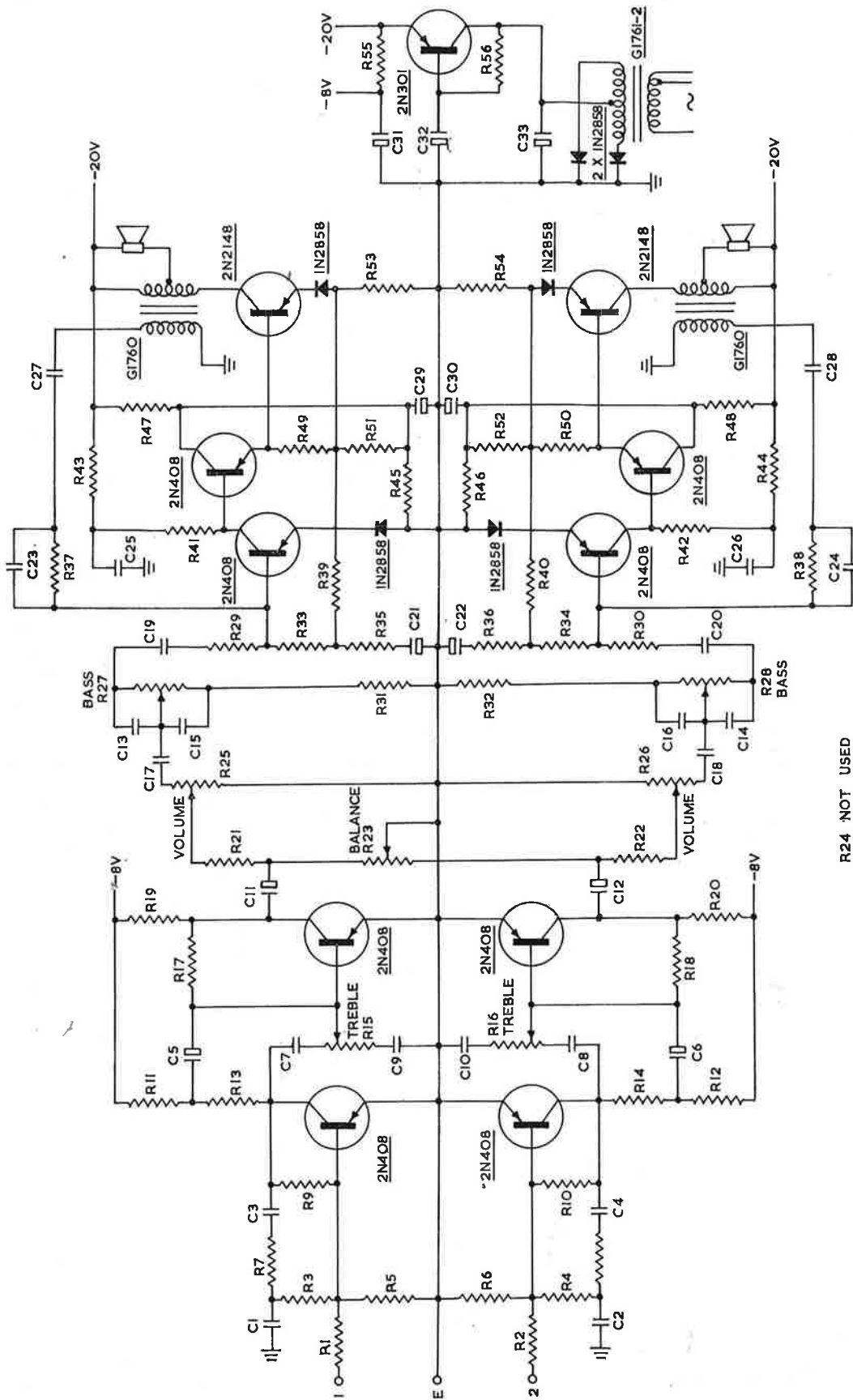

R24 NOT USED

Circuit diagram of the TR8 transistorized stereo amplifier with integrated preamplifier.

## PARTS LIST

### Semiconductors

2	AWV transistors 2N2148
1	AWV transistor 2N301
8	AWV transistors 2N408
6	AWV silicon diodes 1N2858

### Resistors

All resistors are  $\frac{1}{2}$ -watt, 10% tolerance except where otherwise stated.

R1, R2	100 K ohms
R3, R4	33 K ohms
R5, R6	10 K ohms
R7, R8	33 K ohms
R9, R10	220 K ohms
R11, R12	27 K ohms
R13, R14	1.2 K ohms
R15, R16	Dual ganged potentiometer, 10 K ohms, log.
R17, R18	39 K ohms
R19, R20	1 K ohm
R21, R22	270 ohms
R23	Potentiometer, 10 K ohms, linear
R24	Not used
R25, R26	Dual ganged potentiometer, 5 K ohms, log
R27, R28	Dual ganged potentiometer, 10 K ohms, linear
R29, R30	4.7 K ohms
R31, R32	270 ohms
R33, R34	4.7 K ohms
R35, R36	180 ohms
R37, R38	220 K ohms
R39, R40	1 K ohm
R41, R42	4.7 K ohms
R43, R44	5.6 K ohms
R45, R46	150 ohms
R47, R48	150 ohms, 2 watt

R49, R50	39 ohms
R51, R52	100 ohms
R53, R54	1 ohm, 1 watt
R55	1000 ohms, 1 watt
R56	100 ohms, 1 watt

### Capacitors

C1, C2	1800 pf, ceramic
C3, C4	0.047 $\mu$ f, 25 vw, ceramic
C5, C6	5 $\mu$ f, 12 vw, electrolytic
C7, C8	0.1 $\mu$ f, 25 vw, ceramic
C9, C10	0.47 $\mu$ f, 25 vw, ceramic
C11, C12	5 $\mu$ f, 12 vw, electrolytic
C13, C14	0.1 $\mu$ f, 25 vw, ceramic
C15, C16	0.47 $\mu$ f, 25 vw, ceramic
C17, C18	2 $\mu$ f, 3 vw, electrolytic
C19, C20	2 $\mu$ f, 3 vw, electrolytic
C21, C22	25 $\mu$ f, 3 vw, electrolytic
C23, C24	10 pf, ceramic
C25, C26	100 $\mu$ f, 12 vw, electrolytic
C27, C28	0.047 $\mu$ f, 25 vw, ceramic
C29, C30	50 $\mu$ f, 6 vw, electrolytic
C31	50 $\mu$ f, 12 vw, electrolytic
C32	1000 $\mu$ f, 25 vw, electrolytic
C33	2 x 1000 $\mu$ f, 25 vw, electrolytic

### Transformers

2	Output chokes, M.S.P. sample type No. G1760
1	Mains transformer, M.S.P. sample type No. G1761-2. Primary 0-220-240 volts, secondary 40 volts centre-tapped at 1.6 amperes.

### Miscellaneous

14-gauge aluminium panels,  $\frac{1}{2}$ " x  $\frac{1}{2}$ " aluminium angle, loudspeaker and pickup plugs and sockets, knobs, matrix board and pins, tag strips, hardware.

presented here, the unit is suitable for use with crystal pickup cartridges of the "Ronette" or similar types which require a flat response from the amplifier; that is, no further equalization is required in the amplifier itself. Where units not possessing this characteristic are used, the manufacturer's recommendations should be followed.

An alternative input circuit was presented with the TR24 preamplifier unit, and may be used here if required. (See *Radiotronics*, June, 1962.) The alternative circuit provides equalization for a representative ceramic cartridge.

The facilities provided in the preamplifier are a gain control, balance control, and bass and treble boost and cut controls. These are the

minimum facilities required, and can be added to as the individual builder wishes. He can, for example, add a mono/stereo switch, an input selector switch, and so on.

The output stage of this amplifier has been designed to accept loads of between 4 and 8 ohms, connected as shown on the circuit diagram. It was found, however, that a 16-ohm load could be used, still with acceptable levels of distortion, by connecting the 16-ohm load directly across the whole of the output choke primary winding; that is, directly between the collector of the output transistor and the collector supply line. Note that if this is done, the choke is still required for feedback purposes and cannot be discarded.

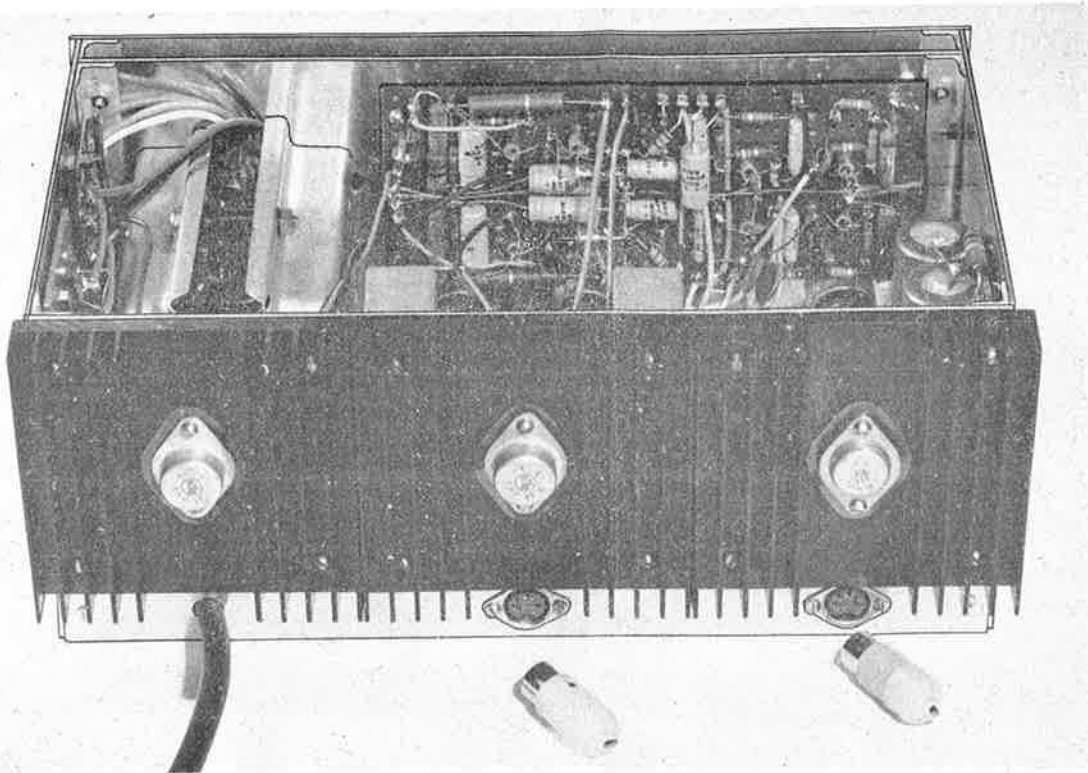

Close-up of the rear of the front sub-panel, showing the arrangement of the controls and the matrix board which carries most of the circuit.

The power supply for the amplifier is a conventional full-wave rectifier system, with the addition of a dynamic filter, which uses a 2N301 transistor. By now, readers will be familiar with this arrangement, and those who have tried it will realise its value as far as reducing hum and noise levels are concerned. Further, this good performance is achieved at a cost comparable with more conventional means, because the cost of the 2N301 transistor is at least partially offset by the saving in a filter inductor and extra filter capacitors.

### Construction

With semiconductors we are dealing with a new type of device, and this demands a new approach to construction problems. The old conventional method of construction using a chassis seems in most cases totally unsuited to the requirements of semiconductors. We are therefore exploring new layouts and construction methods more suited to the particular problems encountered.

One example of this thinking was seen in the TR24 unit, which reverted almost to a bread-board type of construction. Those who have been in the industry a few years will realise that this is nothing new, as there was a time when all

radio sets and amplifiers were built this way. The point is that this approach greatly simplified construction.

In the TR8 unit we have gone a little further, and it may be interesting to examine briefly the thoughts behind the solution presented here. At the outset, let us say that ours is obviously not the only solution. The requirement here was for front panel space for the controls, the accommodation of a fairly large mains transformer and the two output chokes, and space for three type 7001 4" x 4" heat sinks. The heat sinks are needed for the 2N2148 and the 2N301 transistors.

Because the heat sinks required free access for atmospheric cooling, they were mounted side by side at the rear of the unit with the fins running vertically. This then decided the minimum width of the unit at 12 inches. The height of the unit was then fixed at 5 inches to allow 1 inch below the heat sinks at the back of the unit for input and output sockets and main cable entry. The mounting holes for the output chokes very conveniently appeared at 3-inch centres, the same as the fixing holes for the heat sinks, so that the same holes could be used.

The driver, predriver and preamplifier stages are all assembled on a section of matrix board

12 holes wide by 28 holes long, i.e., about  $3\frac{1}{8}$ " x  $7\frac{1}{8}$ ". Incidentally, the whole of this portion of the amplifier is completely assembled before being mounted in the unit. It was found that the matrix board assembly, the four controls and the mains transformer could be accommodated on a 5" x 12" area; that is, within the area already determined by the size of the back panel.

The only remaining factor was the spacing between the front sub-panel and the back panel. This was readily determined at  $5\frac{3}{8}$ " to allow clearance for the mains transformer and the output chokes.

Several readers have apparently foundered on the difficulty of making their units have that "finished" look that not only enhances their work but pleases other members of their families who may have to sit and look at the units. For their benefit, therefore, we extended ourselves to show a solution here also.

With the size of the amplifier now fixed at 12 inches wide and 5 inches high, a very simple cabinet was constructed to these dimensions, with allowance for clearance. The cabinet was made  $6\frac{1}{2}$ " deep from front to back, the side walls were carried down so that the bottom shelf was raised about half an inch, and the front of the lower

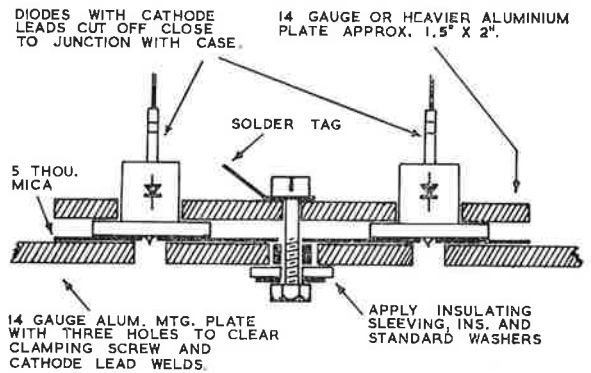

NOTE: FOR MAXIMUM EFFICIENCY OF COOLING, LIGHTLY SMEAR BOTH SIDES OF MICA PLATE WITH SILICONE GREASE BEFORE FINAL ASSEMBLY. FOR GROUNDED + SUPPLY, OMIT MICA INSULATOR.

**Method of providing heat sink for 1N2858 silicon diodes and similar types. Note that in the case of the TR8 amplifier, where a grounded positive supply is required, insulation of the centre fixing screw and provision of the mica insulating plate are not required.**

shelf was also set back about  $\frac{3}{8}$ ". This cabinet was made from scrap plywood salvaged from a packing case, just to show what can be done. This cabinet could be filled, primed and lacquered

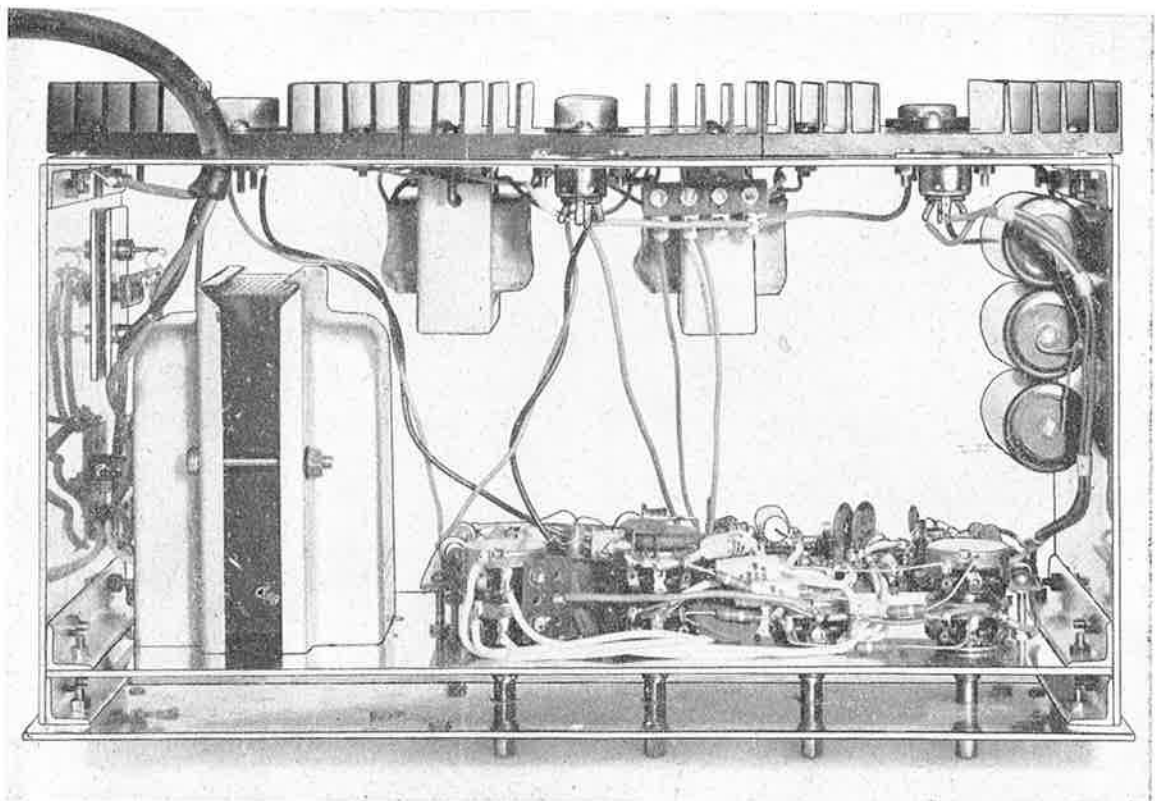

A view through the unit, showing the general layout and method of construction.

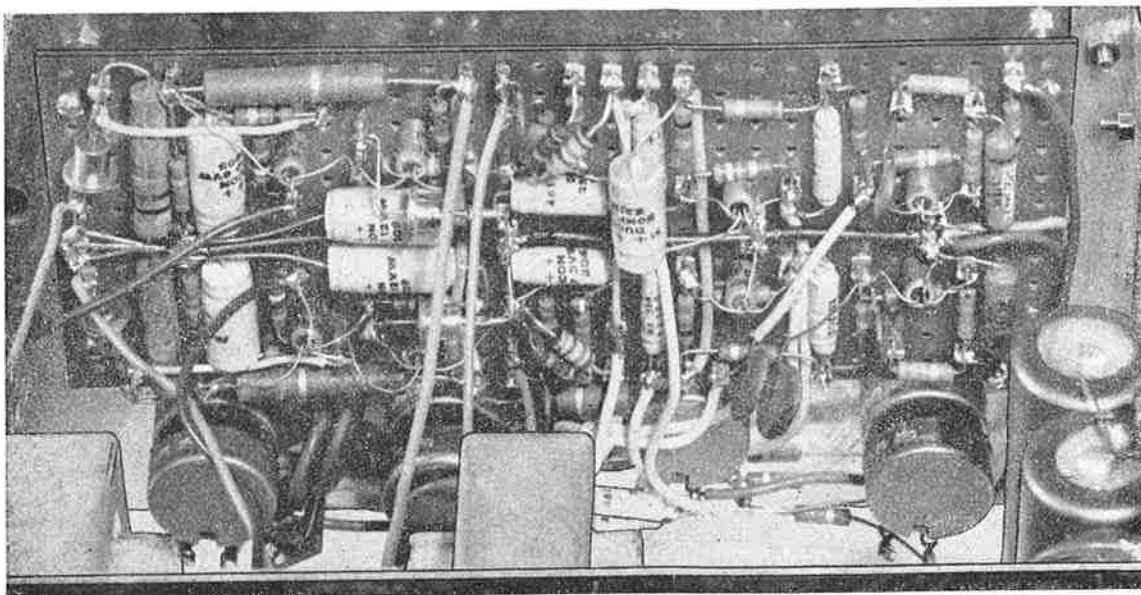

**Component layout of the matrix board section. This assembly should be completed before being assembled into the main section of the amplifier.**

(the new aerosol paint sprays are good for this size job), or, as in our case, the cabinet was covered with fabric-backed plastic sheeting of the type used for upholstery; a lightweight fabric was used. The use of plastic offers a wide choice of colours and textures.

To hold the completed amplifier in the cabinet, the front panel of the amplifier was extended downwards by half an inch. When the amplifier is in place in the cabinet, it is held by means of three plated screws passing through the front panel into the lower shelf of the cabinet, whilst the depth of the cabinet is such that the heat sinks protrude at the rear, with the back panel coming flush with the rear edge of the cabinet.

The mechanical construction of the amplifier will be readily seen from the accompanying photographs. Five 14-gauge aluminium panels are used, held together with six 5-inch lengths of  $\frac{1}{2}$ " x  $\frac{1}{2}$ " aluminium angle. The front panel size is 12" x 5 $\frac{1}{2}$ ", the front sub-panel and rear panel 11 $\frac{5}{8}$ " x 5", and the two side panels 6" x 5". The size of the front sub-panel and rear panel is reduced from 12" to 11 $\frac{5}{8}$ " so that when the unit is assembled, the side panels will be slightly recessed, with the front panel and the outer heat sinks protruding slightly. This was done so that the screw-heads on the side panels would not foul the sides of the cabinet.

This rather long description has been primarily intended to assist those with less experience in this type of work. It emphasises

one big fact: the usefulness of giving some thought to the entire plan before rushing into construction. Playing this sort of music by ear is very risky and can lead to disappointment and frustration. The general plan should always be sketched out and dimensions checked, with the exact location of each major component determined before actual construction starts.

One last word on construction. The two silicon diode rectifiers must be heat-sinked to hold their temperature down, as the collector supply drain is of the order of 1.5 amperes. An accompanying drawing shows a good way to do this, noting the instruction on the drawing that where a grounded positive supply is required, as in this case, the mica insert and insulation of the clamping screw are not required.

### Performance

The rated output per channel of this amplifier is four watts. The distortion level will vary not only with the output power drawn from the amplifier, but with the value of load impedance used. An accompanying curve, therefore, is used to tell the whole story in this regard. It will be seen that the use of a 4-ohm load gives the worst performance at the full rated power output; but even here, the total harmonic distortion is only 3%. It is of greater significance that at the 2-watt level, the total harmonic distortion with all three loads is better than 1.5%, whilst at the 1-watt level the performance in all cases is 1% or better. These figures are acceptable and will provide pleasant listening.

It should be noted that the distortion figures quoted are overall system distortion figures; that is, they include distortion introduced in the pre-amplifier also. The same remarks apply also to the frequency response of the amplifier. The accompanying curves tell the frequency response story. With the tone controls in the neutral positions, the response of the complete system is  $\pm 1$  db from 35 cps to 10 Kc. Response is 3 db down at 30 cps and 14 Kc.

Turning to the tone controls, the BASS control gives 10 db of bass boost and cut at 50 cps, whilst the TREBLE control gives a 5 db boost at 10 Kc and a cut of approximately 20 db. This arrangement provides all the tone control that is likely to be usable with realism, consisting as it does of moderate bass control, a small degree of treble boost, and ample treble cut.

The input level required to drive the amplifier to 4 watts output is of the order of 175 millivolts, using the input circuit shown in the circuit diagram. The hum and noise level is gratifyingly low at  $-64$  db, mainly due, of course, to the use of the dynamic filter. Crosstalk is better than 50 db down with one channel fully driven.

### Summary

This amplifier with integrated preamplifier offers a compact low-power package at a reasonable cost. The power level is sufficient for domestic use, the frequency response is adequate, and the distortion levels are acceptable. Due to the simplicity of construction, this unit can be recommended even to those who have as yet had little constructional experience.



## NEW RELEASES

### N1047M

In recent years there have been a number of fundamental technical advances in the field of low noise travelling wave tubes which have resulted in the reduction of noise figures in the 1 to 5 Gc region from the region of 6 db to between 3 and 4 db. Consistent with their policy in keeping in the forefront, EEV have been active in following and contributing to these new developments, and the N1047M, soon to go into production, is a representative example of their rapidly expanding activities in this field. The N1047M is designed for operation in the frequency range 2.7 to 3.5 Gc, over which band the noise figure has a maximum value of 4.5 db. The high saturation output power of this type of tube—greater than 1 mw—and the small signal gain of 23 db, contribute to making it suitable for application where both weak and strong signals are received simultaneously. Typical applications

include use as a signal amplifier in radar receivers, the second rf amplifier in Satellite Communication equipment, an if amplifier for millimetre wave receivers, and any other application requiring a low noise factor coupled with a relatively broad bandwidth demanding high reliability.

### EEV FX294

EEV announce the introduction of a new triode hydrogen thyratron, the FX294, of extremely rugged construction. It has a short recovery time, and is therefore suitable for pulse operation at repetition frequencies greater than 10 Kc. The maximum anode current is 60 ma mean and 35 amps peak. The valve is capable of withstanding a shock of 40g for 10 milliseconds, a sustained acceleration of 20g for three minutes, and a vibration acceleration rising from 3g at 20 cps to 11g to 50 cps, then levelling to 20g from 150 cps to 5 Kc.

# A USEFUL OUTPUT METER

By B. J. Simpson

## Introduction

This useful unit started off when I was busy with an output-transformerless transistorized audio amplifier. As readers will be aware, amplifiers of this type will in general accept a wide variety of load impedances, and it is therefore necessary to test them with all possible loads, say 4, 8 and 16 ohms. Further, the unit was a stereo amplifier, so that a load was required for each channel. When I was engaged on this job, the only output meter available provided only one load and had a full scale deflection of 5 watts, which was insufficient.

I got rather tired of selecting resistors for the various loads required and using them with a shunt voltmeter, mentally converting the voltage readings into watts. As this sort of thing was likely to happen frequently in the future, this simple output meter was conceived. This unit not only has a selection of loads, but a meter calibrated directly in watts, which can be switched to either load as required.

## The Meter

Most commercial output meters use a fixed load resistance and a multiple-tapped transformer to provide a wide range of loads, whilst the meter reads output power in watts. This arrangement, whilst it greatly simplifies the metering portion of the unit, calls for a high-grade transformer. As this unit had to be simple, and only three values of load resistance were required, it was decided to use fixed resistors connected directly to the amplifier output, thus dispensing with the transformer. This, on the other hand, raised another problem, that the full scale reading of the meter for a given output power will of course vary with the value of the load. This

meant that the multipliers or shunts used with the meter would have to be switched not only to vary the range of the meter, but according to the value of the load resistance being used.

It was decided early in the piece that the indication of power in the load would be a voltmeter across the load, and not an ammeter in series with the load. In theory, of course, either method would be satisfactory, but in practice it was decided that the voltmeter method would be the better. The reasons were that it is in general easier to solve the problem of multiplier resistors than that of shunt resistors, as far as the actual acquisition of the components is concerned, and that the switching involved naturally indicated that switching multipliers would be inherently less prone to trouble than switching shunts. In fact, as will be seen later, a very simple solution to the problem of multiplier resistors was found.

The basic arrangement of the meter took shape, therefore, as dual 4, 8 and 16-ohm loads connected to the input terminals through a load selection switch. A voltmeter, calibrated directly in watts, could then be switched to either load as required. The wattmeter came up with a three-position switch, providing full scale deflections of 5, 15 and 50 watts. As shown in the circuit diagram of the unit, a spare pole on the load selecting switch also selected one of three sets of three multiplier resistors for the meter, according to the value of the load resistor selected.

## Finding the Parts

Having decided the basic plan, the next step was a visit to the "junk" box. This useful helper yielded four large 100-watt wirewound resistors, the original purpose of which was long forgotten.



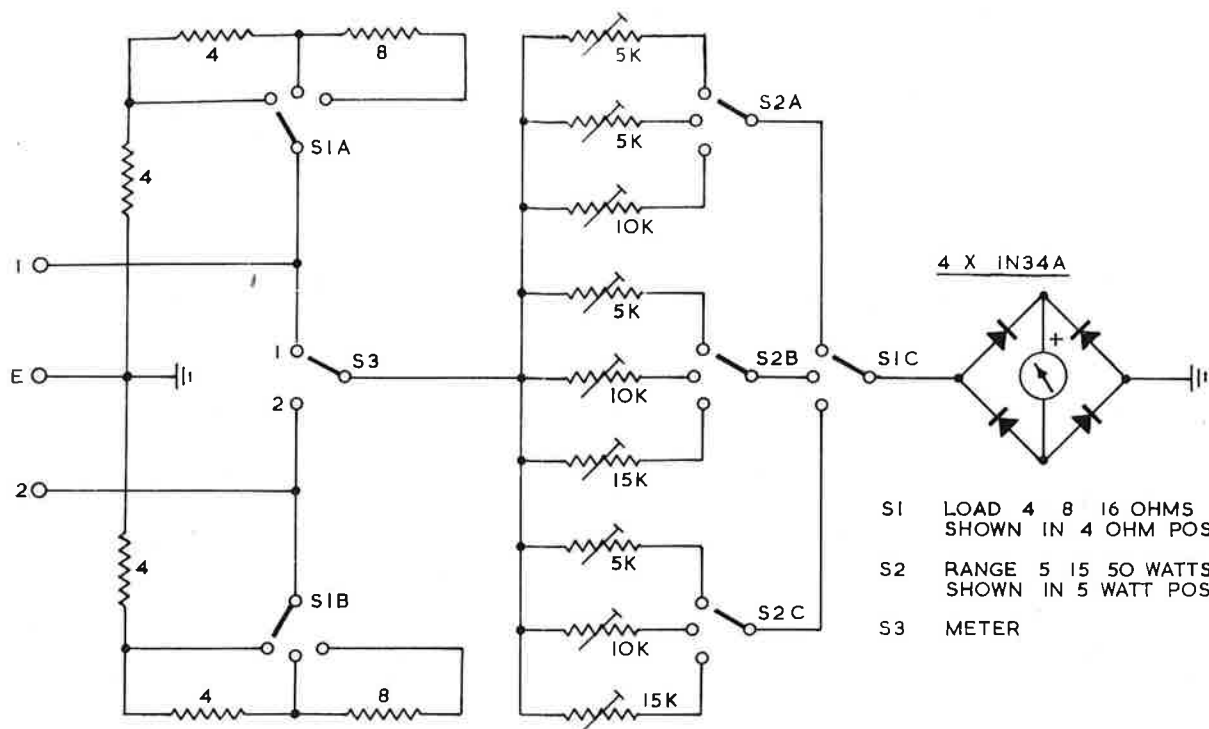

Circuit diagram of the output meter.

There were two fixed 6-ohm units, and two 10-ohm units with provision for tapping clips. Each load was therefore made up of one 10-ohm unit with taps at 4 and 8 ohms, together with a 6-ohm unit in series for 16 ohms. These large resistors are usually very close to their nominal value, certainly close enough for this sort of purpose, so that the only thing to be done was to fix the taps in the right places. If you want to build this unit and have to buy the resistors, I feel sure that the resistor makers would be quite happy to fix the taps in the right places for you if required.

The next item to be unearthed was an old 1-0-1 milliamp centre-zero meter. This unit was stripped down, the return springs adjusted to bring the pointer to the normal zero position for a single-polarity meter, and it ended up as an 0-2 ma meter or thereabouts. A new scale was provided, as described later. As the meter was a dc unit, a rectifier had to be provided, and four 1N34A's were selected for this purpose, connected in bridge formation.

Having found the load resistors, certainly the largest units in the instrument, the size of the case could be determined. The resistors were about 11 inches long, and it was found that everything could be fitted quite well into a standard MC67 metal case. The removable panel

that comes with the case was used as the back of the instrument. The problem remained of selecting the nine multiplier resistors, and of providing a new scale for the meter calibrated in watts.

Switching of loads and meter ranges is achieved in two identical three-pole three-way switches. M.S.P. "Oak" switches type AK19213 were used in both positions.

As mentioned above, the load resistors used in this instrument were 100-watt units because they happened to be available. It could be argued that as the full load capacity of the unit is 50 watts, then the load resistors could be of this rating. This is not quite true, as in the case of the 10-ohm tapped units, there will be cases where a maximum of 50 watts is being developed in less than half of the unit. This means that it would appear that the resistor could be run over the ratings. However, the wattage ratings for the type B coating components suggested for the unit are taken for a temperature rise of 250°C; as this temperature is unlikely to be reached, the situation can be tolerated.

Further, with the 100-watt rating components, they will in most cases be underrun, which is a good thing as the temperature rise and therefore their variation of values, will be kept to a

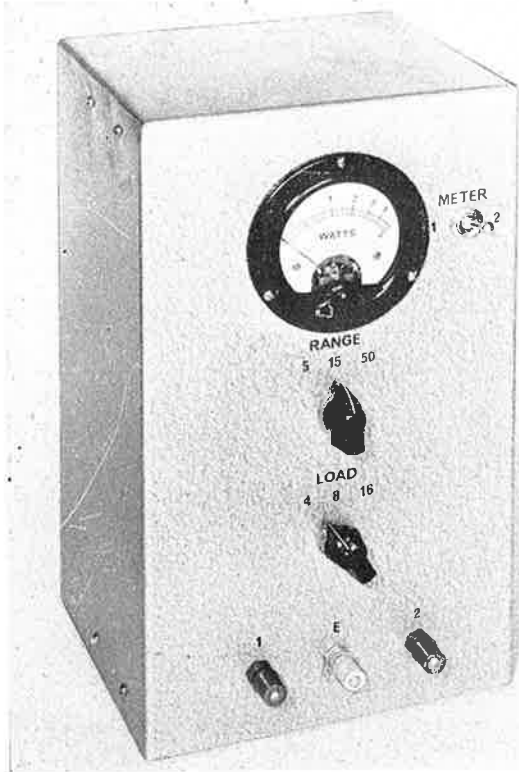

The output meter.

minimum. When looking up the specifications of suitable resistors, it appears that since the old units I found were made, improved techniques have allowed the sizes of the resistors to be decreased. Suitable types now available have the ceramic tubes only  $6\frac{1}{2}$ " long and the mounting centres at  $7\frac{1}{2}$ ". This means that the unit could, if required, with today's parts, be built into a smaller case, such as the MC7.

### Determining Circuit Values

Having decided that loads of 4, 8 and 16 ohms would be provided, and that the meter would be calibrated in full scale deflections of 5, 15 and 50 watts, the next step was to determine the values of the multiplier resistors for the meter. To do this, it was first necessary to calculate the voltage ranges across the loads corresponding to the already stated wattage scales.

These figures are readily calculated from the  $E^2/R$  formula, and produced results as follows: For the 16-ohm load, voltages are 9.0, 15.49 and 28.3 for 5, 15 and 50 watts respectively; for the 8-ohm load, the voltages are 6.32, 11 and 20, and for the 4-ohm load, 4.45, 7.7 and 14.14 respectively. With a 2 ma full scale deflection meter, this meant that the values of the multiplier resistors plus meter and rectifier resistances

would be: for the 16-ohm load, 4,500, 7,745 and 14,150 ohms; for the 8-ohm load, 3,160, 5,500 and 10,000 ohms; for the 4-ohm load, 2,225, 3,850 and 7,070 ohms respectively.

In the case of my meter, the movement resistance was quite low at 16.5 ohms, and for the purpose of this application, the forward resistance of the 1N34A diodes could be neglected. Multiplier resistors of the values stated above less 16.5 ohms would therefore be required. But because resistors of close tolerance at the values required would have to be ordered specially, it was decided to get around this problem in another way.

Small preset potentiometers were used as multipliers, three values being used, 5K, 10K and 15K ohms, in each case the next highest value above that of the required multiplier being chosen. There is no problem of dissipation here, and the stability of the potentiometers should be adequate over reasonable periods of time. Type TE units or equivalent types were chosen; these units are mounted with two press-over tabs and have no shaft, being adjusted by means of a screwdriver slot.

### The Meter Scale

Because the meter scale calibrated in watts will be non-linear, it was necessary to calculate the law of the scale before the preparation of the new scale could be started. Once the law is calculated for one range, the other ranges will fall into place through a simple process of multiplication. Given then that the full scale deflection of 5 watts into the 16-ohm load corresponds to a voltage reading across the load of 9.0 volts, this figure is designated 100% deflection.

It was then necessary to calculate the voltage readings across the load corresponding to other power readings, enough to draw the law of the scale. Voltage readings were calculated at 8.0, 6.92, 5.65, 4.0 and 2.82 volts, representing respectively 4, 3, 2, 1, 0.5 watts into the load. In turn, these figures represent respectively 88.5%, 77%, 63%, 45.5% and 31% full scale deflection. From this data a graph could be prepared of power versus percentage meter deflection. From the spot readings calculated, and interpolating with the aid of the graph, the preparation of the scale then became a simple mechanical exercise.

The graph used is reproduced here because it could be used for any meter and any full scale wattage reading. It relates percentage meter deflection to a scale of watts; by multiplying the watts scale by any required factor, the meter deflection percentage corresponding to any wattage reading can be determined.

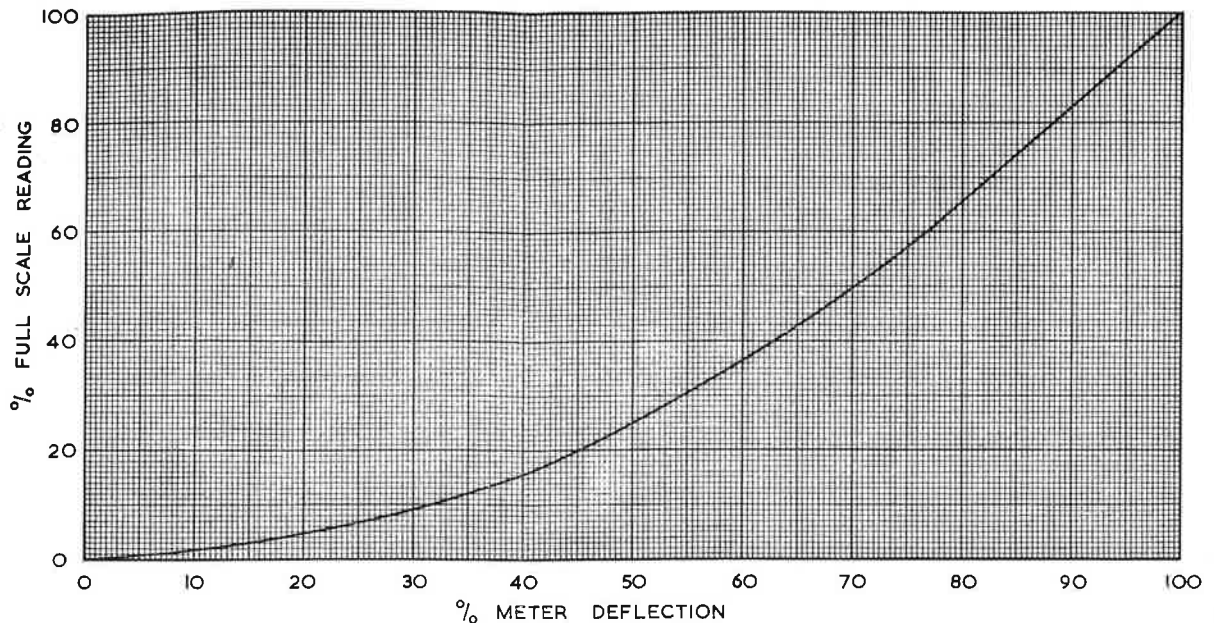

Calibration of the output meter scale.

### Construction

The way the instrument was put together will be readily seen from the photographs presented herewith. The four 1N34A diodes which form the meter rectifier were mounted on a small section of 289 matrix board with type 251 pins; two larger holes were drilled in the matrix board so that it could be fixed directly to the back of the meter using the meter terminals.

The nine preset tab potentiometers were mounted on a small section of bakelite board, which in turn was affixed to the inside of the back cover of the instrument. The ten leads to the potentiometers were laced together for convenience after the instrument assembly was completed.

### Calibration

After assembly of the instrument, it is necessary to adjust the preset potentiometers. This can be done by placing the METER switch in position 1 and then temporarily disconnecting the load resistors which are normally switched to input terminal 1. AC voltages (50 cps will do) are then applied to the input side 1 and the appropriate preset potentiometers adjusted at the various settings of the LOAD and RANGE switches for full scale deflection. The applied ac voltages should of course be those calculated

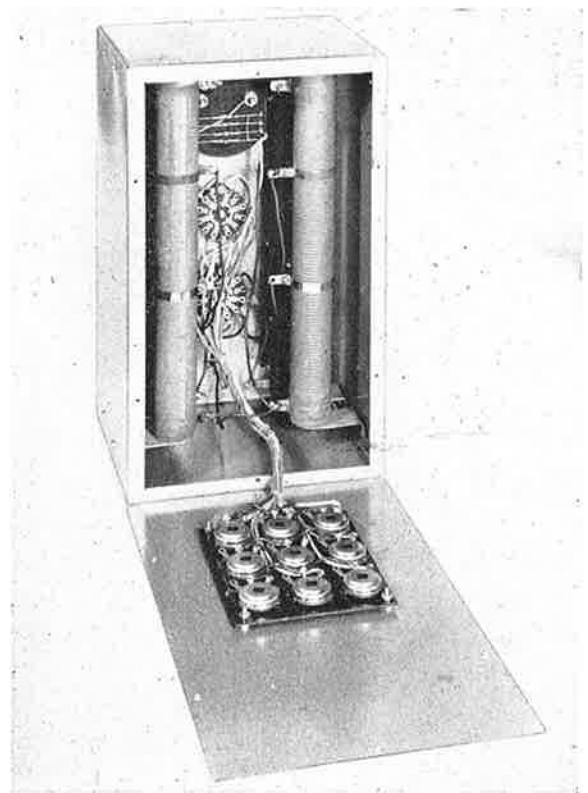

View of the internal arrangement of the output meter.

as described earlier in the article. Before starting the adjustments it may be wise to ensure that all the preset potentiometers are rotated to the maximum resistance position; this will avoid the possibility of accidental damage to the meter.

### Conclusion

This unit has already more than justified the small effort in making it. An instrument of this kind is essential to any serious experimenter interested in audio work, providing as it does in convenient form not only the dummy loads required, but a measurement of the power developed therein. Sufficient information has been given to enable readers to construct similar units using meters, loads and ranges of their own selection where these are different from those used in my instrument.

### Parts List

- 4 Germanium diodes, AWV type 1N34A.
- 1 Meter, moving coil, 0-2 ma f.s.d. (See NOTE below.)
- 4 Preset potentiometers, 5K ohms linear, type EC, TE or equivalent.

- 3 ditto, 10K ohms linear.
  - 2 ditto, 15K ohms linear.
  - 2 Resistors, 10 ohm, 100 watt wirewound, with adjustable taps at 4 and 8 ohms. Type HA, coating B, terminal type 2, with brackets, tolerance 5%, or equivalent.
  - 2 Resistors, 6 ohm, 100 watt wirewound, specification as above.
  - 2 M.S.P. "Oak" switches, "H" type AK19213, three-pole, three-way.
  - 1 Cutler Hammer toggle switch S.P.D.T.
- Miscellaneous: 3 terminals, 2 pointer knobs, bakelite board, metal case, assorted hardware.

### NOTE

Any suitable low-current meter may be used in this instrument, but if the full scale deflection is other than that of the instrument originally used, i.e., 0-2 ma, then the values of the nine preset potentiometers may have to be changed. The values should be recalculated as described in the text.



Editor ..... **Bernard J. Simpson**

*Radiotronics is published twelve times a year by the Wireless Press for Amalgamated Wireless Valve Co. Pty. Ltd. The annual subscription rate in Australasia is 10/-, in the U.S.A. and other dollar countries \$1.50, and in all other countries 12/6d.*

*Subscribers should promptly notify Radiotronics, Box 2516, G.P.O., Sydney, and also the local Post Office of any change of address, allowing one month for the change to become effective.*

*Copyright. All rights reserved. This magazine, or any part thereof, may not be reproduced in any form without the prior permission of the publishers.*

*Devices and arrangements shown or described herein may embody patents. Information is furnished without responsibility for its use and without prejudice to patent rights.*

*Information published herein concerning new releases is intended for information only, and present or future Australian availability is not implied.*