

RADIOTRONICS

VOL. 24, No. 3

MARCH, 1959

Price: One Shilling

**AMALGAMATED WIRELESS VALVE COMPANY
PTY. LTD.**

Registered at the G.P.O., Sydney, for transmission by post as a periodical

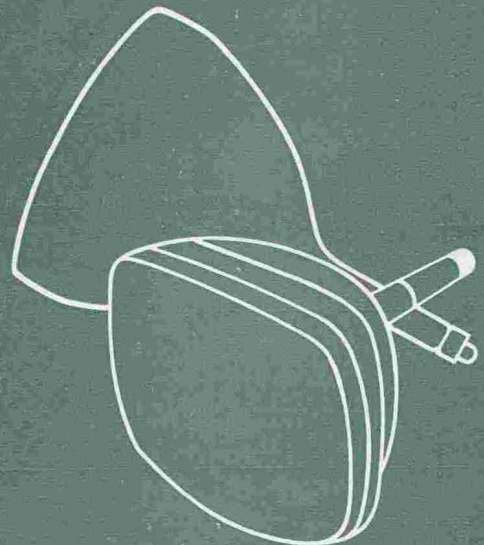

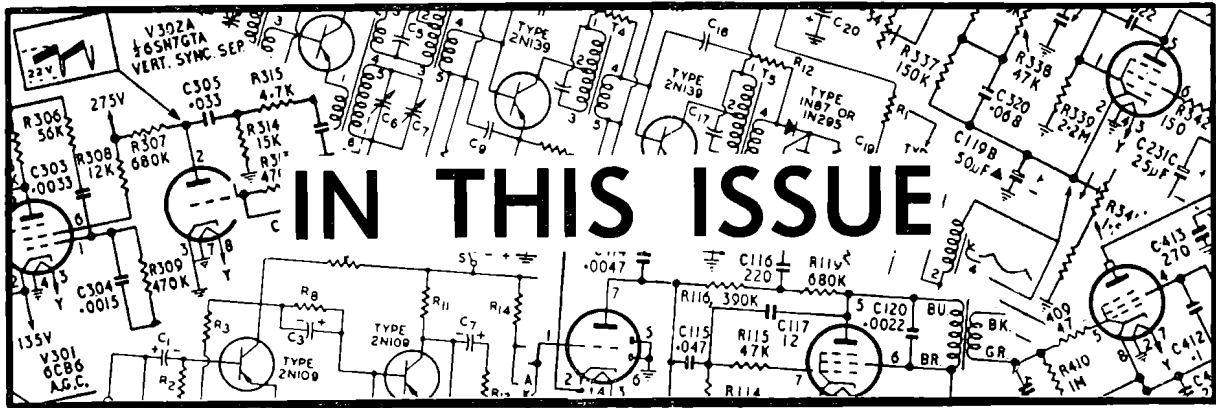

STEREO IN THE HOME

47

This is an article by an authority on the subject, Mr. H. F. Olson, of the RCA Princeton Laboratories. His article deals with the problems of creating realism in home reproduction, and the means available to achieve a performance reasonably comparable with the original performance.

SOME ASPECTS OF SYNCHRONIZATION IN TV RECEIVERS

52

Mr. J. van der Goot (AWV Application Laboratory) has covered in this impressive article a wide field. He deals first with vertical and horizontal oscillators, then a/c systems, and concludes with a comprehensive discussion of the inversion, amplification, limiting and clipping of the sync pulse.

TRANSISTOR FUNDAMENTALS — CHAPTER 2

58

This is the second and concluding chapter of our course on transistor fundamentals. As previously announced, this will be followed by a two-part article on Transistor Applications.

This month we are carrying on the work of bringing you interesting and "down-to-earth" articles in the field of electronics, in the enlarged 1959 volume of "Radiotronics". Among the articles now being prepared is a series on audio amplifiers, ranging from an ultra-linear 30 watt high fidelity unit to a 400 watt unit with 2% total harmonic distortion.

We have been bringing you lots of information on transistors in recent issues, and will continue to do so in the future. The reason is obvious — no one in electronics can afford to be "out of the picture" where semiconductors are concerned. The rapid growth of these units, in scope, quantity and performance, means that an extensive coverage is needed to bring readers up to date, and keep them up to date on transistors. The advent of the transistor, in its many shapes and forms, has been likened to the discovery of the thermionic valve. Whilst this may not be strictly true, it does perhaps convey some idea of the magnitude of the effect this device is having on the electronics industry.

Radiotronics is published twelve times a year by the Wireless Press for Amalgamated Wireless Valve Company Pty. Ltd. The annual subscription rate in Australasia is 10/-, in U.S.A. and dollar countries \$1.50, and in all other countries 12/6. Price of a single copy is 1/-.

Subscribers should promptly notify Amalgamated Wireless Valve Company Pty. Ltd., Box 2516, G.P.O., Sydney, and also the local Post Office of any change of address, allowing one month for the change to become effective.

Original articles in Radiotronics may be published without restrictions provided that due acknowledgement is given.

Devices and arrangements shown or described herein may use patents of AWV, RCA or others. Information is furnished without responsibility by AWV or RCA for its use and without prejudice to AWV's or RCA's patent rights. Information published herein concerning new RCA releases is intended for information only, and present or future Australian availability is not implied.

EDITOR BERNARD J. SIMPSON

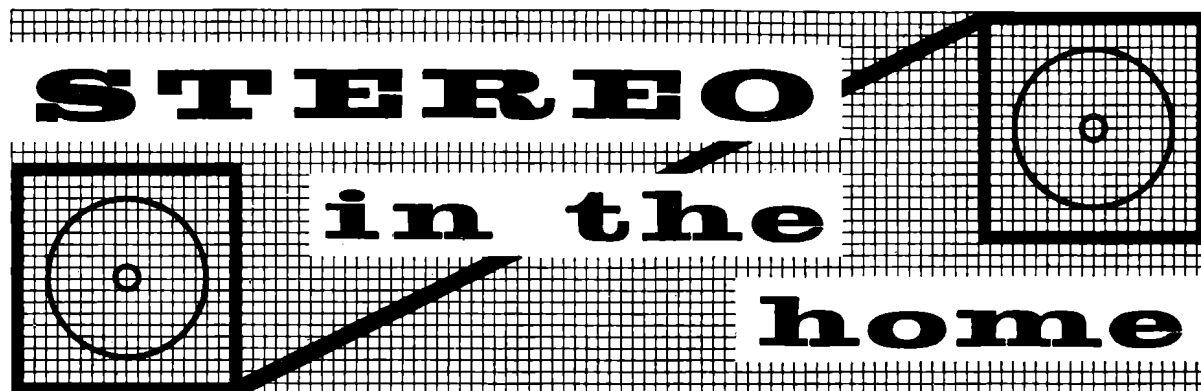

STEREO in the home

By HARRY F. OLSON

Realistic sound reproduction in the home implies solution of those problems which accompany spatial compression. The author draws upon his wide experience in this subject to describe the procedure and results of the psychoacoustical experiments designed to isolate the factors which contribute realism to sound reproduction in home-size listening rooms. He concludes that while true concert-hall acoustics cannot be simulated, the mechanical and electronic means to achieve a reasonable facsimile are available, and describes such a system for the playback of stereophonic magnetic tapes.

PART 1

INTRODUCTION

To achieve realism in a sound reproducing system three fundamental conditions must be satisfied, namely: first, the frequency range must be such as to include all the audible components of the various sounds to be reproduced; second, the volume range must be such as to permit noiseless and distortionless reproduction of the entire range of intensity associated with the sounds; third, the reverberation and spatial characteristic of the original sound must be preserved. During the past decade many experiments and tests have been conducted to determine the factors which play the major roles in establishing realism in reproduced sound under practical operating conditions in the home. It is the purpose of this paper to describe some of the fundamental experiments that have been carried out which have formed the basis for the systems and techniques which have been developed to pick up and record sound by stereophonic means in the studio and to reproduce the recorded sound by stereophonic means in the home.

ACOUSTIC FREQUENCY PREFERENCE TEST¹

In order to establish the validity of the first condition, namely, that the frequency range must be such as to include all the frequency components in the audio range, a fundamental all-acoustic

frequency preference test was conducted. The general arrangement of the test is shown in Fig. 1. An acoustical filter is placed between the orchestra and the listeners and is arranged so that it can be turned in or out of operation, as shown in Fig. 1. The response frequency characteristic of the acoustical filter approximates commercial radio or phonograph reproduction in the high frequency range. The acoustical filter is composed of ten units with each pivoted at the top and bottom. The ten units are coupled together and rotated by means of a lever. In this way, the acoustical filter can be placed in or out of operation by merely turning the units through 90°. The acoustical filters are shown in the full frequency range position in the plan view of Fig. 1. A sheer cloth curtain which transmits sound with no appreciable attenuation up to 10 Kc, and less than 2 db attenuation in the range from 10 Kc to 15 Kc is placed between the acoustical filter and the listeners. The curtain is illuminated so that the listeners cannot see what transpires behind the curtain. The particular condition, that is, the full frequency range or 5 Kc low-pass transmission, is shown on the A-B indicator.

The tests were conducted in a small room as shown in Fig. 1. This room simulates the average living room in dimensions and acoustics. The orchestra was a six-piece dance band playing popular music. The average sound level in the room was 70 db. The changes from wide open to low pass to wide open, etc., were made every 30 seconds. Two selections of popular music were played and the listeners were asked to indicate a

¹The all-acoustic frequency experiments were performed in 1946. A complete description of these experiments is reported by H. F. Olson, *J. Acoust. Soc. Amer.*, 19, 549 (1947).

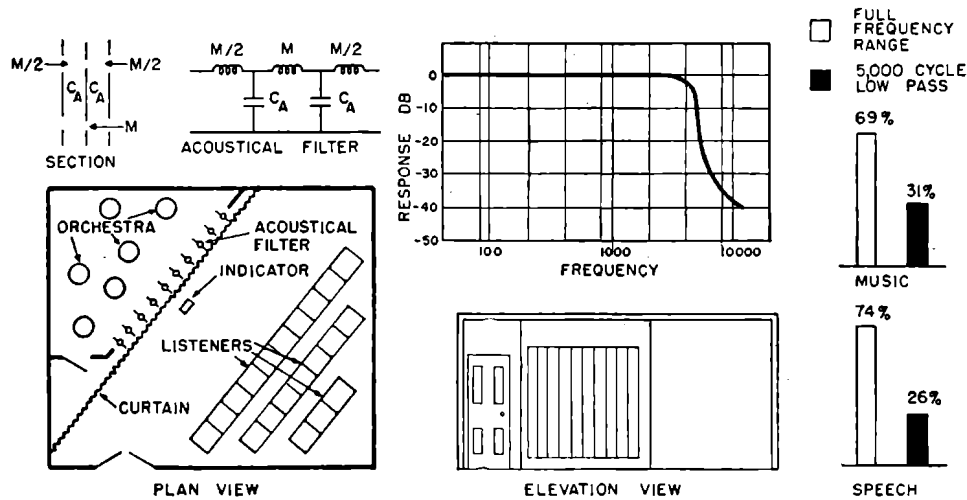

Fig. 1.—Plan and elevation views of the apparatus for the acoustic frequency preference testing of speech and music, including a sectional view, acoustical network, and the response frequency characteristic of the acoustical filter and the results for speech and music.

preference. The results of the tests have indicated a preference for the full frequency range. Similar tests have been made for speech. The preference for speech is also for the full frequency range. There is a distinct lack of presence in speech with limited frequency range.

The all-acoustic frequency preference test establishes the validity of the first condition, namely, that the frequency range must include all frequency components in the audio range.

NONLINEAR DISTORTION TEST²

In an ideal sound reproducing system the elements are invariant with respect to time. However, in a practical system all the elements are nonlinear. These nonlinear elements introduce nonlinear distortion. Some idea of the effect of nonlinear distortion can be obtained from a study of the masking curves³ of the ear. From these data it

will be seen that the higher-order harmonics are noticeable at much lower level than the lower-order harmonics. Furthermore, as the high-frequency range is increased the effects of the harmonics are more noticeable. In complex waves of speech and music, sum and difference tones are also an important phase of the problem of nonlinear distortion.

The subjective effect of the various types of nonlinear distortion of speech and music was determined by means of the system shown in Fig. 2. The overall response frequency characteristic of the microphone, amplifier, and loudspeaker was uniform to within 2 db from 45 to 15,000 cps

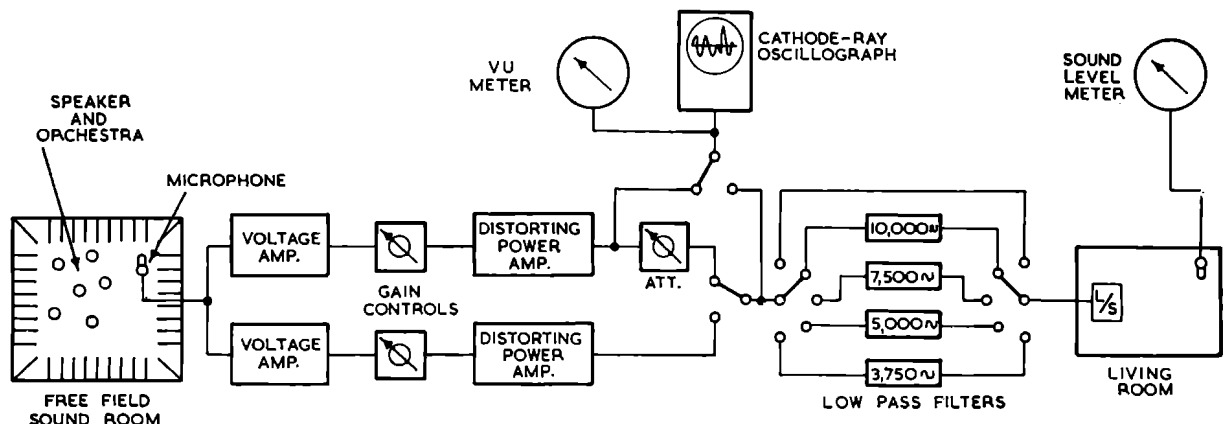

Fig. 2.—Schematic arrangement of the apparatus for a subjective determination of the relation between nonlinear distortion and frequency range preference in reproduced sound.

² The nonlinear distortion tests were performed in 1946. A description of the tests was first given in H. F. Olson, "Elements of Acoustical Engineering", (D. Van Nostrand Company, Princeton, N. J., 1947).
³ H. F. Olson, "Acoustical Engineering", (D. Van Nostrand Company, Princeton, N. J., 1957).

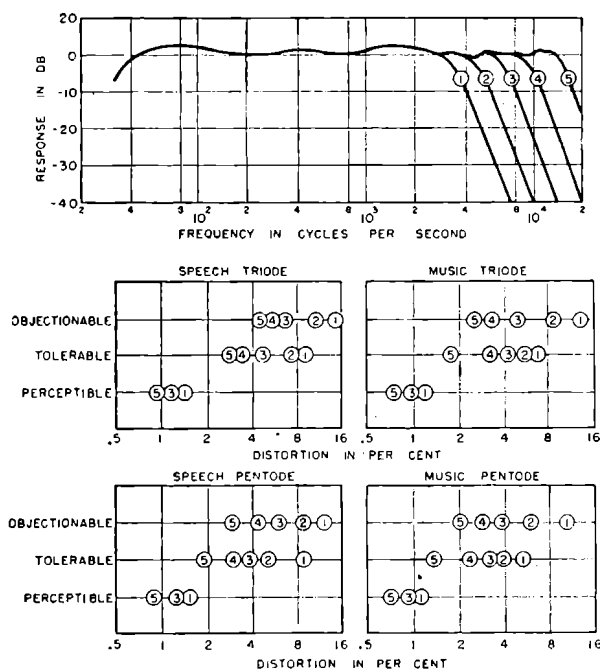

Fig. 3.—Experimental results of subjective tests of reproduced speech and music depicting objectionable, tolerable and perceptible nonlinear distortion for various high frequency cutoffs. The numbers in the distortion data correspond to the numbers which label the response frequency characteristic. The distortion in per cent is the ratio of the total rms of the second, third, fourth, etc., components of distortion to the rms of the fundamental, multiplied by one hundred.

(Fig. 3). Low pass filters were provided with cut-off frequencies at 3,750, 5,000, 7,500, and 10,000 cps. The nonlinear distortion in the overall channel was less than 0.25%. In addition, the distortion components were principally second and third harmonics. The pickup studio for these tests was the free-field room. The sound was reproduced in a room with dimensions and acoustics similar to that of the average living room. The noise level at the pickup point was from 0 to 10 db. The noise level in the listening room was about 25 db.

Two types of distorting amplifiers were used, a single-ended triode and a single-ended pentode. The distortion components for these two power output systems for various power levels are shown in Fig. 4.

These tests were limited to three subjective gradations of nonlinear distortion; perceptible, tolerable, and objectionable. Perceptible is the amount of distortion in the distorting system required to be just discernible when compared to the reference system. Tolerable and objectionable are not as definite and are a matter of opinion.

By tolerable distortion is meant the amount of

distortion which could be allowed in medium grade commercial sound reproduction. By objectionable distortion is meant the amount of distortion which would be definitely unsatisfactory for the reproduction of sound in phonograph and radio reproduction.

Both speech and music were used in making these tests. In the case of music a six-piece orchestra was employed.

The average results of a few of these tests, with a limited number of critical observers, are shown in Fig. 3. As would be expected from the frequency ranges of speech and music together with the masking curves, a distorting system with high-order harmonic components is more objectionable than one with low-order components. The amount of tolerable distortion is greater for speech than for music.

The objective and subjective tests on the determination of objectionable, tolerable and perceptible nonlinear distortion establish the following facts: (1) Sound reproducing systems with no perceptible nonlinear distortion can be designed and built provided considerable care is taken in the design and construction of the equipment, (2) Sound reproducing systems with tolerable nonlinear distortion can be designed and built employing conventional techniques in widespread commercial use today.

STEREOPHONIC FREQUENCY PREFERENCE TEST⁴

Two fundamental facts have been established in the preceding section, namely, the frequency range preference for live speech and music and the perceptible, tolerable and objectionable distortion in a sound reproducing system.

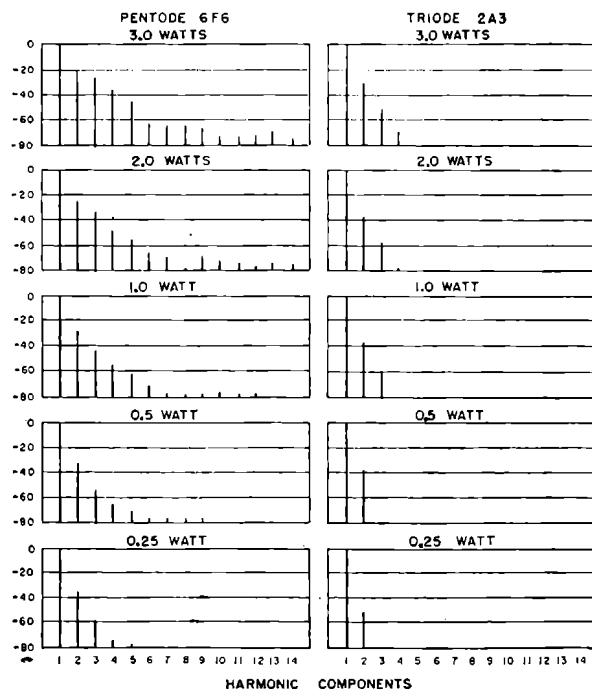

Fig. 4.—Distortion characteristics of single-ended pentode and triode amplifiers.

⁴The stereophonic frequency preference experiments were performed in 1948. A description of these experiments is given in H. F. Olson, "Acoustical Engineering", (D. Van Nostrand Company, Princeton, N. J., 1957).

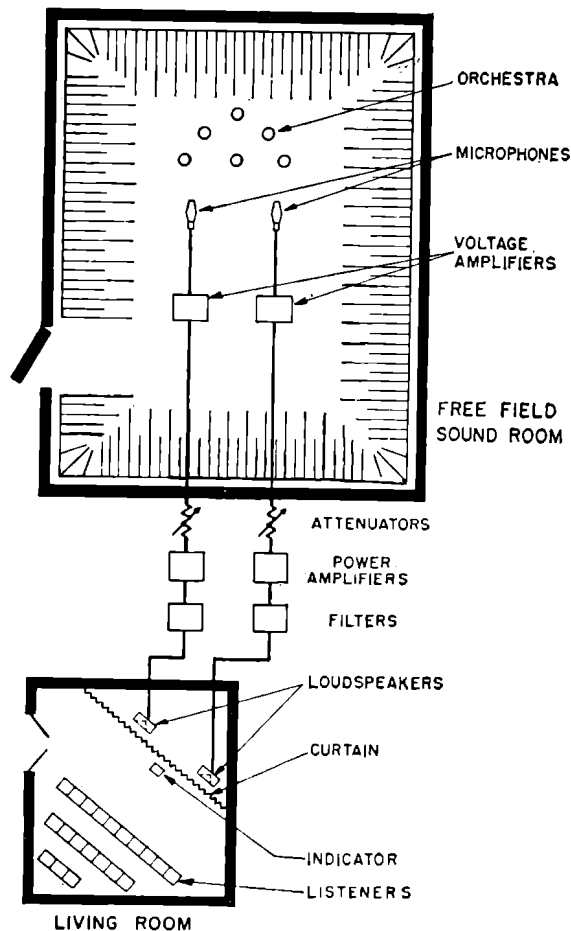

Fig. 5.—A schematic plan view of free-field room, the listening room, and the apparatus for the frequency range preference testing of stereophonic reproduced speech and music.

The next step is reproduction of the sound by stereophonic means with a system having low nonlinear distortion. Specifically, the problem is to "transfer" the reproduced orchestra to the position of the live orchestra by means of microphones, amplifiers and loudspeakers. The first step then becomes the elimination of the acoustics, i.e., the reverberation characteristics, of the pickup studio. This was accomplished by the use of a large free-field or anechoic room for the studio.

The floor plans of the free-field room used as a studio and of the listening room and the general arrangement of the tests are shown in Fig. 5. The idea of the test was to "transfer" the orchestra to the listening room by means of microphones, amplifiers, and loudspeakers. In order to simulate the all-acoustic tests in this transfer of the orchestra, it is obviously necessary that the studio be devoid of acoustics, that is, reverberation. To obtain these conditions the free-field room was used as the

⁵ Hanson, Rackey and Nixon, "Down to Earth on High Fidelity", Eng. Dept., NBC, New York, N. Y., March 27, 1944.

studio. With the orchestra playing in the free-field room, the level of the reflected sound at the microphone for steady state sound conditions is about 50 db below the direct sound. Therefore, it is impossible to detect any acoustics of the studio in the reproduced sound.

The listening room is the same as that used in the all-acoustic test, and, as noted before, was designed to be the acoustical equivalent of an average living room.

The reproducing system used in these tests employed two channels. Each channel consisted of an RCA 44BX velocity microphone, an RCA OP-6 amplifier, a laboratory-developed triode push-pull power amplifier, laboratory-developed high- and low-pass electrical filters, and an RCA LC1A loudspeaker.

The overall response frequency characteristics depicting the ratio of the sound pressure output from the loudspeaker in free space to the sound pressure at the microphone in free space, with and without the electrical filters, are shown in Fig. 6. In the restricted range condition there is attenuation in both the low- and high-frequency ranges. The product of the low- and high-cutoff frequency is 500,000 cps². This value has been recommended by many investigators⁵. In this test there is a deviation from the original all-acoustic frequency preference test in which a high-frequency cutoff alone was used. An argument in favor of the combination of high- and low-frequency cutoffs is that it approximates conventional radio and phonograph response frequency characteristics.

The directivity pattern of the loudspeakers is very important where the listeners are located at relatively large angles with respect to the loudspeaker. In the loudspeakers used in these tests the variation in response at any frequency over a total angle of 90° is less than ± 2 db.

The nonlinear distortion is another important factor in reproduced sound. The overall nonlinear distortion was measured by supplying a distortionless signal to the input of the chain consisting of

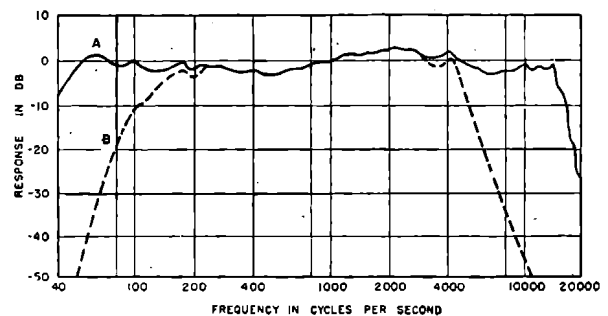

Fig. 6.—Over-all response frequency characteristic of the two frequency range conditions used in the frequency range preference tests for stereophonic reproduced speech and music. A. Wide frequency range. B. Restricted frequency range.

the voltage amplifier, power amplifier, and loudspeaker. The sound output of the loudspeaker was picked up by the microphone and fed to a harmonic analyzer. This method of measurement provides an overall distortion characteristic from sound input to the microphone to sound output of the loudspeaker. The total nonlinear distortion measured at the peak level of the reproduced sound was less than 0.3 per cent. From the results reported in the preceding section, it will be seen that this value of nonlinear distortion is sufficiently low to be practically imperceptible.

The level of the reproduced sound in the listening room is important in any subjective test. Tests have shown that a peak level of about 70 db to 80 db is most pleasing for serious listening in a small room. The average peak sound intensity level on a standard level indicator was 75 db.

The same six-piece band was used in these tests as in the case of the all-acoustic frequency range tests. The change from full frequency range to restricted frequency range was made every 30 seconds. The results of these tests indicate a preference for the full frequency range. Similar tests were made for speech, with the same result.

The stereophonic frequency preference tests demonstrate that a reproducing system with a low order of distortion and stereophonic sound reproduction yields the same results as the all-acoustic frequency preference test.

⁶ D. F. Seacord, *J. Acoust. Soc. Am.*, 12, 183 (1940).

NOISE TESTS

Noise usually determines the lower limit of reproduction in a sound reproducing system. In the sound reproducing system used in the "Non-linear Distortion Test" and the "Stereophonic Frequency Preference Test" there are two separate noise sources, namely, the ambient noise level in the free-field room and the listening room. The noise level in the free-field room was 0 to 10 db. The noise level in the listening room was 25 db. The noise level in the sound reproducing system as reproduced in the listening room was less than 10 db. Under these conditions the listening room was the limiting factor on noise. In this connection, it should be pointed out that the listening room was a relatively quiet room in view of the fact that the noise level⁶ in the average residence is 42 db.

The low order of noise in the reproducing system consisting of a microphone, amplifier, and loudspeaker used in these experiments cannot be achieved when a record is used for the reproduction of the sound. However, subjective tests of high grade commercial disc and magnetic tape records and reproducers have shown that the noise in these reproducing systems is of no practical consequence when the sound is reproduced under the noise level conditions of the average residence.

This article, which will be concluded next month, is reprinted from the *Journal of the Audio Engineering Society*, by kind permission of the Society.

EDITOR'S NOTE

Whilst this article is specifically related to the reproduction of pre-recorded stereo tapes, all the general remarks and arguments apply equally well of course to the reproduction of stereo disc recordings.



COMING . . . FOR THE AUDIO ENTHUSIAST . . .

FOUR ULTRA-LINEAR AMPLIFIERS WITH 30

50, 100 AND 400 WATT RATINGS

A 150-WATT CLASS-B AMPLIFIER

Some Aspects of Synchronization in TV Receivers

By J. VAN DER GOOT, M.I.R.E. (Aust.)

PART I

VERTICAL OSCILLATORS

Summary

This article discusses some aspects of synchronization encountered in Australian television receivers. Different types of scanning oscillator—and afc systems are described. The requirements for synchronizing the oscillators and subsequently the circuitry to satisfy these requirements are discussed. Several factors affecting the quality of the picture are treated in more detail. The article concludes with a description of a simple sync circuit which embodies the principles discussed.

Introduction

This article discusses some aspects of synchronization of the scanning oscillators in television receivers. For this purpose descriptions are given of the most commonly used scanning oscillators and the circuitry necessary to obtain synchronous operation of these oscillators from the composite video information as it appears at the video end of a receiver.

The main functions which will be discussed are as follows:

- (a) Vertical oscillators.
- (b) Horizontal oscillators and afc systems.
- (c) Sync pulse inverting, amplification, and limiting.
- (d) Sync pulse clipping.

Before discussing the requirements for synchronization a survey of the most commonly used scanning oscillators and the manner in which they operate is necessary.

Scanning oscillators are needed for two functions:

(a) **The Frame—or Vertical Oscillator.** In a 2 to 1 interlaced scanning system such as used in the Australian system the vertical oscillator scans twice for one complete picture. There are 25 of these pictures per second. So the vertical oscillator must operate at a frequency of 50 cps.

(b) **The Line—or Horizontal Oscillator.** There are 625 lines per picture in the Australian system. So the horizontal oscillator must operate at a frequency of 15,625 cps (625×25).

Both oscillators in the receiver must operate in synchronism with the oscillators at the transmitter. Therefore the transmitter transmits sync pulses as part of the composite video signal. The vertical pulse train, also referred to as the "sync block" consists of 5 pulses each of approximately 27 μsec duration and separated by approximately 5 μsec . The horizontal pulses are single pulses of approximately 5 μsec duration.

There are two types of oscillators commonly used for vertical—and horizontal scanning:

- (1) The blocking oscillator.
- (2) The multivibrator.

The circuitry around the scanning oscillators may vary from one receiver design to another but they are all fundamentally of either the blocking oscillator or multivibrator type.

Vertical Oscillators

Vertical oscillators are usually directly synchronized. This means that the oscillator is triggered by a pulse which is shaped from the vertical sync block after the latter has been separated from the composite video signal. Thus the oscillator is forced to keep in step with the transmitted vertical pulses.

One type of vertical oscillator is discussed here.

The Vertical Blocking Oscillator

Fig. 1 (a) shows a simplified circuit diagram of a blocking oscillator. TR is a transformer which is connected with such a polarity that when the cathode current increases the voltage at g becomes more positive. When voltages are first applied to the valve V the increasing cathode current will make g positive with respect to the cathode, grid current will flow, and C1 will be charged with a polarity as indicated in Fig. 1 (a). The sudden rise of current through TR will result in an emf which charges TR's self capacitance, Cs. For simplicity's sake Cs is assumed to be across the grid winding only. When the charge on C1 increases the grid current will decrease and for a short period the algebraic sum of the charging current of C1 and the discharge current of Cs will provide a rate of change of current in TR of approximately zero. This is the nearly flat, horizontal portion indicated in Fig. 1 (b).

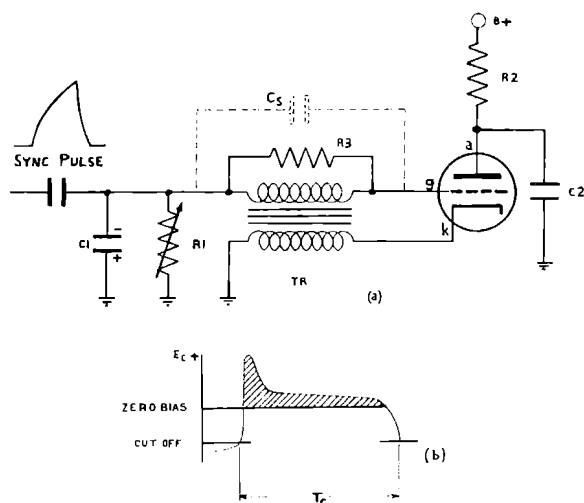

Figure 1.—(a) Circuit diagram of vertical blocking oscillator. (b) Grid voltage waveform during conduction.

When the charge on C1 increases further still the discharge current of Cs will become relatively larger. This rate of change will be amplified by the positive feedback of V and TR. The grid potential will swing to a negative value which is the algebraic sum of the potential across C1 and the instantaneous emf of TR. TR and R3 are chosen so that TR's self-oscillation is heavily damped. The next positive swing does not raise the potential of g past the plate current cut-off potential and the result is that the time in which the cut-off potential is reached is almost completely determined by the discharge time constant of C1 and R1. Fig. 2 shows simplified grid voltage waveforms for a vertical blocking oscillator. When the plate current cut-off potential is reached V starts to draw plate—and cathode current and because

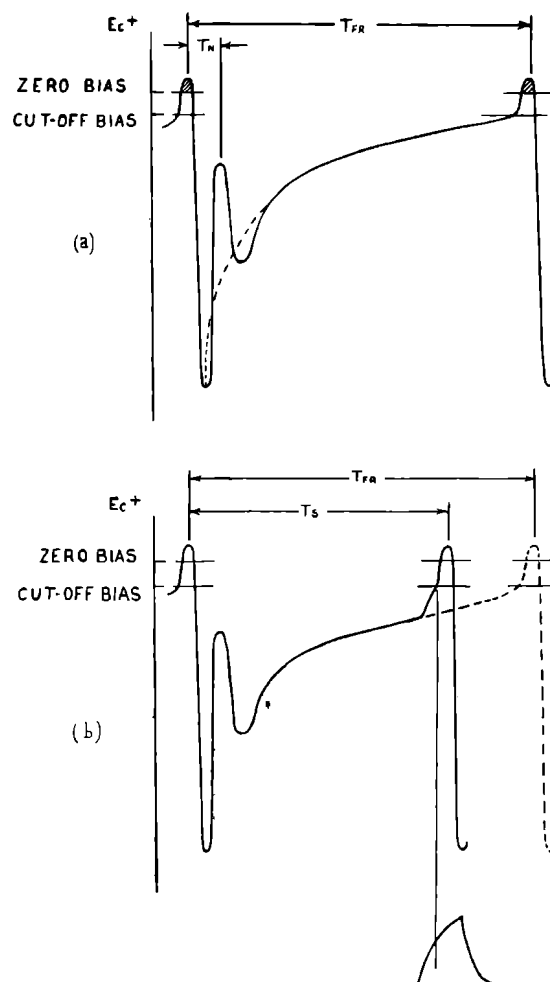

Fig. 2.—Grid voltage waveform.
(a) Free running.
(b) Synchronized.

of the positive feedback by means of TR the cycle is repeated again. Fig. 1 (b) is actually an expanded view of the hatched portion of Fig. 2 (a). During the time that the plate current of V is cut off, C2 is charged from the B+ supply by R2. During the time that V is conducting C2 is discharged and the plate voltage of V falls rapidly.

The free running frequency of the blocking oscillator can be varied by making R1 variable. The conduction period T_c is mainly determined by the operating characteristics of V, the values of C1 and C2, and the characteristics of TR. This conduction period is of importance with regard to interlace as will be seen later when discussing the significance of the post-equalizing pulses. If positive going sync pulses are applied in the manner indicated in Fig. 1 (a) and the free running period of the oscillator is T_{fr} (Figs. 2 (a) and (b)) the oscillator will be triggered every time a sync pulse is applied. The oscillator is then synchronized with the transmitter.

A vertical multivibrator can be synchronized in a manner similar to that for the blocking oscillator.

Vertical Sync Pulse Amplitude

The amplitude of the sync pulses required to synchronize the vertical oscillator depends on the amplitude of the grid voltage swing of the oscillator itself. Fig. 3 explains this. In Fig. 3 (a) three curves have been drawn showing how the grid voltage rises exponentially until the plate current cut-off grid voltage is reached. The free running period T_{fr} is the same for the three cases. When synchronized the period is T_s . Fig. 3 (b) shows on a larger scale the intersection of the three curves and the vertical at T_s . It shows that for a given, free running, period T_{fr} , the voltage, E_s required to drive the grid past plate current cut-off increases as the grid voltage amplitude, E , increases. In other words: the larger the grid voltage swing of the oscillator, the larger the sync pulse amplitude required to synchronize the oscillator.

For a given degree of feedback the grid voltage swing depends on the required oscillator output voltage swing. The oscillator output voltage swing is in turn determined by the output valve which is driven by the oscillator. Naturally a triode requires a larger driving voltage than a pentode. A discussion of the relative advantages and disadvantages of triode—and pentode output valves is beyond the scope of this article.

In general it can be stated that with an oscillator valve of average gm (3000 — 4000 μ mhos) the required vertical pulse amplitude is of the order of 2.5 — 3.0 volts for a pentode, and 8 — 10 volts for a triode output valve.

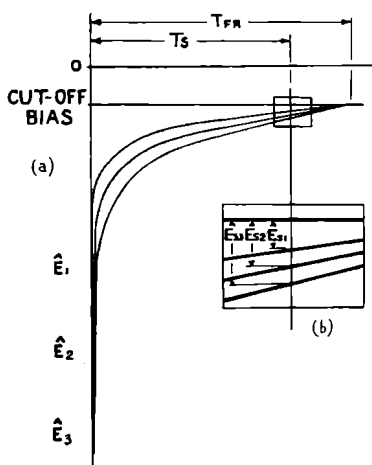

Figure 3.— (a) Diagram showing three curves representing exponentially rising grid voltages with different initial amplitudes. (b) Intersections of the three curves of (a) with the vertical at T_s ; on a larger scale.

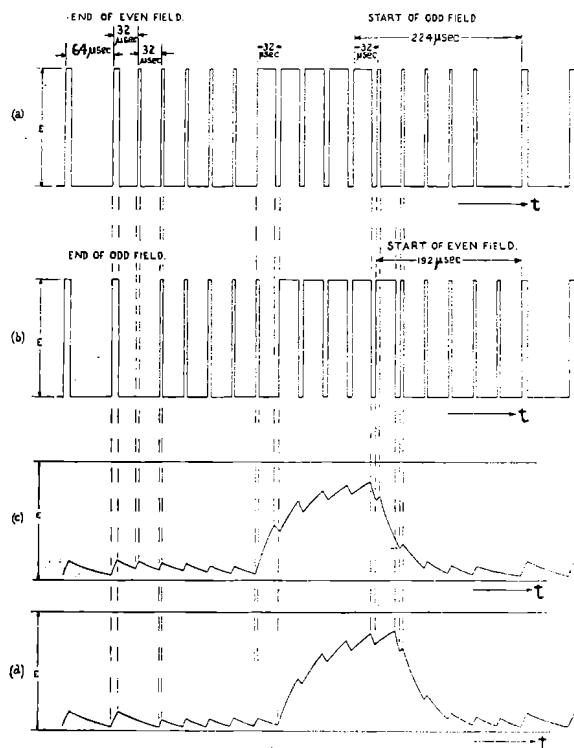

Fig. 4.—Part of a field of sync pulses showing equalizing pulses and vertical sync block.

- (a) Even field.
- (b) Odd field.
- (c) Integrated waveform of (a).
- (d) Integrated waveform of (b).

Integration

Figs. 4 (a) and (b) represent the end of a field of horizontal sync pulses, the pre-equalizing pulse train, the vertical sync block, the post-equalizing pulse train and the start of the following field of horizontal sync pulses. These are the waveforms after the video information has been removed from the composite video waveform. The sync information of Figs. 4 (a) and (b) can be applied to an integrating network of the simplest RC form which may have a time constant of 30 to 50 μ sec. Fig. 4 (c) shows the voltage across C resulting from the waveform of Fig. 4 (a); Fig. 4 (d) shows the voltage resulting from that of Fig. 4 (b). Figs. 5 (a) and (b) show the two integrated pulses of Fig. 4 (c) and (d) with reference levels. The voltage levels refer to an integrating time constant of 50 μ sec. Figs. 5 (c) and (d) show the two integrated pulses that would result if there was no equalizing pulses (see Appendix). Note in Figs. 5 (a) and (b) that the voltage at the start of the first vertical sync pulse is 0.0671 E for odd fields and 0.0654 E for even fields. If there were no pre-equalizing pulses these voltages would be 0.0891 E and 0.0470 E respectively,

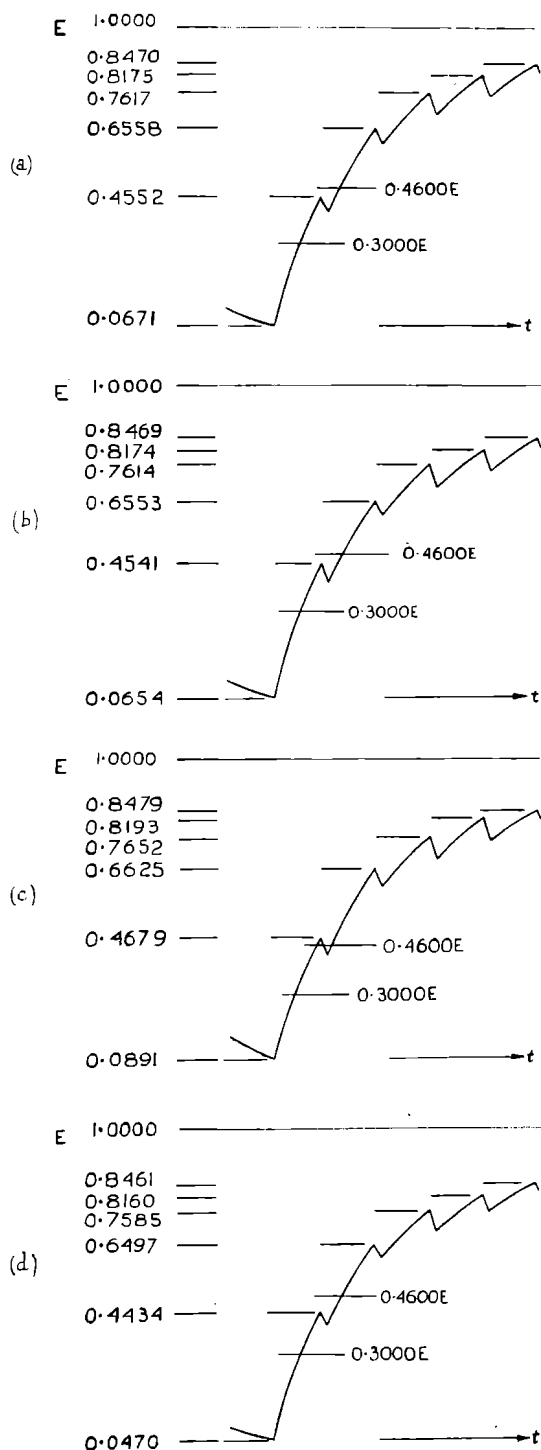

Figure 5.—Integrated vertical sync block (see Appendix).

- (a) and (b) when pre-equalizing pulses are present.
 (c) and (d) when no pre-equalizing pulses are present.
 (a) and (c) end of even fields.
 (b) and (d) end of odd fields.

Figs. 5 (c) and (d). The time interval between the leading edge of the last horizontal pulse and the leading edge of the first vertical pulse would be half a line duration at the end of odd fields and a full line duration at the end of even fields.

The time interval between the start of the vertical sync blocks of two successive fields is maintained at exactly 312.5 lines by the transmitter. For perfect interlace the time interval between the leading edge of the first vertical sync pulse and the instant the vertical oscillator of the receiver is triggered should therefore be constant for odd—and even fields. In other words the time interval between the start of the integrated vertical sync pulse and the point where the triggering level of the grid potential of the vertical oscillator is reached should not vary from odd to even fields. If the difference in the time intervals is half a line duration (32 μ sec) complete pairing results. The condition of interlace can be expressed as a percentage. If the difference in triggering time intervals is α μ sec the percentage interlace is $[(32 - \alpha)/32] 100\%$. 50% (16 μ sec) interlace results in bad pairing; 75% (8 μ sec) interlace results in noticeable pairing; 87—100% (4—0 μ sec) interlace is considered to be good¹.

Let us assume a hypothetical case in which the interlace condition is only determined by the instant the integrated pulse reaches the triggering level. In practice interlace is affected by several factors which are described later. If the instant of triggering coincides with a pulse level of 0.3 E (Fig. 5), the percentage interlace with pre-equalizing pulses is 99.7. In the case without pre-equalizing pulses the percentage interlace is 93.1. However, if the pulse level at the instant of triggering is 0.46 E (Fig. 5), the percentages interlace are 99.4 with—and 65.5 without—pre-equalizing pulses respectively. These examples illustrate clearly how the interlace condition changes with triggering level (setting of the hold control) in the case without pre-equalizing pulses.

The manner in which the voltage levels and times were derived is described in the appendix.

The Significance of the Post-equalizing Pulses²

Looking at Fig. 1 (b) again any horizontal sync pulse that occurs at the approximate time the grid potential starts to fall will affect the conduction time of the vertical oscillator valve, Fig. 6.

1. "Some aspects of synchronizing for Australian television receivers", A.R.T.S. and P. Bull. No. 2, 15 Nov., 1957.
2. Burns, W. W., "The purpose of the post-equalizing pulses in the television composite video signal", *Radiotronics*, 22, June, 1957.

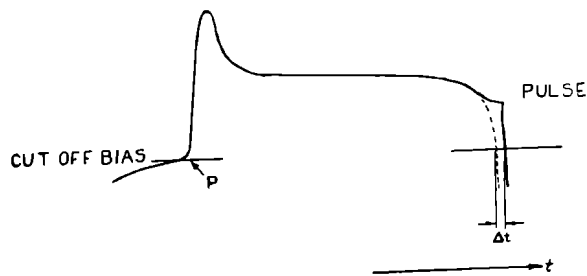
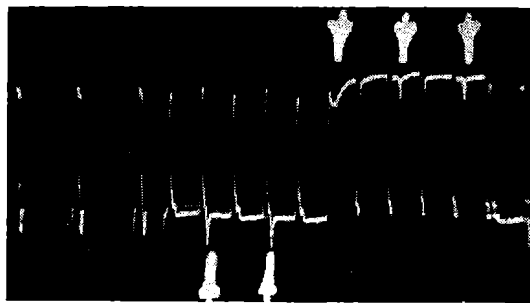
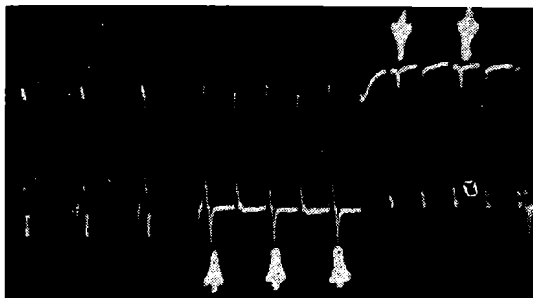

Figure 6.—Grid voltage waveform during conduction with horizontal pulse.

When a sync pulse is present the conduction time will be δt longer than it would be without that pulse. The vertical scan starts almost immediately after the oscillator valve has ceased conducting. Horizontal sync pulses occur at different times during the conduction time in odd—and even fields. Therefore when horizontal sync pulses are present on the conduction waveform the vertical scan does not start at intervals of exactly 312.5 lines. Thus interlace will be destroyed. However, with a train of post-equalizing pulses the occurrence of pulses during conduction will be similar



(a)



(b)

Figure 7.—Oscillograms of part of a field of sync pulses in the composite video waveform showing feedback pulses (indicated by arrows).

(a) End of even field.

(b) End of odd field.

Sweep: 50 $\mu\text{sec}/\text{cm}$. Sweep length in all oscillograms is approximately 10 cm.

in odd—and even fields so long as the conduction has ceased before the first horizontal sync pulse arrives. Thus good interlace can be maintained. The time at which the first horizontal pulse after the post-equalizing pulse train occurs sets an upper limit for the vertical oscillator conduction time.

For instance if the vertical oscillator is triggered at the instant the leading edge of the last (5th) vertical pulse occurs, the time interval between the instant of triggering (point P in Fig. 6) and the first horizontal sync pulse is 224 μsec ($5 \times 32 + 64$) for the odd fields and 192 μsec ($5 \times 32 + 32$) for the even fields (Figs. 4 (a) and (b)). This implies that the maximum permissible conduction time is 192 μsec . In practice the conduction time is made equal to or smaller than 160 μsec .

From the previous discussion it is clear that the pre- and post-equalizing pulses help to produce good interlace. However, the equalizing pulses lose their effectiveness if feedback pulses from the horizontal oscillator or output circuits are introduced into the sync circuitry. Pulses of this kind can easily be introduced by capacitive coupling particularly due to the large amplitude of the fly-back pulses in the horizontal output circuit. Methods for reduction of this feedback will be discussed in the next section. Fig. 7 (a) and (b) show oscillograms of part of a field of sync pulses with rather large horizontal feedback pulses. Note the shape of the feedback pulses due to the differentiating effect of the capacitive coupling. At the end of the even field the horizontal feedback pulses coincide approximately with the 2nd and 4th pre-equalizing pulses and the leading edges of the 1st, 3rd and 5th vertical sync pulses. At the end of the odd field the feedback pulses coincide approximately with the 1st, 3rd and 5th pre-equalizing pulses and the leading edges of the 2nd and 4th vertical pulses. A situation results which can approach the condition existing with no equalizing pulses. In addition the feedback pulses in the vertical sync block will vary the shape of the integrated vertical pulses from odd to even fields (Figs. 8 (a) and (b)). Naturally this will make the interlace condition worse still.

Horizontal Feedback Pulses.

As was explained in the previous section horizontal feedback pulses introduced into the sync circuitry may destroy interlace. One of the causes of feedback pulses encountered in practice is capacitive coupling between the lead to the picture tube control electrode (this is the cathode with a positive going video signal) and the horizontal yoke leads. Particularly when the sync is taken from the plate of the video amplifier the amplitude of the horizontal feedback pulses can

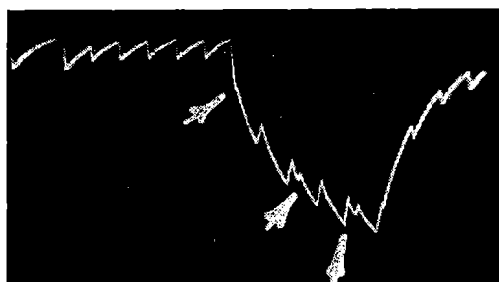

(a)

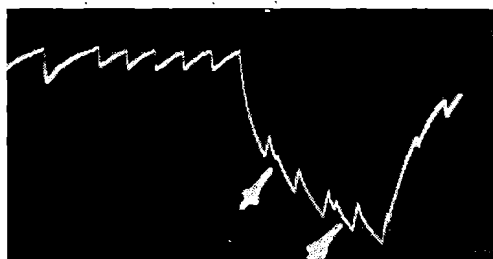

(b)

Figure 8.—Oscillograms of integrated vertical pulses with feedback pulses.

(a) End of even field.

(b) End of odd field.

Sweep: 50 μ sec/cm.

be quite high as shown in Figs. 7 (a) and (b). After sync clipping the relative amplitude of these pulses may become even greater. This type of coupling can be reduced by keeping the tube lead away from the yoke leads. This also agrees with the requirement of low capacitance of the tube cathode lead to ground to reduce high frequency shunting of the video amplifier load. The chassis lay-out should be such that the video amplifier circuitry is kept away from horizontal output components and associated leads.

Another source of feedback pulses is capacitive coupling from the vertical output valve back to the grid of the vertical oscillator. Where long

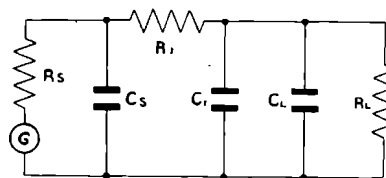

Figure 9.—Equivalent circuit diagram of an integrating network with valves connected to the input and output.

vertical, and horizontal yoke leads run in parallel, horizontal pulses of considerable amplitude can be introduced in the vertical output circuit. Plate-to-grid capacitance of the vertical output — and oscillator valves will couple these pulses back into the grid circuit of the oscillator. The use of a pentode vertical output valve will reduce this type of coupling. However, in circuits where a triode is used feedback of the horizontal fly-back pulses can be adequately reduced by maintaining a low impedance (at the horizontal frequency) between the plate circuit of the vertical oscillator and ground.

Impedance Considerations

Fig. 9 shows the equivalent circuit diagrams of an integrating network with signal source and load. The source impedance is not very critical. In practice the source is usually a valve the output reactance of which is capacitive. The only effect the source impedance will have is a slight integrating effect which is of no practical consequence. In practice the load is also a valve the input reactance of which will be capacitive. The effective load capacitance acts in parallel with the integrator capacitor C_1 . In general C_L will be small compared with C_1 . However, the effective load resistance R_L and R_1 form a potential divider and for maximum output R_L should therefore be large compared with R_1 .

This article, which will be continued next month, is reprinted from the Proceedings of the Institution of Radio Engineers (Aust.), by kind permission of the Institution.

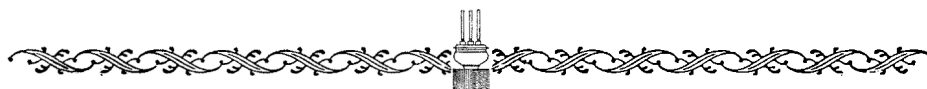

TRANSISTOR FUNDAMENTALS

CHAPTER TWO

THE P-N-P AND N-P-N JUNCTION TRANSISTOR

Although there are many variations of a junction transistor, we can easily understand their operation if we consider them being assembled as a sandwich. The outside layers are relatively thick as compared to the very thin centre layer. The important fact being that the semiconductor material is used alternately, such as n-p-n or p-n-p. These types are represented by the illustrations in Figure 15. The leads are identified as the emitter, collector and base.

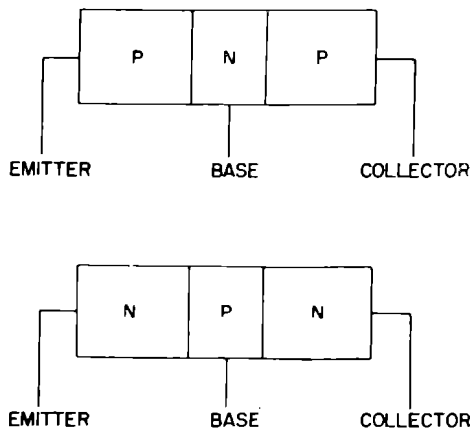

FIGURE 15

N-P-N Transistor Action

The transistor illustrated in Figure 16 is of the n-p-n type. It is impossible for either holes or electrons to overcome the potential barriers formed at the two junctions. Consequently, no current flow is possible without the application of an external voltage source.

Now let us take the n-p-n transistor and connect the external voltage sources as illustrated in Figure 17. After studying the p-n junction we know that battery A connected as shown,

will in effect, reduce the potential barrier between the emitter and base regions. Also, we know that battery B, connected as shown, will in effect increase the potential barrier between the base and collector regions. This battery arrangement will permit electrons to flow from the emitter into the base region. But because the base region is so very thin, most of the electrons will not combine with the holes in this region but will pass into the collector region. This electron passage is possible due to the fact that voltage source B, connected across the second p-n junction, is of such polarity that it favours the entrance of electrons from the base to the collector. Once in the collector (n-region), the electrons are attracted to the positive collector electrode, thereby completing their passage through the transistor.

Now let's see what takes place when an ac signal is applied to the emitter as shown in Figure 18. When the signal swings positive, the potential barrier increases, thereby reducing electron flow through the emitter. When the negative half cycle of the signal is present at the emitter it tends to reduce the potential barrier, increasing electron flow through the emitter. Again because the base region is so very thin most electrons will pass through without combining with the holes and find entrance to the collector.

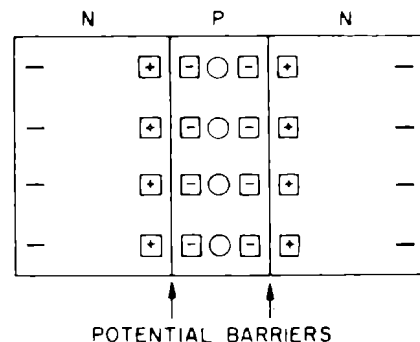

FIGURE 16

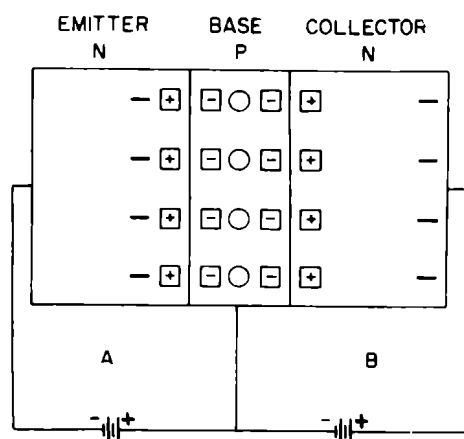

FIGURE 17

P-N-P Transistor Action

A junction transistor of the p-n-p type is illustrated in Figure 19. It consists of p and n semiconductors used alternately. In order to have conduction in such a transistor, it is necessary that the battery polarity to the emitter and collector be opposite to that used by the n-p-n transistor. With this connection the holes in the emitter region are repelled by the positive potential of the battery toward the p-n junction. Since this reduces the potential barrier existing between the emitter and base, the majority of the holes pass through the relatively thin base area (n-region) into the collector region. A small number of holes are lost by combination with electrons in the base region. As each of the remaining holes enters the collector it is filled by an electron emitted by the negative terminal of the battery.

For each hole lost by combination within the base or collector region, an electron from one of the covalent bonds near the emitter electrode enters the positive terminal of the battery, resulting in the formation of a new hole. The new

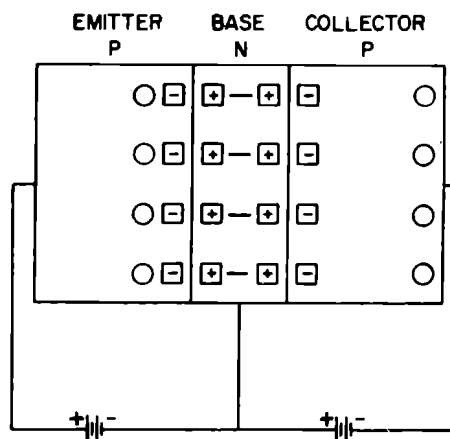

FIGURE 19

hole moves toward the junction area, thus maintaining a continuous flow of holes from emitter to collector.

Amplification in a Junction Transistor

Further investigation of conduction in a junction transistor will show that the emitter current is greater than the collector current. For example, let us consider a case where 1 ma of current flows in the emitter circuit as illustrated in Figure 20. The base current under this condition will be proportional to the number of hole and electron combinations that take place in the base region; also, this base current will be affected by the amount of voltage applied between the base and collector. Under normal operating conditions the voltages are adjusted so that 5% of the total emitter current will flow in the base circuit, the remaining 95% of the emitter current flows in the collector circuit. From this it can be seen that the collector current will be less than unity as compared to the emitter current. The chart in Figure 21 shows the relationship between the

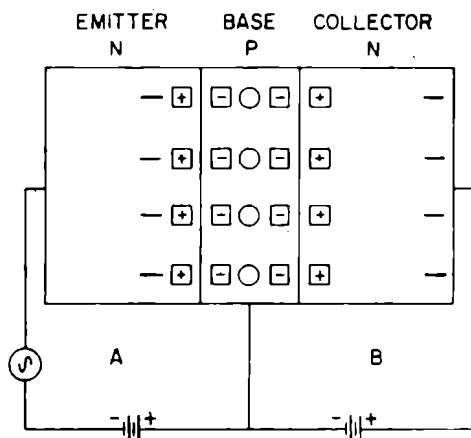

FIGURE 18

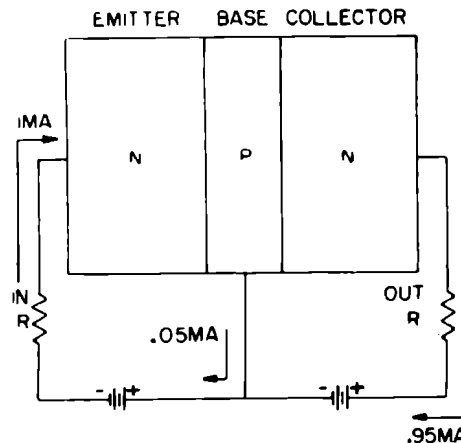

FIGURE 20

collector voltage and current. As indicated by letter A, there will be no flow of current in the collector circuit when the collector voltage is zero. As we increase the collector voltage the collector current will increase linearly until a point of saturation is reached as indicated by the letter B in Figure 21. If we further increase the collector voltage the collector current will remain nearly constant. This response curve is very similar to that of the I_p, E_p curve of a pentode valve. Thus, it can be seen that current flow within the collector region is independent of the collector voltage after the point of current saturation has been reached. Therefore, it is desirable to operate the collector circuit at a voltage indicated by the letter C in Figure 21.

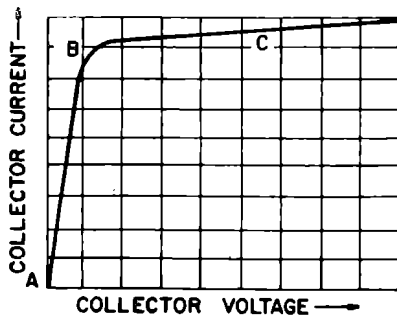

FIGURE 21

In order to understand how amplification can take place within a transistor, we must investigate the input and output resistance characteristics of the junction transistor. The battery in Figure 20 is connected between the emitter and base with its polarity such that the potential barrier between the emitter and base is greatly reduced. Current readily flows through this junction, thereby reducing the input resistance to the emitter.

The battery connected between the collector and base is of such polarity that the potential barrier between the base and collector is greatly increased. Thus, the output resistance of the collector circuit is very high. Since we have a low input resistance and a high output resistance, voltage amplification can be effected by a junction transistor. Due to this resistance difference, a small voltage change in the emitter circuit will cause a relatively large voltage change in the collector output circuit. This is due to the fact that a small voltage change at the input will cause a large current change within the emitter. The current change in the collector circuit is directly proportional to the current change in the emitter circuit. Since the output resistance of the collector circuit is relatively high, a change in collector current will produce a relatively large voltage change across this output resistance. This action can be closely related to a pentode

valve circuit, where small grid voltage changes produce relatively large plate voltage changes. From the foregoing it can be seen that if we apply a small ac signal to the input of the transistor, this signal will be amplified in the collector circuit.

Another factor must be taken into consideration. That is, the peak to peak voltage swing at the input of the transistor must not exceed the battery potential connected between the emitter and base; also the peak to peak voltage swing in the collector circuit must not exceed the battery potential between the collector and base. If the ac swing should exceed either of these battery potentials, the signal will be greatly distorted.

Both n-p-n and p-n-p type transistors may be used as amplifiers. The only basic difference is that the battery potentials are reversed when comparing these two types of transistors in their circuit applications. The applications of these transistors will be discussed later.

THE POINT CONTACT TRANSISTOR

The point contact transistor is the result of early experimentation with the germanium crystal. The construction of the point contact transistor is illustrated in Figure 22. It consists of a piece of n-type semiconductor to which are attached leads known as the emitter, base and collector. An important fact in the construction of the point contact transistor is the method in which the leads are attached to the piece of semiconductor material. The base lead as illustrated in Figure 23 is a low resistance connection, whereas the emitter and collector leads make contact by the sharp pointed ends of the leads. The emitter and collector leads are high resistance connections.

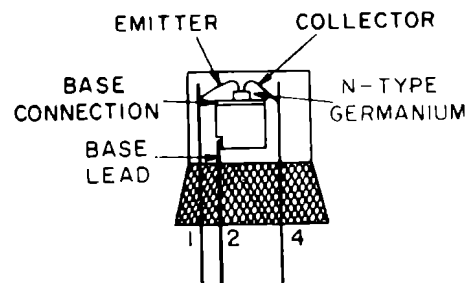

FIGURE 22

To understand transistor action in the point contact transistor let us begin by analyzing the emitter portion as illustrated in Figure 24. We learned from a previous section that n-type semiconductor material has an excess of free electrons, and by the application of a potential across the semiconductor, electrons will flow through the semiconductor to complete the circuit. Figure 24 (a) illustrates a negative potential applied to

the emitter and a positive potential applied to the base. Under these conditions electron flow will take place.

Let us change the polarity of the supply battery so that the emitter contact is now positive and the base is negative as illustrated in Figure 24 (b). Now the **positive** potential is applied to a small point, rather than being distributed evenly along the entire base area as in Figure 24 (a). The emitter now being positive in polarity results in the attraction of free electrons from the n-type semiconductor. Thus, electron flow takes place. However, because of the **intense concentration of energy** in the vicinity of the emitter, it not only attracts the free electrons present in the semiconductor but also withdraws valence electrons from the covalent bond structure in the immediate area. This action of removing valence electrons results in the formation of holes. These holes diffuse toward the base which discharges additional electrons to fill them with the result of **increased electron flow**. It can then be seen that as long as the emitter is negative in polarity there is relatively little electron flow. However, if the emitter is made positive there is the formation of holes due to the **concentration of energy** present at the point contact, which results in an **increase of electron flow**. Rectification, therefore, is possible.

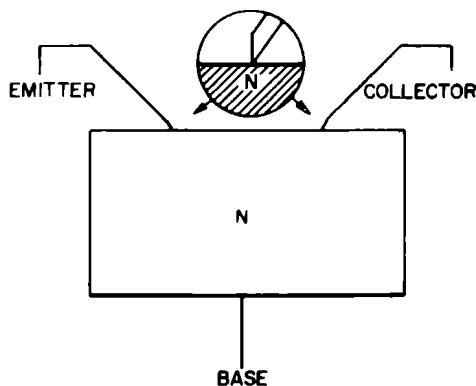

FIGURE 23

A simplified diagram of a point contact transistor is illustrated in Figure 25. Consider the emitter and base as constituting one rectifier and the collector and base another rectifier. Battery A, provides a positive potential to the emitter which effectively biases the emitter in the direction that results in the **greatest** electron flow. The battery B provides a negative potential to the collector which biases the collector in the direction of **least** electron flow. Let us consider what takes place in the point contact transistor with the emitter and collector biased in this manner. Figure 26 illustrates the emitter creating holes in its immediate area and in effect creates

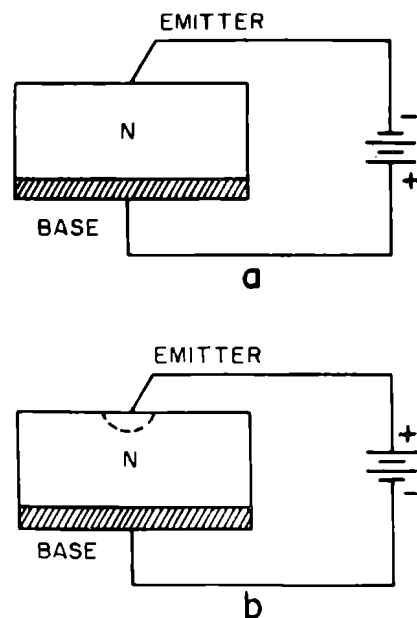

FIGURE 24

a space charge consisting of holes. Since the holes were created by virtually pulling an electron from a covalent bond, it is understandable why adjoining electrons want to fill the hole. Since the closest supply of electrons is present at the collector (negative) the holes tend to move toward the negative potential. During their movement toward the collector some holes are filled by electrons, but because of the very close spacing of the emitter and collector a majority of the holes reach the collector. Keep in mind that the collector is biased negatively and consequently, very little electron flow takes place between the collector and base. However, with the presence of the holes in the vicinity of the collector many more electrons can leave the negative terminal of the battery and enter the collector region and fill the holes. Thus, the presence of the holes in the vicinity of the collector causes a marked reduction in the resistance of the collector region which results in an increase in electron flow.

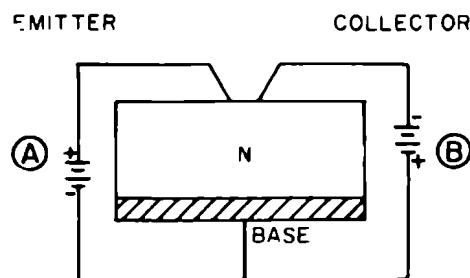

FIGURE 25

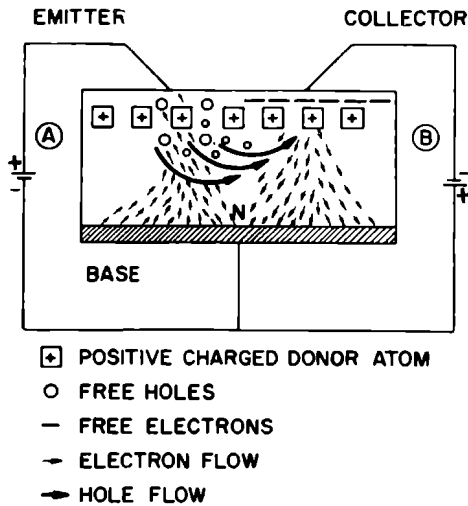

FIGURE 26

From the above theory it can be seen how a signal varying in polarity can be fed to the emitter circuit with the result of corresponding holes being formed in the emitter area. These holes in turn control the resistance of the collector region and result in a corresponding change in electron flow in the collector circuit. Because it takes just a small variation in the electron flow in the emitter circuit to produce and control a greater electron flow in the collector circuit, amplification takes place.

In average point contact transistors, an increase in emitter electron flow of one milliamperere will cause an increase in collector electron flow

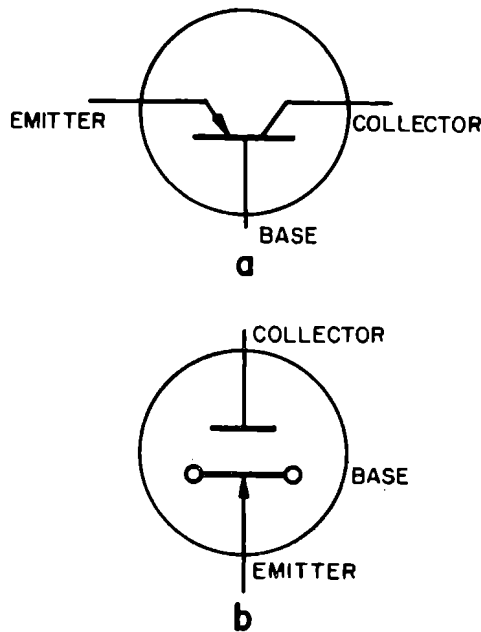

FIGURE 27

of 2.5 milliamperes. The current gain factor of 2.5 is typical of point contact transistors. This figure may seem low when compared with the amplification factor of a valve. However, another factor, the input and the output resistance of the transistor plays an important part. The input resistance is approximately 300 ohms, while the output resistance is approximately 20,000 ohms. It can be seen that there is another gain characteristic namely the resistance gain. The transistor voltage gain equals the current gain times the resistance gain. Therefore, the voltage gain obtainable is comparable to a high- μ valve.

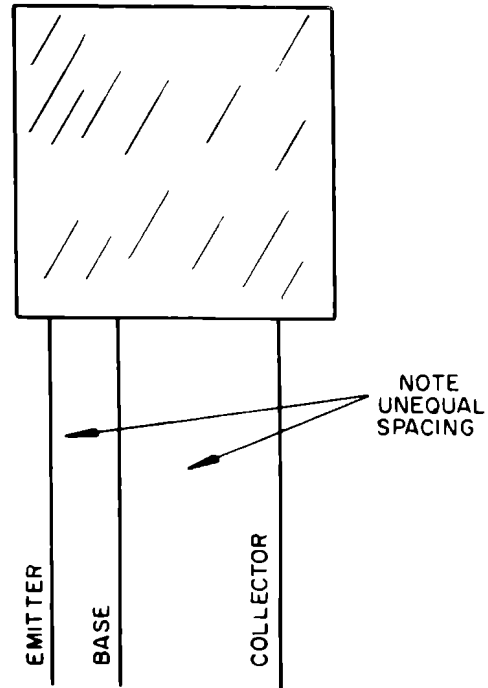

FIGURE 28

TRANSISTOR CHARACTERISTICS

Symbol and Lead Identification

The symbols used for transistors are illustrated in Figure 27. The symbol in Figure 27 (a) is of the conventional type presently in widespread use. The heavy horizontal line represents the base and the two angular line represent the emitter and collector. The arrow head drawn on the emitter indicates the direction of current flow. This provides an aid in identifying the type of transistor. In the case of a junction transistor of the p-n-p type, the arrow is drawn pointing toward the base. An n-p-n type is drawn with the arrow in the opposite direction.

Another symbol used to represent a transistor is illustrated in Figure 27 (b). This is perhaps more representative of the actual transistor construction and relationship of the elements in

comparison to the valve symbol. The arrow also shows the direction of current flow in the emitter.

The leads on an actual transistor are readily identified by the position and spacing of the leads. A "standard" transistor is illustrated in Figure 28. The base lead is the centre lead. The emitter and collector leads are on either side of the base lead. The collector lead can be identified by the larger space existing between it and the base lead.

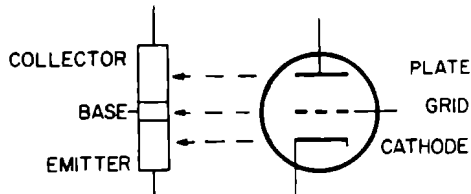

FIGURE 29

Methods of Operation

In general, the transistor can be compared to a thermionic valve. The illustration in Figure 29 shows the similarities. The base is similar to the grid of the valve in that they both serve to control electron flow through the unit. The emitter and cathode supply the source of electron flow. The collector of the transistor and the plate of the valve are similar in that they both are normally part of the output circuit.

The transistor's input and output impedance can be varied by the method in which it is connected in a circuit. Figure 30 illustrates the various methods of operating a transistor. A comparable connection of a thermionic valve is shown below each method. In each instance one electrode is common to both the input and output circuits. The common base type is illustrated in Figure 30 (a). This type of operation is similar to a

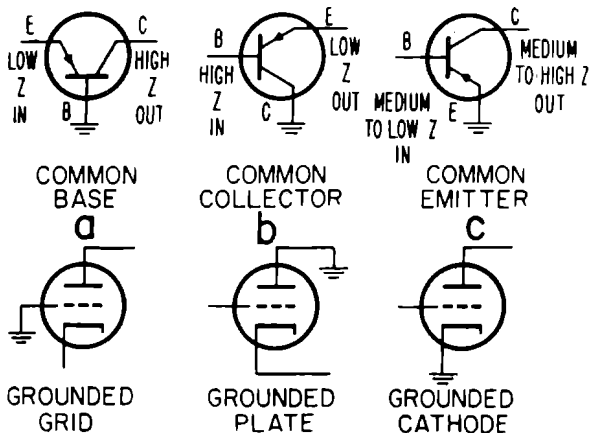

FIGURE 30

valve used as a grounded grid amplifier. The advantage of using a transistor in this manner is that it has a low input impedance and a high output impedance.

The common collector type is illustrated in Figure 30 (b). This is similar to a valve used as a cathode follower. With a common collector, the impedance characteristics of the transistor are such that the input now possesses a high impedance and the output a low impedance.

The final method of operation is the common emitter type and is illustrated in Figure 30 (c). This is similar to a grounded cathode valve circuit. The input impedance is medium to low and the output impedance is medium to high. The grounded emitter is generally employed in conventional circuit applications. For use in special circuits the correct impedance match can be made by choosing the proper method of connection. Thus, almost any impedance ratio can be inserted to satisfy the circuit requirements.

Electrical Characteristics

The manufacturer of transistors generally supplies the mechanical and electrical characteristics in the form of a specification sheet. Let us examine the specifications pertaining to an AWW type 2N109 junction transistor.

The manufacturer tabulates the specifications of transistor units in the following categories; general data, maximum rating, typical operating characteristics and characteristic curves.

General data includes the following:

Electrical:

- Maximum DC Collector Current for dc collector-to-base voltage of -25 volts with emitter open, and at ambient temperature of 25°C. -14#a
- Maximum DC Emitter Current for dc emitter-to-base voltage of -12 volts with collector open, and at ambient temperature of 25°C -14#a

Mechanical:

- Mounting Position any
- Maximum Overall Length 0.697"
- Maximum Seated Length 0.495"
- Maximum Diameter 0.260"
- Case Metal
- Envelope Seals Hermetic
- Base Small-Round Linotetar 3-Pin (JETEC No. E3-25)

Maximum ratings are those values of voltage, current and temperatures that must not be exceeded when operating the units. The values given are important not only to the electronic engineer

but also to the service technician. The maximum ratings for the AWW type 2N109 transistor are as follows:

Maximum Ratings:

Peak Collector-to-Base Voltage	-25 volts
DC Collector-to-Emitter Voltage	-25 volts
Peak Collector Current	-70 ma
Peak Emitter Current	70 ma
Collector Dissipation	
At ambient temp. 25°C	150 mw
At ambient temp. 55°C	50 mw
At ambient temp. 71°C	20 mw
Ambient Temperature (during operation)	70 °C
Storage-Temperature Range	-65 to +85°C

Characteristics:

DC Collector-to-Emitter Voltage	-1 volt
DC Collector Current	-50 ma
Large-Signal DC Current Transfer Ratio	75

The voltages are generally given with respect to the base and the values indicated in volts. Current is given in milliamperes or microamperes and the power dissipation values are given in "watts or milliwatts".

Typical Operating Characteristics are also given to serve as a guide to the engineer who may be designing equipment or the technician servicing the equipment. The following information is for the AWW type 2N109 transistor. This transistor is used primarily for Class B operation, and the operating characteristics are as follows:

Typical Push-Pull Operation:

DC Collector-to-Emitter Supply Voltage	-4.5	-9 volts
DC Base-to-Emitter Voltage	-0.15	-0.15 volt
Peak Collector Current (per transistor)	-35	-40 ma
Zero-Signal DC Collector Current (per transistor)	-2	-2 ma
Max.-Signal DC Collector Current (per transistor)	-11.5	-13 ma
Signal-Source Impedance (per base connection)	375	375 ohms
Load Impedance (per collector)	100	200 ohms
Signal Frequency	1	1 Kc
Circuit Efficiency	60	69%
Power Gain	30	33 db
Total Harmonic Distortion	10%	10%
Max.-Signal Power Output	75	160 mw

Characteristic curves are also included as part of the specification sheet. These curves are similar to the curves furnished for valves and serve a similar purpose. A typical curve is illustrated in Figure 31.

Temperature Effects

All semiconductors are subject to temperature limitations. In well designed germanium transistors the maximum rated temperature is approxi-

mately 185°F (85°C). In most applications temperatures seldom exceed 150°F, therefore, there is sufficient margin of safety. In special application, as in military equipment, it is desirable to operate the equipment over a wide range of temperatures. It is here that the silicon transistor plays an important role. Silicon transistors are available that operate with temperatures of 350°F with no destructive effects.

Frequency Cutoff

The upper frequency limit of transistors is determined by the time required (transit time) for the electrons to pass from the emitter to the collector. By making the base of the transistor thinner the element of time will be reduced and consequently, a higher frequency cutoff obtained. It is along these lines that research engineers are constantly working.

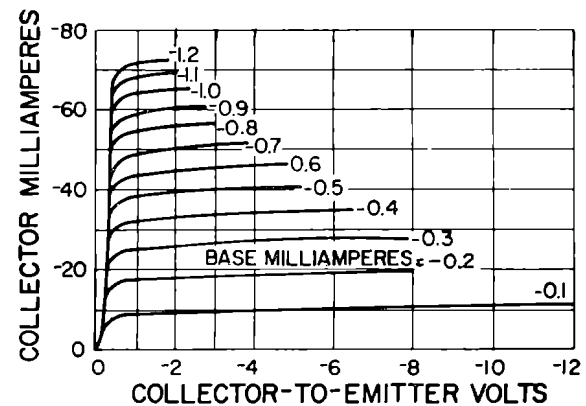

FIGURE 31

In order to obtain transistor performance which is equal to the thermionic valve, the maximum operating frequency should be about 20% of the frequency cutoff. Therefore, in applying this rule, it appears that the minimum cutoff frequency for a portable or home radio receiver with an if of 455 Kc is at least 2-2.5 Mc. For mixer operation of the broadcast band a cutoff of 8 Mc is required. A television vhf rf transistor amplifier operating at 200 Mc would need a 1000 Mc cutoff frequency. There are commercial transistors available that satisfy the requirements for radio and vhf television receivers.

There are other types of transistors which we will discuss in the next section, some of which are capable of operating at uhf television frequencies.

Reliability

The early transistors were incased in plastic. This afforded protection to the unit. Incased transistors used in hearing aids provided good service for over three years. There are several disadvantages, however, in this method of protection; the plastic units did not stand up well at high temperatures, nor could they survive under

extreme moisture conditions. As a result, extensive effort was directed toward the development of hermetically sealed, metal cased units. This method presented new problems; at first it was noticed that some units were subject to abrupt failure in varying percentages due to air leaks. Second, some of the units that were truly sealed, died slowly as the result of the gradual release of internal contaminants. To-day, due to experience gained in the past few years, these problems are practically eliminated. To insure the best possible service, accelerated life tests at high temperatures are used to predict long and useful transistor life.

TYPES OF TRANSISTORS

In the past few years the development of transistors has led to many variations in their design and construction. Let us briefly consider the features of various types.

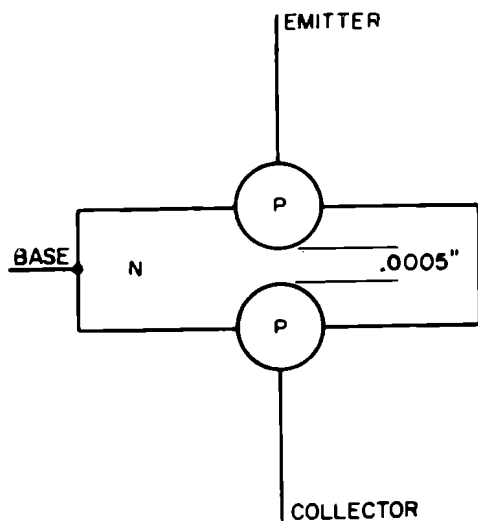

FIGURE 32

The Alloy-Junction Transistor

The alloy method of constructing a junction transistor is illustrated in Figure 32. The base of the transistor is a wafer of n-type semiconductor. The collector and emitter regions are formed by placing pellets of a trivalent impurity on opposite sides of the n-type wafer and applying heat so that the impurity alloys into the n-type semiconductor. This alloying process forms regions of semiconductor material of the p-type which constitute the emitter and collector. Complete control of this process provides separation between the emitter and collector of about .0005 inch which permits a short electron transit time from emitter to collector. In addition, the resistance between the base connection and either the emitter or collector is low because of the relatively

thick n-type wafer used. Finally, the various capacitive effects of the emitter and collector are kept to a minimum because of the very small areas of the p-type regions. Transistors made by this process exhibit 12 db of gain at 10 Mc and a frequency cutoff of approximately 75 Mc. This method of construction is feasible for both p-n-p and n-p-n types of transistors.

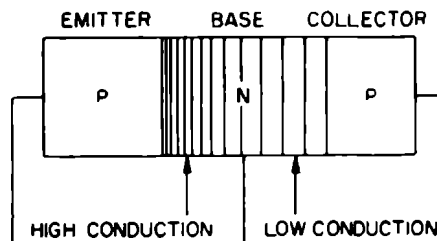

FIGURE 33

The Drift Transistor

The high frequency performance of transistors is limited by three basic factors. These are the time it takes for a hole or electron to travel through the base region, the input resistance, and the collector capacitance. The drift transistor structure minimizes these factors and makes possible devices capable of operating at very high frequencies.

The method used in a drift transistor to reduce the transit time for a given base dimension is to establish a field within the base region that will directly aid the passage of holes or electrons. This field is established by varying the conductivity of the base region so that the conductivity is high near the emitter and low near the collector. The drift transistor illustrated in Figure 33 shows by means of vertical lines the regions of high and low conductivity. The conductivity of the base material is controlled by the distribution of impurity atoms during manufacture. The

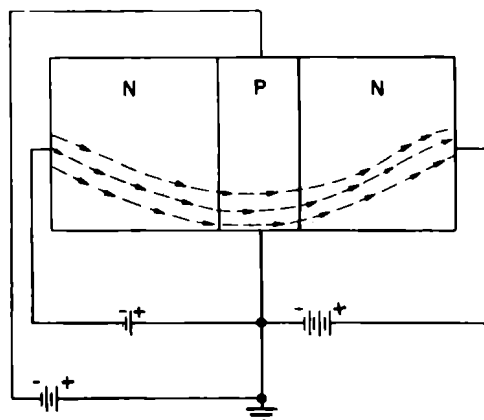

FIGURE 34

highest concentration of impurity atoms is near the emitter and the lowest concentration near the collector. In such a non-uniform conductivity distribution, the electron density (in n-type base material, for example) is greatest in the high conductivity region. The electrons tend to drift out of the region of high concentration. As a result, an electric field is set up due to the positive charge on the atoms from which the electrons left.

The positive charge of the drift field tends to keep the remaining electrons near the emitter side of the base. The holes injected by the emitter are accelerated by the drift field toward the collector because of their opposite charge. The drift field reduces the transit time to one-fourth of that of a conventional alloy-junction transistor of the same base dimension. In addition to an improvement in transit time, the high frequency performance is improved because the high conductivity of the base region near the emitter reduces the input resistance. Also, the low conductivity near the collector region results in a low collector capacitance. Thus, the upper frequency limit of the drift transistor is much higher than that of a conventional p-n-p transistor. These devices are capable of oscillating at frequencies up to 300 Mc and are usable as amplifiers at vhf television frequencies.

The Tetrode Transistor

The tetrode transistor derives its name from an additional lead attached to the base region. Thus, there are four leads extending from a tetrode transistor. Figure 34 illustrates the tetrode transistor. The additional lead is attached to the base region at a position which is on the side opposite to that of the original base connection. The bias voltages necessary to operate this type of transistor are similar to those required by a conventional n-p-n type of transistor. The emitter is biased in the direction of greatest electron flow, and the collector is biased in the direction of least electron flow. The fourth lead is biased at a negative potential which is considerably greater than the normal emitter to base potential. The presence of this negative potential restricts the electrons flowing through the base region so they flow through a relatively narrow area of the base region. The flow of electrons is illustrated in Figure 34.

The advantage of the use of the tetrode structure is an improvement in high-frequency operation. This improvement is obtained from the reduction of emitter and collector capacitance due to the reduced effective area of each region adjacent to the base region, as well as a reduction in base resistance due to the shorter path travelled by the base current. A limitation of the tetrode is its power handling capabilities. In forcing the

electrons to flow in a narrow channel in the base region there is a reduction in the collector current capability. Fortunately, the power requirements for the high frequency stages in many commercial applications are very low. Therefore, this limitation is not of prime importance. A transistor of this type is suitable for use in if stages of television receivers.

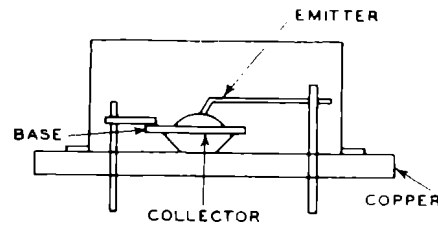

FIGURE 35

Power Transistors

Along with high current and voltage capabilities, the effective dissipation of heat is one of the prime requirements for a power transistor. In some circuit configurations an increase in transistor temperature will cause a bias point shift resulting in an increase in dissipation and hence increase the device temperature even more. This cycle can continue until "thermal runaway" occurs, damaging the transistor. In properly designed circuits this effect can be minimized. However, unless the heat generated can be removed efficiently, the transistor junction temperature will rise to an undesirably high level and, in time, the performance of the transistor will be significantly degraded.

Most of the heat dissipated in a transistor is generated at the collector junction. In order to simplify removal of this heat the collector dot is generally fastened directly to the case of the unit (see Figure 35). Provision is then made for the case to be directly connected to a chassis or other heat dissipating surface. Power transistors of the structure described are now available and are capable of dissipating up to 25 watts in practical applications.

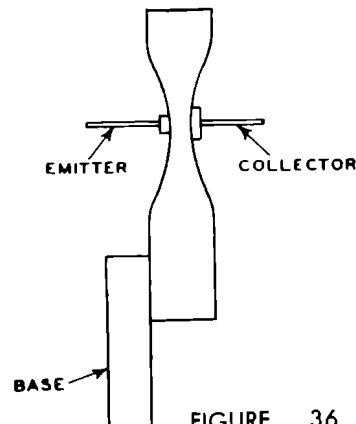

FIGURE 36

Surface Barrier Transistors

The structure of the surface barrier transistor is similar to that of an alloy transistor. One major difference in structure is that instead of alloying dots deeply into the base material to obtain a narrow base width, two wells are electrochemically etched into the base material until they are separated by only a few tenths of a mil. Indium is then plated on both sides and emitter and collector contacts made (see Figure 36). Such a unit has frequency cutoff in the order of 40 Mc.

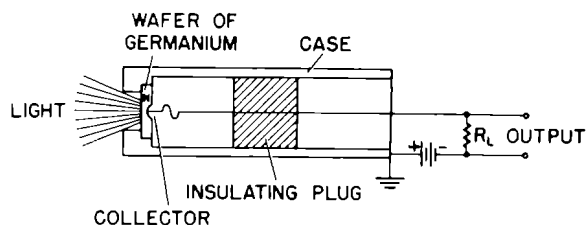

FIGURE 37

Recently, the micro-etching techniques used to make surface barrier transistors have been applied to "drift" transistor structures. The units produced by this process have been termed micro-alloy diffused transistors. Such a unit has a frequency cut off greater than 250 Mc and finds wide application in high speed computer circuits.

Photosensitive Transistors

Photosensitive transistors can be divided into three groups according to their construction; they are, the point contact, the p-n junction and the photo-transistor. These various types of photo-sensitive transistors are used to control photo-electric equipment such as flame detectors, automatic door openers, automobile light dimmers, burglar alarms and counters. The mechanical features of these photosensitive transistors are similar to the conventional transistor in that they are lightweight, rugged, etc.

A photosensitive transistor of the **point contact** type is illustrated in Figure 37. The heart of the device is a wafer of germanium. One side has a spherical "dimple" ground into it. This is done to reduce the thickness at the centre to about .003 inch. The wafer is force-fitted into one end of a metal cartridge and a pointed phosphor-bronze wire is brought into contact with the wafer at its centre. This wire is called the collector. The other end of the wire fastens to a metal pin contact embedded in an insulating plug which is positioned at the opposite end of the case. The second electrical contact to this photo-transistor is the case itself.

The wafer is made of n-type semiconductor and is biased in the direction of **least** current flow. When light is directed on the germanium wafer a number of covalent bonds are broken,

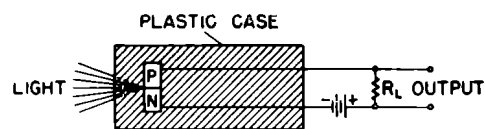

FIGURE 38

thus producing an equal number of holes and electrons. Under the influence of the applied electric field, the electrons travel to the positive terminal of the battery and the holes go to the negative battery terminal. It is because of the additional carriers of current made available by the action of light on the n-type germanium, that there is an increase in current flow through the circuit.

To insure that maximum current response is obtained when the light rays fall in the vicinity of the point contact a small glass lens is used to focus the light rays into a narrow beam which is restricted to the desired area of the n-type wafer.

A photosensitive transistor of the p-n junction assembly may also be devised with comparable results. A junction phototransistor is illustrated in Figure 38. The response will be greatest when the light is directed at the junction.

Another form of a photosensitive transistor is the phototransistor. This unit employs an n-p-n type of construction as illustrated in Figure 39. Only the central base section is made photosensitive. The bias battery is adjusted so that very little current flows through the transistor, however, when light is focused on the base section, holes are formed in sufficient quantity to produce an increase in current to operate a relay directly. A practical application of this type of phototransistor is in the automatic auto headlight dimmer.

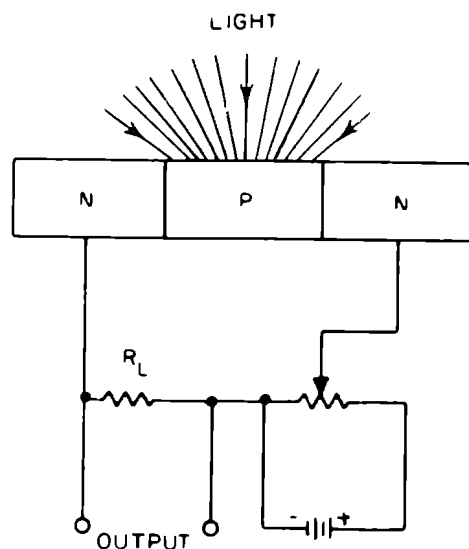

FIGURE 39

