

EMITTER		USE	Plate Diss. Watts ²	Plate Volts	Negative Grid Volts	Screen Volts	Plate Current Ma.	Screen Current Ma.	Plate Resis. Ohms	Trans. M
Volts	Amps.									
12.6	0.550	Det. Power Amp. Driver	12.6	G2 = 2	G1 = 12.6	8	75	480	1
(Space-Charge Grid Operation.)										
12.6*	0.600	T.V. Damper	6.5	Characteristics Same as Type 6DM4. (12DM4 Designed for						
12.6*	0.450	Power Amp.	6.0	110	7.5	110	49.0	4.0	14000	7
6.3	0.260	A-F Amp.	1.1	Low Noise and Low Microphonism Version of Type 12AX7.						
12.6	0.130									
12.6*	0.600	T.V. Damper	6.0	Characteristics Same as Type 6DQ4. (12DQ4 Designed for						
12.6*	0.600	Horiz. Defl. Amplifier	16.5	Characteristics Same as Type 6DQ6A. (12DQ6A Designed for						
12.6*	0.600	Horiz. Defl. Amplifier	17	Characteristics Same as Type 6DQ6B. (12DQ6B Designed for						
12.6/6.3*	0.300/0.600	Video Amp.	6.5	200	68 [■]	125	26	5.6	53000	100
12.6	0.400	Det. Power Driver	12.6	2.2 Meg ⁴	G1 = 12.6	35-15†	80
				12.6	2.2 Meg ⁴	G1 = 12.6	35-11†	80
12.6*	0.600	Vert. Defl. Amplifier	9.0	Characteristics and Ratings Same as Type 6DT5. (12DT5 D						
12.6	0.150	Quad FM Det.	1.7	Characteristics Same as Type 6DT6.						
6.3	0.300	A-F Amp.	1.1	Characteristics Same as Type 12AX7. Controlled for Hum an						
12.6	0.150	A-F Amp.	2.75	100	270 [■]	3.7	15000	4
				250	200 [■]	10	10900	5
12.6	0.250	Det. Power Amp. Driver	12.6	2.2 Meg ⁴	12.6	12	1.5	6000	6
12.6	0.150	Det. Amp.	12.6	2.2 Meg ⁴	0.4	...	19000
12.6	0.375	Detector, Pwr. Amp. Dr.	12.6	18 Ohm [■] and 4.7 Meg ⁴	G1 = 12.6	6.8	54	900	8
(Space Charge Grid Operation)										
12.6*	0.600	Vert. Defl. Amplifier	11	Max. Peak Positive Plate Voltage = 2200 Volts. Max. D.C. (
				200	22.5	150	55	2.0	15000
6.3	0.300	Sect. 1 A-F	1.2	100	1.0	0.5	...	80000
12.6	0.150	Voltage Amp.		250	2.0	1.2	...	62500
		Sect. 2 A-F	3.3	100	0	11.8	...	6500
		Phase Inverter		250	8.5	10.5	...	7700
12.6	0.450	Dissimilar Tri's	0.5	12.6	1.5 Meg ⁴	1.9	...	3520
		Voltage Amp.	0.5	12.6	1.0 Meg ⁴	7.5	...	970
		Pwr. Amp. Dr.								

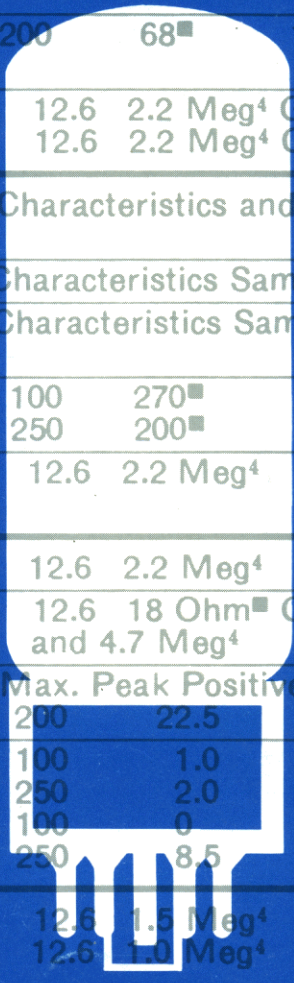

Characteristics of Sylvania Receiving Tubes

12	0.450	A-F Voltage Amp. and Power Amp.	.825	Characteristics Same as Type 6DZ8. (12DZ8 Designed for S						
			7.15							
12.6	0.190	I-F Amp.	12.6	G1 = 10 Meg ⁴	12.6	3.2	1.4	32000
G3 = 0										
12.6	0.225	FM Osc. FM Amp.	12.6	0	2.4	...	6000	4
				12.6	0	12.6	0.66	0.28	750000	2
12.6	0.450	S.T. A1 Amp.	6.25	110	4.0	110	32	4	14000	8
				125	4.5	125	37	7	14000	8
12.6*	0.450	Vert. Defl.	11	Characteristics Same as Type 6EE6. (12EE6 Designed for						

25¢

Tubes for Color Television

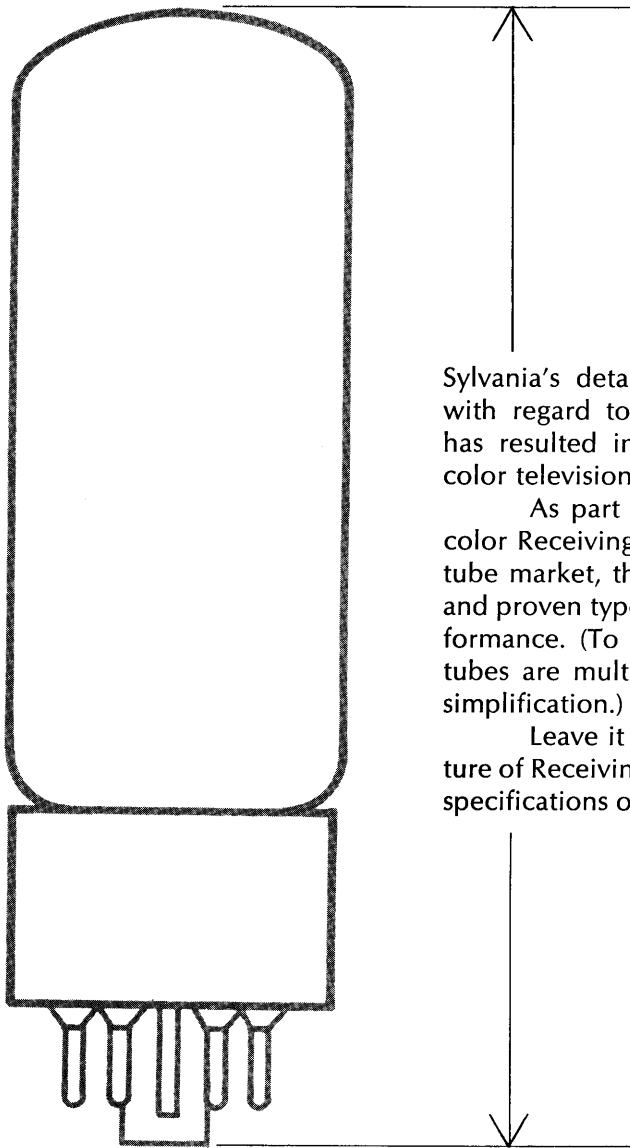

Sylvania's detailed study of color TV circuit functions, with regard to the performance characteristics desired, has resulted in a superior line of Receiving Tubes for color television.

As part of Sylvania's broad program to provide a color Receiving Tube line specifically geared to the color tube market, the study and continued evaluation of new and proven types assure optimum initial and long-life performance. (To assure cost and space savings, many new tubes are multiple-section types which allow for circuit simplification.)

Leave it to Sylvania to be a leader in the manufacture of Receiving Tubes that meet the demanding, exacting specifications of color television!

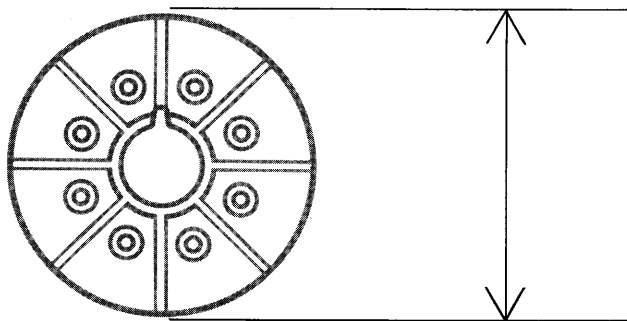

SYLVANIA RECEIVING TUBE CHARACTERISTICS CHART

This booklet contains the very latest television and radio receiving tubes in addition to many industrial tubes. It is intended as a quick reference to pertinent characteristics and basing connections.

Resistance/capacitance coupled amplifier data and a listing of tube types by basing connections are also included. This valuable supplementary information is presented in the latter pages of the booklet.

Please note that all types listed may not be available from Sylvania. They are included for your reference in finding substitutes, etc. Consult our price list for types currently available. The data published here has been compiled from various sources and while believed to be accurate, no responsibility can be assumed in case of error.

The majority of the information presented in the chart is self-explanatory, requiring only a few footnotes for clarification. The *Bulb Size or Style* column and the *Emitter* column are the only columns requiring additional comment.

BULB SIZE OR STYLE COLUMN

T-1 to T-18—Numbers 1 to 18 indicate nominal bulb diameter in eighths of an inch.

T, ST, TT—T—Straight sided bulb, ST—dome topped tapered bulb, TT—large straight sided bulb with top and bottom curved.

Metal—Octal base, T-8 metal envelope.

Lock-in—Lock-in base, T-9 glass bulb.

9-T9—Conventional 9 pin miniature base with T-9 bulb.

M-N—Metal Cased Nuvistor.

Comp.—Compactron, 12 pin base with T-9 or T-12 bulb, exhaust tip located at bottom.

NOVAR—9 pin base (large pin circle .687" dia. and large dia. pins .04") with T-9 or T-12 bulb.

MAGNOVAL—9 pin base (large pin circle .687" dia. and large dia. pins .05") bonded to T-9 bulb, exhaust tip located at bottom.

CERAMIC and METAL—Planar Construction, ceramic and metal envelope, thimble sized, baseless.

EMITTER COLUMN. When replacing tubes in series string television receivers, attention should be given to the complete type number including the suffix. Prototypes should not be substituted for series string types.

Heater voltage, heater current and heater-cathode voltage ratings of series string tubes may differ widely from those of their prototypes. All series string types have controlled heater warm-up time. In addition, heater current production tolerances for series string tubes are tighter to assure proper steady state voltage distribution. Failure to recognize these differences may result in poor set performance and premature tube failure.

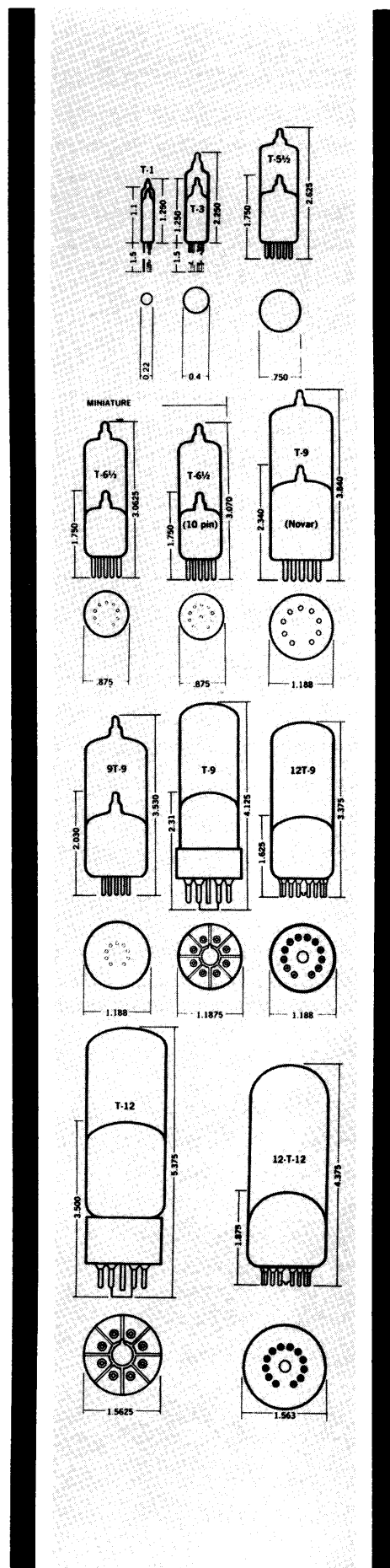

SYLVANIA TUBES

TYPE	CONSTRUCTION			EMITTER		USE	Plate Diss. Watts ²	Plate Volts	Negative Grid Volts	Screen Volts	Plate Current Ma.	Screen Current Ma.	Plate Resis. Ohms	Transcon-ductance Micros.	Amplifi-cation Factor	Ohms Load for Stated Power Output	Power Output Milli-watts
	Bulb Size or Style ¹	Class	Basing Diag.	Volts	Amps.												
OA2 GB-OA2WA (3)	T-5½	Diode	5B0	Voltage Regulator with Starting Voltage at 185, Operating Voltage 150, Operating Current 5 to 30 Ma.											
OA3 OA3A	ST-12 T-9	Diode	4AJ	Voltage Regulator with Starting Voltage at 165, Operating Voltage 75, Operating Current 5 to 40 Ma.											
OA4G	ST-12	Gas Triode	4V	Relay Tube Peak Cathode Ma. = 100 D.C. Cathode Ma. = 25 Max. Starter Anode Drop = 60 V. Approx. Anode Drop = 70 V. Approx.											
OA5	T-5½	Gas Pentode	OA5	Switching	750										
OB2 GB-OB2WA (3)	T-5½	Diode	5B0	Voltage Regulator with Starting Voltage at 115, Operating Voltage 105, Operating Current 5 to 30 Ma.											
OB3 OB3A	ST-12 T-9	Diode	4AJ	Voltage Regulator with Starting Voltage at 125, Operating Volts 90, Operating Current 5 Ma. Min., 30 Ma. Max.											
OC2	T-5½	Diode	5B0	Voltage Regulator with Starting Voltage at 105, Operating Voltage 75, Operating Current 5 Ma. Min., 30 Ma. Max.											
OC3 OC3A	ST-12 T-9	Diode	4AJ	Voltage Regulator with Starting Voltage at 135, Operating Volts 105, Operating Current 5 Ma. Min., 40 Ma. Max.											
OD3 OD3A	ST-12 T-9	Diode	4AJ	Voltage Regulator with Starting Voltage at 180, Operating 150 Volts, Operating Current 5 Ma. Min., 40 Ma. Max.											
OY4 OY4G	Metal T-7	Gas Diode	4BU 4BU	Ionic	H-W Rect.	117 A.C. Volts Per Plate, RMS, 75 Ma. Max., 40 Ma. Min. Output Current. Starter Anode Connects to Anode thru 10 Megohms By-Passed with .002 pf.									
OZ4	Metal	Gas Duodi.	4R	Ionic	F-W Rect.	300 A.C. Volts Per Plate, RMS, 90 Ma. Max., 30 Ma. Min. Output Current.									
OZ4A	Metal	Gas Duodi.	4R	Ionic	F-W Rect.	300 A.C. Volts Per Plate, RMS, 110 Ma. Max., 30 Ma. Min. Output Current.									
OZ4G	T-7	Gas Duodi.	4R	Ionic	F-W Rect.	300 A.C. Volts Per Plate, RMS, 90 Ma. Max., 30 Ma. Min. Output Current.									
1A3	T-5½	Diode	5AP	1.4	0.150	Detector	Half Wave Cathode Type Rectifier for H. F. Use.									
1A5GT	T-9	Power Pent.	6X	1.4	0.050	Power Amp.	85 4.5 85 3.5 0.7 300000 800 25000 100 90 4.5 90 4.0 0.8 300000 850 25000 115									
1A7GT	T-9	Heptode	7Z	1.4	0.050	Converter	90 0.0 90 0.6 1.2 600000 250 ^a (Ga = 90 V. Max. 1.2 Ma.)									
1AC5	T-3	Pentode	8CP	1.25	0.040	Power Amp.	30 2.0 30 0.5 0.1 200000 450 50000 5 45 3.0 45 1.0 0.2 170000 600 40000 15 67.5 4.5 67.5 2.0 0.4 150000 750 25000 50									
1AD2	T-9	Diode	12DQ	1.25	0.200	Flyback H-W Rectifier	Maximum Peak Inverse Plate Voltage = 26,000 Volts, Maximum Peak Plate Current = 50 Ma., Maximum Average Output Current = 0.5 Ma.									
1AD5	T-3	Pentode	8CP	1.25	0.040	R-F Amp.	30 0 30 0.45 0.16 700000 430 50000 5 45 0 45 0.9 0.35 700000 580 50000 15 67.5 0 67.5 1.85 0.75 700000 735 25000 50									
1AE4	T-5½	Pentode	6AR	1.25	0.100	R-F Amp.	90 0 90 3.5 1.2 500000 1550 50000 5									
1AF4	T-5½	Pentode	6AR	1.4	0.025	R-F Amp.	67.5 0 67.5 1.2 0.32 2.2 Meg. 925 50000 5 90 0 90 1.8 0.55 1.8 Meg. 1050 50000 15									
1AF5	T-5½	Diode Pent.	6AU	1.4	0.025	Det. Amp.	67.5 0 67.5 0.7 0.25 2.8 Meg. 550 50000 5 90 0 90 1.1 0.4 2.0 Meg. 600 50000 15									
1AG4	T-2X3	Pentode	1AG4	1.25	0.040	Power Amp.	41.4 3.6 41.4 2.4 0.6 180000 1000 12000 35									
1AG5	T-2X3	Diode Pent.	1AG5	1.25	0.030	Det. Amp.	45 2.0 45 0.28 0.12 2.5 Meg. 250 50000 5									
1AH4	T-2X3	Pentode	1AH4	1.25	0.040	R-F Amp.	45 5 Meg. ⁴ 45 0.75 0.2 1.5 Meg. 750 50000 5 67.5 5 Meg. ⁴ 67.5 0.75 0.2 2.0 Meg. 750 50000 15									
1AJ2	Comp. T-9	Diode	12EL	1.25	0.200	Flyback H-W Rect.	Maximum Peak Inverse Plate Voltage = 26,000 Volts. Maximum Peak Plate Current = 50 Ma. Maximum Average Output Current = 0.5 Ma.									
1AJ5	T-2X3	Diode Pent.	1AJ5	1.25	0.040	Det. Amp.	45 0 45 1.0 0.3 300000 425 50000 5									
1AK4	T-2X3	Pentode	1AK4	1.25	0.020	Class A1 Amp.	45 0 45 0.75 0.2 150000 750 (Screen Supply = 67.5 Volts Thru .11 Meg. Res.) 67.5 0 67.5 0.75 0.2 200000 750									
1AK5	T-2X3	Diode Pent.	1AK5	1.25	0.020	Det. Amp.	45 0 45 0.5 0.2 400000 280 50000 5									
1AN5	T-5½	Pentode	7ES	1.4	0.025	I-F Amp.	90 0 62 1.7 0.7 450000 940 G1 to G2 = 20									
1AU2	T-6½	Diode	9U	1.10	0.190	Focus H-W Rect.	Maximum Peak Inverse Plate Voltage = 8250 Volts. Maximum Peak Plate Current = 11 Ma. Maximum Average Plate Current = 0.6 Ma.									

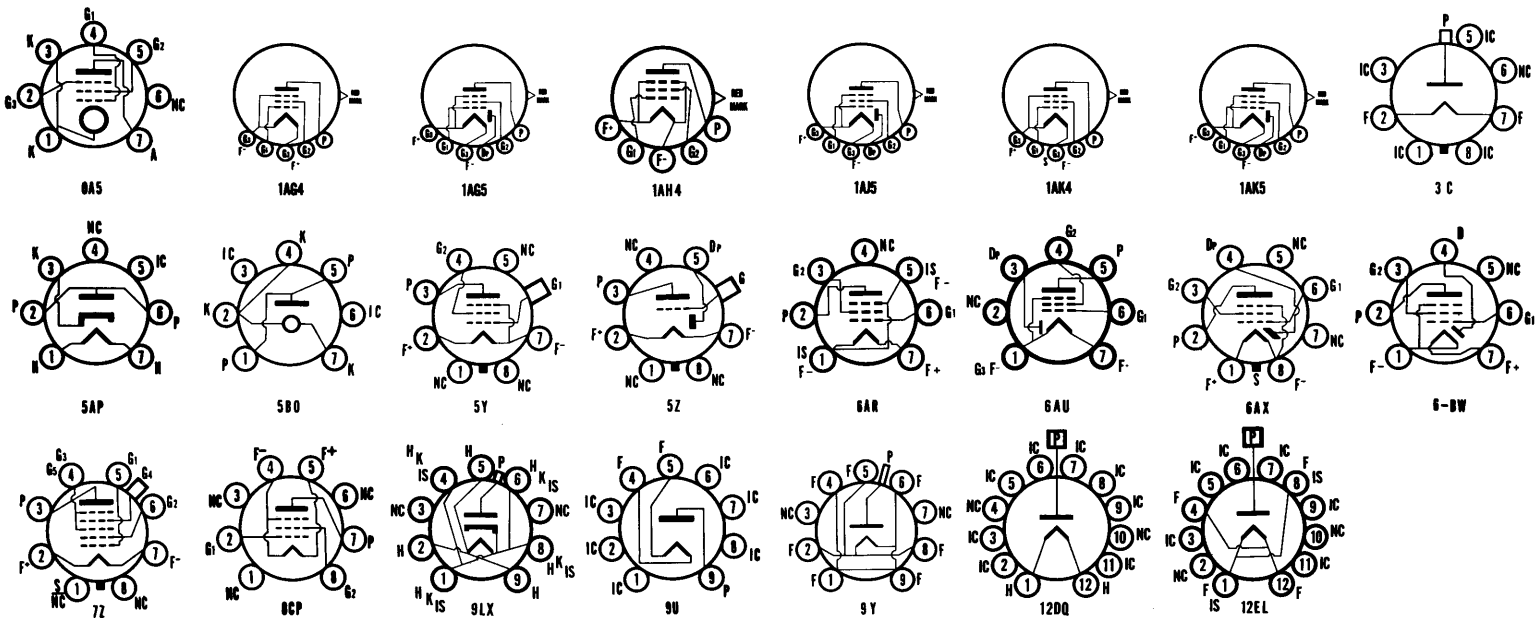

SYLVANIA TUBES

TYPE	CONSTRUCTION			EMITTER		USE	Plate Diss. Watts ²	Plate Volts	Negative Grid Volts	Screen Volts	Plate Current Ma.	Screen Current Ma.	Plate Resis. Ohms	Transconductance Micros.	Amplification Factor	Ohms Load for Stated Power Output	Power Output Milli-watts		
	Bulb Size or Style ¹	Class	Basing Diag.	Volts	Amps.														
1S5	T-5½	Diode Pent.	6AU	1.4†	0.050	Det. Amp.	67.5	0.0	67.5	1.6	0.4	60000	625		
1S6	T-3	Diode Pent.	8DA	1.25†	0.040	Det. Amp.	30 45 67.5	0 0 0	30 45 67.5	0.33 0.75 1.6	0.1 0.21 0.4	500000 500000 400000	330 475 600		
1T4	T-5½	Pentode	6AR	1.4†	0.050	R-F Amp.	45 90	0.0 0.0	45 67.5	1.7 3.5	0.7 1.4	350000 500000	700 900		
1U4	T-5½	Pentode	6AR	1.4†	0.050	R-F Amp.	90	0	90	1.6	0.45	1.6 Meg.	900		
1U5	T-5½	Diode Pent.	6BW	1.4†	0.050	Det. Amp.	Characteristics Same as Type 1S5.											
1U6	T-5½	Heptode	7DC	1.4†	0.025	Converter	67.5 90	0 0	45 45	0.5 0.6	0.7 0.6	500000 500000	260 ^A 275 ^A	(Ga = 67.5 V., 1.0 Ma.) (Ga = 90 V., 1.1 Ma.)				
1V2	T-6½	Diode	9U	0.625†	0.300	H-W Rect.	Television Service. RF or Flyback Supply. Peak Inverse Volts = 8250, Output = 0.6 Ma.											
1V6	T-2x3	Tri. Pentode	1V6	1.25†	0.040	R-F Osc. R-F Amp.	45	1 Meg. ¹ 5 Meg. ¹ 45	0.4 0.4	IG1 = 12 μa Conv. = 200 ^A		
1X2B	T-6½	Diode	9Y	1.25†	0.200	H-W Rect.	Television Service, RF or Flyback Supply. Peak Inverse Volts = 22 KV, Output = 0.5 Ma.											
2A3	ST-16	Triode	4D	2.5†	2.500	S.T. A1 Amp. P.P.AB1 Amp.	16.5	250 300	45.0 62.0	60.0 80-147†, Push Pull, Fixed Bias	800	5250	4.2	2500 3000†	3500 15000		
2AF4A 2AF4B	T-5½	Triode	7DK	2.35*	0.600	UHF Osc.	2.5	Characteristics Same as Type 6AF4A. Type 2AF4B has Higher-Cathode Voltage Ratings than Otherwise Identical Type 2AF4A.											
2AH2	Comp. T-9	Diode	12DG	2.5†	0.300	Flyback H-W Rect.	Maximum Peak Inverse Plate Voltage = 30,000 Volts. Maximum Peak Plate Current = 80 Ma. Maximum Average Plate Current = 1.5 Ma.											
2AS2	Comp. T-9	Diode	12EW	2.5	0.330	Flyback H-W Rect.	Maximum Peak Inverse Plate Voltage = 30,000 Volts. Maximum Peak Plate Current = 80 Ma. Maximum Average Plate Current = 1.5 Ma.											
2B3	T-9	Diode	8HC	1.75†	0.250	H-W Rect.	Television Service. Flyback Supplies. Peak Inverse Volts = 22 KV. Output = 0.5 Ma.											
2BN4A	T-5½	Triode	7EG	2.35*	0.600	VHF Amp.	2.42	Characteristics Same as Type 6BN4A. (2BN4A Designed for Series String Receivers.)											
2C21	ST-12	Duotriode	7BH	6.3	0.600	Amplifier Power Amp.	2.3	250 250	16.5 60.0	8.3 20.0	7600	1375	16.4	20000	3500		
2C22	T-9	Triode	4AM	6.3	0.300	Amplifier	3.3	300	10.5	11.0	6600	3000	20.0		
2C50	T-9	Duotriode	8BD	12.6	0.300	Amplifier	3.85	200	11	18	3450	2900	10		
2C51	T-6½	Duotriode	8CJ	6.3	0.300	Amplifier	1.65	150	240 ^M	8.2	6500	5500	35		
2C52	T-9	Duotriode	8BD	12.6	0.300	Amplifier	1.65	250	2.0	1.3	1900	100		
2CW4	M-N	Triode	12AQ	2.1*	0.450	VHF Amp.	1.0	Characteristics Same as Type 6CW4. (2CW4 Designed for Series String Receivers.)											
2CY5	T-5½	Tetrode	7EW	2.4*	0.600	VHF Amp.	2.0	Characteristics Same as Type 6CY5. (2CY5 Designed for Series String Receivers.)											
2D21	T-5½	Gas Tetrode	7BN	6.3	0.600	Relay Tube	400	5	Average Cathode Current = 100 Max. Ma., Averaged over any 30 Sec. Interval.							
2DF4	T-6½	Pentode	9JL	1.25† 2.50†	0.345 0.690	Class "C" Power Amp.	4.5	120	3.6	120	37	3.5	6850		
2DS4	M-N	Triode	12AQ	2.1*	0.450	VHF Amp.	1.0	Characteristics Same as Type 6DS4. (2DS4 Designed for Series String Receivers.)											
2DV4	M-N	Triode	12EA	2.1*	0.450	UHF Osc.	1.0	Characteristics Same as Type 6DV4. (2DV4 Designed for Series String Receivers.)											
2DX4	T-5½	Triode	7DK	2.4*	0.600	UHF Osc.	2.2	Characteristics Same as Type 6DX4. (2DX4 Designed for Series String Receivers.)											
2DY4	T-5½	Triode	7DK	2.05*	0.450	UHF Osc.	1.5	Characteristics Same as Type 6DY4. (2DY4 Designed for Series String Receivers.)											
2DY4A	T-5½	Triode	7DK	2.05*	0.450	UHF Osc.	1.5	Characteristics Same as Type 6DY4A. (2DY4A Designed for Series String Receivers.)											
2DZ4	T-5½	Triode	7DK	2.35*	0.600	UHF Osc.	2.3	Characteristics Same as Type 6DZ4. (2DZ4 Designed for Series String Receivers.)											
2E26	T-9	Beam Pent.	7CK	6.3	0.800	Class C Amp.	10	500	40.0	185	60.0	11.0	Driving Power = 0.12 Watts. D.C. Grid No. 1 Current = 3.0 Ma.			2000			
2EA5	T-5½	Tetrode	7EW	2.4*	0.600	VHF Amp.	3.25	Characteristics Same as Type 6EA5. (2EA5 Designed for Series String Receivers.)											
2EN5	T-5½	Duodiode	7FL	2.1*	0.450	Phase-Comparator	Diode Current for Continuous Operation (Each Plate) = 20 Ma. Diode Characteristics with 5.0 Volts Applied. Ib = 20 Ma. (Each Plate—Test Condition Only.)											
2ER5	T-5½	Triode	7FP	2.3*	0.600	VHF Amp.	2.2	Characteristics Same as Type 6ER5. (2ER5 Designed for Series String Receivers.)											
2ES5	T-5½	Triode	7FP	2.35*	0.600	VHF Amp.	2.2	Characteristics Same as Type 6ES5. (2ES5 Designed for Series String Receivers.)											
2EV5	T-5½	Tetrode	7EW	2.4*	0.600	VHF Amp.	3.25	Characteristics Same as Type 6EV5. (2EV5 Designed for Series String Receivers.)											
2FH5	T-5½	Triode	7FP	2.35*	0.600	R-F Amp.	2.2	Characteristics Same as Type 6FH5. (2FH5 Designed for Series String Receivers.)											

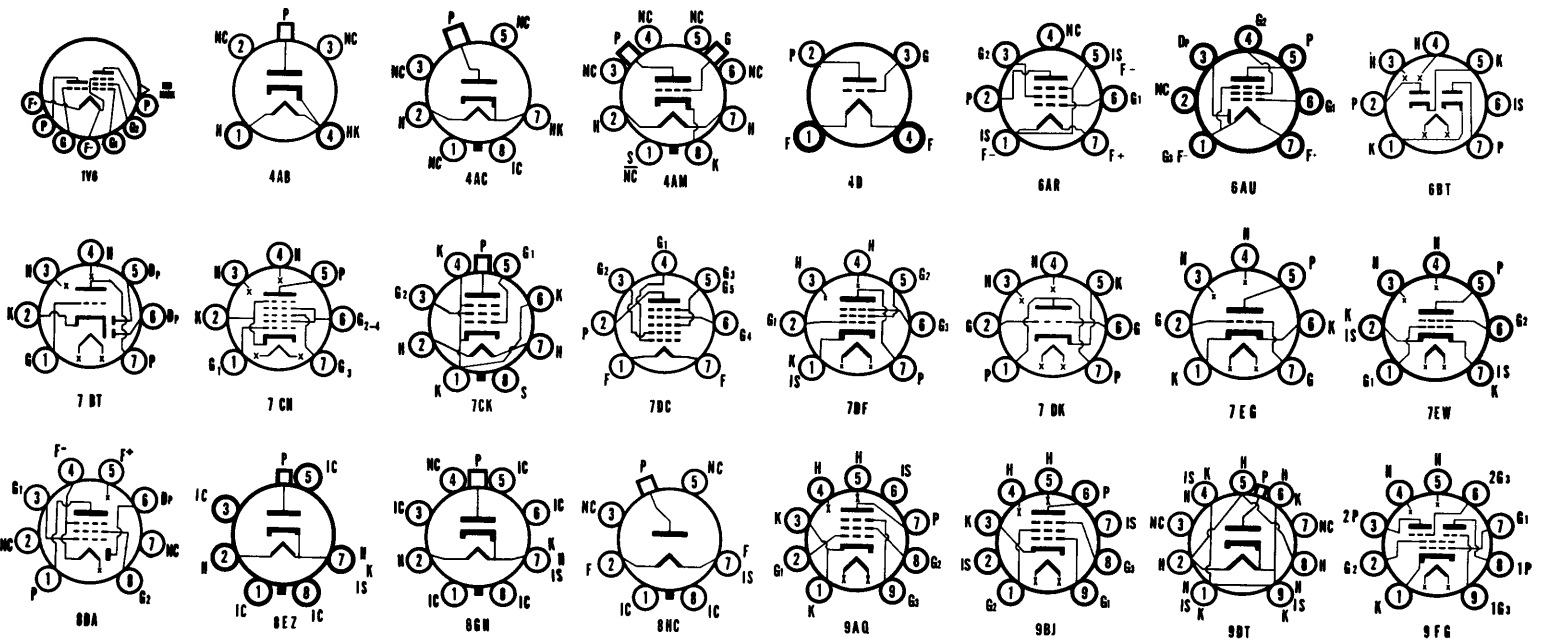

AVERAGE CHARACTERISTICS

TYPE	CONSTRUCTION			EMITTER		USE	Plate Diss. Watts ²	Plate Volts	Negative Grid Volts	Screen Volts	Plate Current Ma.	Screen Current Ma.	Plate Resis. Ohms	Transconductance Micros.	Amplification Factor	Ohms Load for Stated Power Output	Power Output Milli-watts
	Bulb Size or Style ¹	Class	Basing Diag.	Volts	Amps.												
2FQ5	T-5½	Triode	7FP	2.3*	0.600	VHF Amp.	2.5	Characteristics Same as Type 6FQ5. (2FQ5 Designed for Series String Receivers.)									
2FQ5A	T-5½	Triode	7FP	2.3*	0.600	VHF Amp.	2.5	Characteristics Same as Type 6FQ5A. (2FQ5A Designed for Series String Receivers.)									
2FS5	T-5½	Shadow Grid Beam Pent.	7GA	2.4*	0.600	VHF Amp.	3.2	Characteristics Same as 6FS5. (2FS5 Designed for Series String Receivers.)									
2FY5	T-5½	Triode	7FP	2.4*	0.600	VHF Amp.	2.2	Characteristics Same as Type 6FY5. (2FY5 Designed for Series String Receivers.)									
2FV6	T-5½	Tetrode	7FQ	2.4*	0.600	VHF Amp.	2.0	Characteristics Same as Type 6FV6. (2FV6 Designed for Series String Receivers.)									
2GK5	T-5½	Triode	7FP	2.3*	0.600	VHF Amp.	2.5	Characteristics Same as Type 6GK5. (2GK5 Designed for Series String Receivers.)									
2GU5	T-5½	Pentode	7GA	2.4*	0.600	VHF Amp.	3.0	Characteristics Same as Type 6GU5. (2GU5 Designed for Series String Receivers.)									
2GW5	T-5½	Triode	7GK	2.45*	0.600	VHF Amp.	2.5	Characteristics Same as Type 6GW5. (2GW5 Designed for Series String Receivers.)									
2HA5	T-5½	Triode	7GM	2.2*	0.600	VHF Amp.	2.6	Characteristics Same as Type 6HA5. (2HA5 Designed for Series String Receivers.)									
2HK5	T-5½	Triode	7GM	2.3*	0.600	VHF Amp.	2.3	Characteristics Same as Type 6HK5. (2HK5 Designed for Series String Receivers.)									
2HM5	T-5½	Triode	7GM	2.4*	0.600	VHF Amp.	2.2	Characteristics Same as Type 6HM5. (2HM5 Designed for Series String Receivers.)									
2HR8	T-6½	Pentode	9BJ	2.5*	0.600	Amplifier	1.0	250	2	140	3	0.6	2500	2000	38
2T4	T-5½	Triode	7DK	2.35*	0.600	UHF Osc.	3.85	Characteristics Same as Type 6T4. (2T4 Designed for Series String Receivers.)									
2X2	ST-12	Diode	4AB	2.5♦	1.750		Maximum Inverse Plate Voltage = 12,500 Volts, Maximum Peak Current = 60 Ma. Maximum Average Current = 7.5 Ma., Maximum RMS Supply Voltage = 5500 Volts. Characteristics Same as 2X2.									
2X2A(3)																	
3A2	T-6½	Diode	9DT	3.15	0.220	H-W Rect.	TV Service. Peak Inverse Volts = 18 KV. Peak Current = 88 Ma. Average Current = 1.5 Ma.									
3A3	T-9	Diode	4AC	3.15	0.220	H-W Rect.	TV Service. Peak Inverse Volts = 30 KV. Peak Current = 80 Ma. Average Current = 1.7 Ma.									
3A4	T-5½	Pentode	7BB	1.4♦ 2.8♦	0.200 0.100	Power Amp.	2.5	135 150	7.5 8.4	90 90	14.8 13.3	2.6 2.2	90000 100000	1900 1900	8000 8000	600 700
3A5	T-5½	Duotriode	7BC	1.4♦ 2.8♦	0.220 0.110	Amplifier	0.55	90 135	2.5 20.0	3.7 30.0	8300 Push-Pull Class C R.F. Amp.	1800	15	2000
3AF4A	T-5½	Triode	7DK	3.2*	0.450	UHF Osc.	2.5	Characteristics Same as Type 6AF4A.									
3AF4B	T-5½	Triode	7DK	3.2*	0.450	VHF Osc.	2.7	Characteristics Same as Type 6AF4A. (3AF4B has Peak Positive and Negative Heater Cathode Voltages of 180 Volt.)									
3AL5	T-5½	Duodiode	6BT	3.15*	0.600	Detector	Characteristics Same as Type 6AL5. (3AL5 Designed for Series String Receivers.)									
3AT2	T-9	Diode	12EX	3.15	0.220	Flyback H-W Rect.	Maximum Peak Inverse Plate Voltage = 30,000 Volts. Maximum Peak Plate Current = 88 Ma. Maximum Average Plate Current = 1.7 Ma.									
3AU6	T-5½	Pentode	7BK	3.15*	0.600	R-F Amp.	3.3	Characteristics Same as Type 6AU6. (3AU6 Designed for Series String Receivers.)									
3AV6	T-5½	Duodiode Tri.	7BT	3.15*	0.600	Det. Amp.	0.55	Characteristics Same as Type 6AV6. (3AV6 Designed for Series String Receivers.)									
3AW3	T-9	Diode	8EZ	3.15♦	0.220	Flyback H-W Rect.	Maximum Peak Inverse Volts = 30,000 Volts. Maximum Peak Plate Current = 88 Ma. Maximum Average Plate Current = 1.7 Ma.									
3B2	T-12	Diode	8GH	3.15	0.220	H-W Rect.	TV Service. Pulsed Rectifier Service. Max. Peak Inverse Volts = 35 Kv, Output = 1.1 Ma.									
3B7	Lock-in	Duotriode	7BE	2.8♦ 1.4♦	0.110 0.220	Power Amp. Oscillator	2.97	135 180	0 0	22.0 25.0	(Class AB2) (Class C)	1900 2800 mw at 25 mc, 1400 mw at 125 mc.	20	16000	1500
3BA6	T-5½	Pentode	7BK	3.15*	0.600	I-F or R-F Amplifier	3.3	Characteristics Same as Type 6BA6. (3BA6 Designed for Series String Receivers.)									
3BC5	T-5½	Pentode	7BD	3.15*	0.600	VHF Amp.	2.2	Characteristics Same as Type 6BC5. (3BC5 Designed for Series String Receivers.)									
3BE6	T-5½	Heptode	7CH	3.15*	0.600	Converter	1.1	Characteristics Same as Type 6BE6. (3BE6 Designed for Series String Receivers.)									
3BN4A	T-5½	Triode	7EG	3.0*	0.450	VHF Amp.	2.2	Characteristics Same as Type 6BN4A. (3BN4A Designed for Series String Receivers.)									
3BN6	T-5½	Gated Beam	7DF	3.15*	0.600	Quad. Det.	Characteristics Same as Type 6BN6. (3BN6 Designed for Series String Receivers.)									
3BU8 3BU8A	T-6½	Duo Pentode	9FG	3.15*	0.600	Sync. Sep.	1.1	Characteristics Same as Type 6BU8. (3BU8 Designed for Series String Receivers.)									
3BX6	T-6½	Pentode	9AQ	3.4*	0.600	VHF Amp.	2.5	Characteristics Same as Type 6BX6. (3BX6 Designed for Series String Receivers.)									
3BY6	T-5½	Heptode	7CH	3.15*	0.600	Sync. Sep.	2.2	Characteristics Same as Type 6BY6. (3BY6 Designed for Series String Receivers.)									
3BY7	T-6½	Pentode	9AQ	3.4*	0.600	VHF Amp.	2.7	100 250	1.1 2.0	57 100	5.5 10	1.6 2.5	250000 600000	5000 6000	

(1) See Frontal Section. (2) Design Maximum Values. (3) Has Special Mechanical and/or Life Characteristics. (4) Average Contact Potential Bias Developed Across Specified Grid Resistor. * Controlled Heater Warm-up Time (applies to parallel connections of types having a tapped heater.)
 † Maximum Signal. ‡ Filamentary Type. † Conversion Transconductance. † Plate to Plate. † Cathode Resistor (ohms).

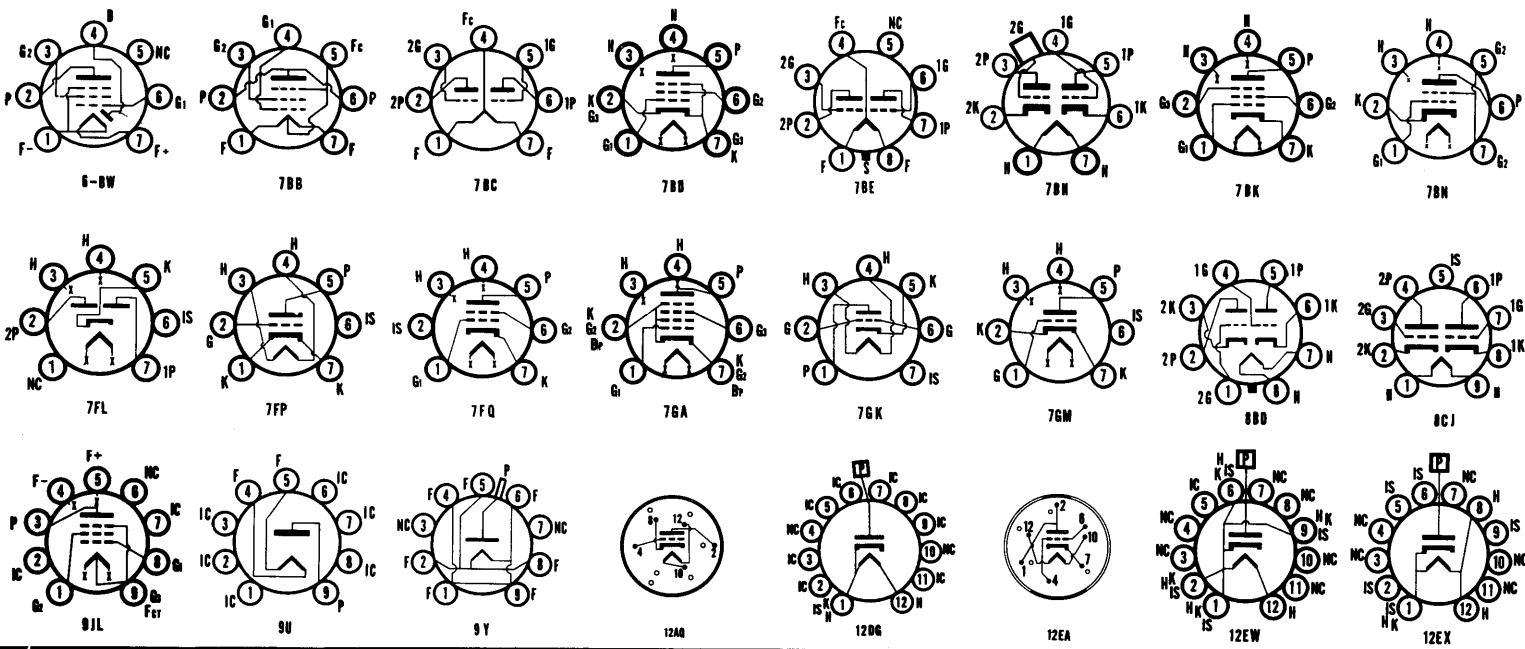

SYLVANIA TUBES

TYPE	CONSTRUCTION			EMITTER		USE	Plate Diss. Watts ²	Plate Volts	Negative Grid Volts	Screen Volts	Plate Current Ma.	Screen Current Ma.	Plate Resis. Ohms	Transconductance Micros.	Amplification Factor	Ohms Load for Stated Power Output	Power Output Milli-watts
	Bulb Size or Style ¹	Class	Basing Diag.	Volts	Amps.												
3BZ6	T-5½	Pentode	7CM	3.15*	0.600	VHF Amp.	2.3	Characteristics Same as Type 6BZ6. (3BZ6 Designed for Series String Receivers.)									
3CB6	T-5½	Pentode	7CM	3.15*	0.600	Amplifier	2.3	Characteristics Same as Type 6CB6. (3CB6 Designed for Series String Receivers.)									
3CE5	T-5½	Pentode	7BD	3.15*	0.600	VHF Amp.	2.2	Characteristics Same as Type 6CE5. (3CE5 Designed for Series String Receivers.)									
3CF6	T-5½	Pentode	7CM	3.15*	0.600	VHF Amp.	2.3	Characteristics Same as Type 6CF6. (3CF6 Designed for Series String Receivers.)									
3CS6	T-5½	Heptode	7CH	3.15*	0.600	Sync. Sep.	1.0	Characteristics Same as Type 6CS6. (3CS6 Designed for Series String Receivers.)									
3CY5	T-5½	Tetrode	7EW	2.9*	0.450	VHF Amp.	2.0	Characteristics Same as Type 6CY5. (3CY5 Designed for Series String Receivers.)									
3D6	Lock-in	Beam Pent.	6BA	2.8♠ 1.4♠	0.110 0.220	Power Amp.	4.95	150 150	4.5 20.0	90 135	10.2 23.0	1.8 6.0	(Class A) (Class C)	2400 R.F. Power Amp.	14000 at 50 mc.	600 1400	
3DG4	T-12	Duodiode	5DE Directly Heated	3.3	3.800	F-W Rect.	275 A.C. Volts Per Plate, RMS, 350 Ma. Output Current. Condensor Input to Filter. 300 Volts D.C. Output.									
3DK6	T-5½	Pentode	7CM	3.15*	0.600	VHF Amp.	2.2	Characteristics Same as Type 6DK6. (3DK6 Designed for Series String Receivers.)									
3DT6	T-5½	Gated Beam	7EN	3.15*	0.600	Quad F. M. Det.	1.65	Characteristics Same as Type 6DT6. (3DT6 Designed for Series String Receivers.)									
3DT6A	T-5½	Gated Beam	7EN	3.15*	0.600	Quad F. M. Det.	1.7	Characteristics Same as Type 6DT6A. (3DT6A Designed for Series String Receivers.)									
3DX4	T-5½	Triode	7DK	3.0*	0.450	UHF Osc.	2.2	Characteristics Same as Type 6DX4. (3DX4 Designed for Series String Receivers.)									
3DY4	T-5½	Triode	7DK	2.9*	0.300	UHF Osc.	1.5	Characteristics Same as Type 6DY4. (3DY4 Designed for Series String Receivers.)									
3DY4A	T-5½	Triode	7DK	2.9*	0.300	UHF Osc.	1.5	Characteristics Same as Type 6DY4A. (3DY4A Designed for Series String Receivers.)									
3DZ4	T-5½	Triode	7DK	2.3*	0.450	UHF Osc.	2.3	Characteristics Same as Type 6DZ4. (3DZ4 Designed for Series String Receivers.)									
3EA5	T-5½	Tetrode	7EW	2.9*	0.450	VHF Amp.	3.25	Characteristics Same as Type 6EA5. (3EA5 Designed for Series String Receivers.)									
3EH7	T-6½	Pentode	9AQ	3.4*	0.600	VHF Amp.	2.7	Characteristics Same as Type 6EH7. (3EH7 Designed for Series String Receivers.)									
3EJ7	T-6½	Pentode	9AQ	3.4*	0.600	VHF Amp.	2.7	Characteristics Same as Type 6EJ7. (3EJ7 Designed for Series String Receivers.)									
3ER5	T-5½	Triode	7FP	2.8*	0.450	VHF Amp.	2.2	Characteristics Same as Type 6ER5. (3ER5 Designed for Series String Receivers.)									
3ES5	T-5½	Triode	7FP	3.0*	0.450	VHF Amp.	2.2	Characteristics Same as Type 6ES5. (3ES5 Designed for Series String Receivers.)									
3EV5	T-5½	Tetrode	7EW	2.9*	0.450	VHF Amp.	3.25	Characteristics Same as Type 6EV5. (3EV5 Designed for Series String Receivers.)									
3FH5	T-5½	Triode	7FP	3.0*	0.450	R-F Amp.	2.2	Characteristics Same as Type 6FH5. (3FH5 Designed for Series String Receivers.)									
3FQ5	T-5½	Triode	7FP	2.8*	0.450	VHF Amp.	2.5	Characteristics Same as Type 6FQ5. (3FQ5 Designed for Series String Receivers.)									
3FQ5A	T-5½	Triode	7FP	2.8*	0.450	VHF Amp.	2.5	Characteristics Same as Type 6FQ5A. (3FQ5A Designed for Series String Receivers.)									
3FS5	T-5½	Shadow Grid Beam Pentode	7GA	2.9*	0.450	VHF Amp.	3.2	Characteristics Same as Type 6FS5. (3FS5 Designed for Series String Receivers.)									
3FW7	T-3	Twin Triode	8LM	3.5*	0.600	VHF Osc.-Mixer	Characteristics Same as Type 6FW7. (3FW7 Designed for Series String Receivers.)									
3FX7	T-3	Twin Triode	8LK	3.5*	0.600	VHF Amp.	1.7	Characteristics Same as Type 6FX7. (3FX7 Designed for Series String Receivers.)									
3FY5	T-5½	Triode	7FP	3.1*	0.450	VHF Amp.	2.2	Characteristics Same as Type 6FY5. (3FY5 Designed for Series String Receivers.)									
3GK5	T-5½	Triode	7FP	2.8*	0.450	VHF Amp.	2.5	Characteristics Same as Type 6GK5. (3GK5 Designed for Series String Receivers.)									
3GS8	T-6½	Duo Pent.	9LW	3.15*	0.600	Sync. Sep.	1.1	Characteristics Same as Type 6GS8. (3GS8 Designed for Series String Receivers.)									
3GU5	T-5½	Pentode	7GA	3.1*	0.450	VHF Amp.	3.0	Characteristics Same as Type 6GU5. (3GU5 Designed for Series String Receivers.)									
3GW5	T-5½	Triode	7GK	3.0*	0.450	VHF Amp.	2.5	Characteristics Same as Type 6GW5. (3GW5 Designed for Series String Receivers.)									
3HA5	T-5½	Triode	7GM	2.7*	0.450	VHF Amp.	2.6	Characteristics Same as Type 6HA5. (3HA5 Designed for Series String Receivers.)									
3HK5	T-5½	Triode	7GM	2.9*	0.450	VHF Amp.	2.3	Characteristics Same as Type 6HK5. (3HK5 Designed for Series String Receivers.)									
3HM5	T-5½	Triode	7GM	2.9*	0.450	VHF Amp.	2.2	Characteristics Same as Type 6HM5. (3HM5 Designed for Series String Receivers.)									
3HM6	T-6½	Pentode	9PM	3.15*	0.600	T.V. I-F Amp.	2.5	Characteristics Same as Type 6HM6. (3HM6 Designed for Series String Receivers.)									
3HS8	T-6½	Twin Pent.	9LW	3.15*	0.600	AGC/Sync. Amplifier	1.1	Characteristics Same as Type 6HS8. (3HS8 Designed for Series String Receivers.)									
3HT6	T-6½	Pentode	9PM	3.15*	0.600	T.V. I-F Amp.	2.5	Characteristics Same as Type 6HT6. (3HT6 Designed for Series String Receivers.)									
3JC6	T-6½	Pentode	9PM	3.5*	0.600	T.V. I-F Amp.	2.5	Characteristics Same as Type 6JC6. (3JC6 Designed for Series String Receivers.)									
3JD6	T-6½	Pentode	9PM	3.5*	0.600	T.V. I-F Amp.	2.5	Characteristics Same as Type 6JD6. (3JD6 Designed for Series String Receivers.)									
3KF8	T-6½	Twin Pentode	9FG	3.15*	0.600	Sync. AGC	1.1	Characteristics Same as Type 6KF8. (3KF8 Designed for Series String Receivers.)									
3Q4	T-5½	Power Pent.	7BA	1.4♠ 2.8♠	0.100 0.050	Power Amp.	85 90 90	5.0 4.5 4.5	85 90 90	6.9 9.5 7.7	1.5 2.1 1.7	120000 100000 120000	1975 2150 2000	10000 10000 10000	250 270 240

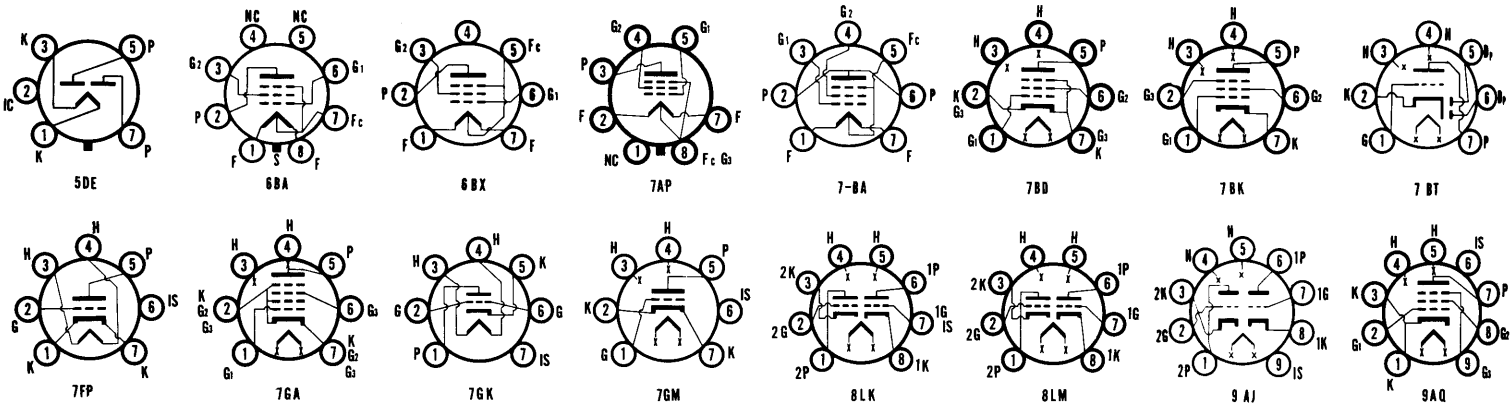

AVERAGE CHARACTERISTICS

TYPE	CONSTRUCTION			EMITTER		USE	Plate Diss. Watts ²	Plate Volts	Negative Grid Volts	Screen Volts	Plate Current Ma.	Screen Current Ma.	Plate Resis. Ohms	Transconductance Micros.	Amplification Factor	Ohms Load for Stated Power Output	Power Output Milliwatts
	Bulb Size or Style ¹	Class	Basing Diag.	Volts	Amps.												
3Q5GT	T-9	Beam Pent.	7AP	1.4 2.8	0.100 0.050	Power Amp.	90	4.5	90	9.5	1.3	90000	2200	8000	270	230	
3S4	T-5½	Power Pent.	7BA	1.4 2.8	0.100 0.050	Power Amp.	90	7.0	67.5	7.4	1.4	100000	1575	8000	270	235	
3V4	T-5½	Power Pent.	6BX	1.4 2.8	0.100 0.050	Power Amp.	Characteristics Same as Type 3Q4.										
3Z4	T-5½	Power Pent.	7BA	1.4 2.8	0.050 0.025	Power Amp.	67.5	7.0	67.5	6.5	1.3	100000	1450	8000	210		
4AU6	T-5½	Pentode	7BK	4.2*	0.450	R-F Amp.	3.3	Characteristics Same as Type 6AU6. (4AU6 Designed for Series String Receivers.)									
4AV6	T-5½	Duodiode Tri.	7BT	4.2*	0.450	Det. Amp.	.55	Characteristics Same as Type 6AV6. (4AV6 Designed for Series String Receivers.)									
4BA6	T-5½	Pentode	7BK	4.2*	0.450	R-F Amp.	3.3	Characteristics Same as Type 6BA6. (4BA6 Designed for Series String Receivers.)									
4BC5	T-5½	Pentode	7BD	4.2*	0.450	VHF Amp.	2.2	Characteristics Same as Type 6BC5. (4BC5 Designed for Series String Receivers.)									
4BC8	T-6½	Duotriode	9AJ	4.2*	0.600	VHF Amp.	2.2	Characteristics Same as Type 6BC8. (4BC8 Designed for Series String Receivers.)									
4BE6	T-5½	Heptode	7CH	4.2*	0.450	Converter	1.1	Characteristics Same as Type 6BE6. (4BE6 Designed for Series String Receivers.)									
4BL8	T-6½	Tri. Pentode	9DC	4.6*	0.600	VHF Osc. VHF Amp.	1.6 1.8	Characteristics Same as Type 6BL8. (4 BL8 Designed for Series String Receivers.)									
4BN4	T-5½	Triode	7EG	4.2	0.300	VHF Amp.	2.42	Characteristics Same as Type 6BN4.									
4BN6	T-5½	Gated Beam	7DF	4.2*	0.450	Quad. F. M. Det.	3.3	Characteristics Same as Type 6BN6. (4BN6 Designed for Series String Receivers.)									
4BQ7A	T-6½	Duotriode	9AJ	4.2*	0.600	VHF Amp.	2.2	Characteristics Same as Type 6BQ7A. (4BQ7A Designed for Series String Receivers.)									
4BS8	T-6½	Duotriode	9AJ	4.5*	0.600	VHF Amp.	2.2	Characteristics Same as Type 6BS8. (4BS8 Designed for Series String Receivers.)									
4BX8	T-6½	Duotriode	9AJ	4.5*	0.600	VHF Amp.	2.0	Characteristics Same as Type 6BX8. (4BX8 Designed for Series String Receivers.)									
4BZ6	T-5½	Pentode	7CM	4.2*	0.450	R-F Amp.	2.3	Characteristics Same as Type 6BZ6. (4BZ6 Designed for Series String Receivers.)									
4BZ7	T-6½	Duotriode	9AJ	4.2*	0.600	VHF Amp.	2.2	Characteristics Same as Type 6BZ7. (4BZ7 Designed for Series String Receivers.)									
4BZ8	T-6½	Duotriode	9AJ	4.2*	0.600	VHF Amp.	2.4	Characteristics Same as Type 6BZ8. (4BZ8 Designed for Series String Receivers.)									
4CB6	T-5½	Pentode	7CM	4.2*	0.450	VHF Amp.	2.3	Characteristics Same as Type 6CB6. (4CB6 Designed for Series String Receivers.)									
4CE5	T-5½	Pentode	7BD	4.2*	0.450	VHF Amp.	2.2	Characteristics Same as Type 6CE5. (4CE5 Designed for Series String Receivers.)									
4CM4	T-6½	Triode	9KG	3.8	0.300	VHF Amp.	1.1	Characteristics Same as Type 6CM4. (4CM4 Designed for Series String Receivers.)									
4CS6	T-5½	Dual Control Heptode	7CH	4.2	0.450	Sync. Sep.	1.1	Characteristics Same as Type 6CS6. (4CS6 Designed for Series String Receivers.)									
4CX7	T-6½	Duotriode	9FC	4.2*	0.600	Amplifier	2.2	Characteristics Same as Type 6CX7. (4CX7 Designed for Series String Receivers.)									
4CY5	T-5½	Tetrode	7EW	4.5*	0.300	VHF Amp.	2.2	Characteristics Same as Type 6CY5. (4CY5 Designed for Series String Receivers.)									
4DE6	T-5½	Pentode	7CM	4.2*	0.450	VHF Amp.	2.3	Characteristics Same as Type 6DE6. (4DE6 Designed for Series String Receivers.)									
4DK6	T-5½	Pentode	7CM	4.2*	0.450	VHF Amp.	2.2	Characteristics Same as Type 6DK6. (4DK6 Designed for Series String Receivers.)									
4DT6	T-5½	Gated Beam	7EN	4.2*	0.450	Quad. F. M. Det.	1.65	Characteristics Same as Type 6DT6. (4DT6 Designed for Series String Receivers.)									
4DT6A	T-5½	Gated Beam	7EN	4.2*	0.450	Quad. F. M. Det.	1.7	Characteristics Same as Type 6DT6A. (4DT6A Designed for Series String Receivers.)									
4EH7	T-6½	Pentode	9AQ	4.4*	0.450	VHF Amp.	2.7	Characteristics Same as Type 6EH7. (4EH7 Designed for Series String Receivers.)									
4EJ7	T-6½	Pentode	9AQ	4.4*	0.450	VHF Amp.	2.7	Characteristics Same as Type 6EJ7. (4EJ7 Designed for Series String Receivers.)									
4ES8	T-6½	Duotriode	9AJ	4.0	0.600	VHF Amp.	1.98	Characteristics Same as Type 6ES8. (4ES8 Designed for Series String Receivers.)									
4EW6	T-5½	Pentode	7CM	4.2*	0.600	VHF Amp.	3.1	Characteristics Same as Type 6EW6. (4EW6 Designed for Series String Receivers.)									
4GK5	T-5½	Triode	7FP	4.0*	0.300	VHF Amp.	2.5	Characteristics Same as Type 6GK5. (4GK5 Designed for Series String Receivers.)									
4GM6	T-5½	Pentode	7CM	4.2*	0.600	VHF Amp.	3.1	Characteristics Same as Type 6GM6. (4GM6 Designed for Series String Receivers.)									
4GS8	T-6½	Duo. Pent.	9LW	4.2*	0.450	Sync. Sep.	1.1	Characteristics Same as Type 6GS8. (4GS8 Designed for Series String Receivers.)									
4GW5	T-5½	Triode	7GK	4.2*	0.300	VHF Amp.	2.5	Characteristics Same as Type 6GW5. (4GW5 Designed for Series String Receivers.)									
4GZ5	T-5½	Beam Pent.	7CV	4.0*	0.600	S.T.A1 Amp.	4.8	250	270 ^m	250	16	2.7	150000	8400	15000	1.1	
								250	270 ^m	250	16	2.7	15000	1.8	

Bypassed Cathode Resistor P.O. = 1.1 at 10% Dist. Unbypassed RK P.O. = 1.8 at 10%.

- (1) See Frontal Section. (2) Design Maximum Values. (3) Has Special Mechanical and/or Life Characteristics. (4) Average Contact Potential Bias Developed Across Specified Grid Resistor. * Controlled Heater Warm-up Time (applies to parallel connections of types having a tapped heater.)
 † Maximum Signal. ‡ Filamentary Type. § Conversion Transconductance. ¶ Plate to Plate. ■ Cathode Resistor (ohms).

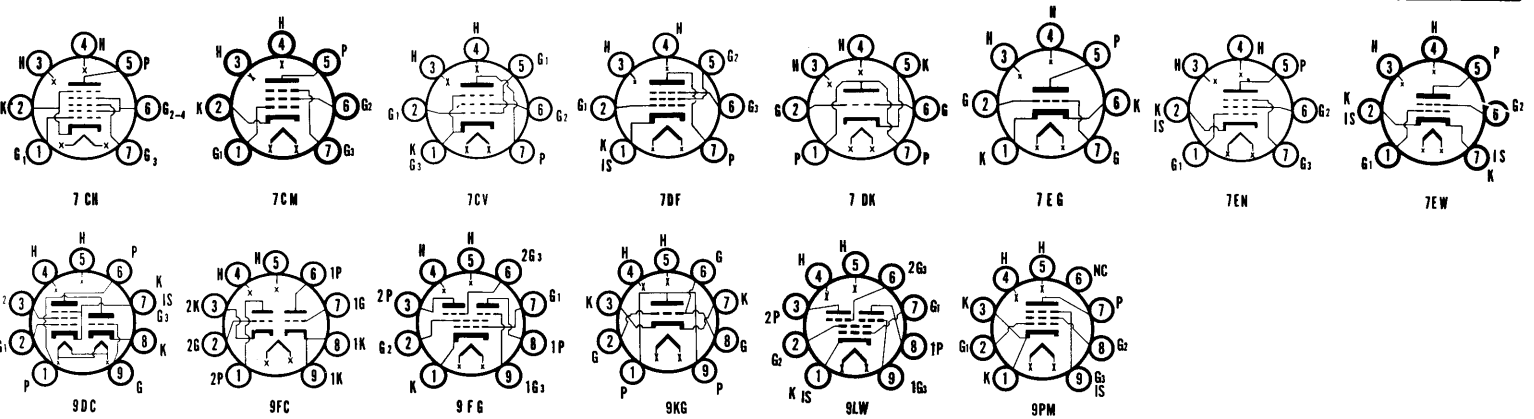

SYLVANIA TUBES

TYPE	CONSTRUCTION			EMITTER		USE	Plate Diss. Watts ²	Plate Volts	Negative Grid Volts	Screen Volts	Plate Current Ma.	Screen Current Ma.	Plate Resis. Ohms	Transconductance Micros.	Amplification Factor	Ohms Load for Stated Power Output	Power Output Milliwatts
	Bulb Size or Style ¹	Class	Basing Diag.	Volts	Amps.												
4HA5	T-5½	Triode	7GM	3.9*	0.300	VHF Amp.	2.6	Characteristics Same as Type 6HA5. (4HA5 Designed for Series String Receivers.)									
4HA7	Comp. T-9	Double Tri.	12FQ	4.2*	0.600	Phase Inverter Voltage Amp.	2.75 0.30	250 250	8.5 2.0	10.5 1.2	7700 62500	2200 1600	17 100
4HG8	T-6½	Tri. Pentode	9MP	4.5*	0.600	VHF Mixer	2.0	Characteristics Same as Type 6HG8. (4HG8 Designed for Series String Receivers.)									
4HK5	T-5½	Triode	7GM	4.0*	0.300	VHF Amp.	2.3	Characteristics Same as Type 6HK5. (4HK5 Designed for Series String Receivers.)									
4HM5	T-5½	Triode	7GM	4.0*	0.300	VHF Amp.	2.2	Characteristics Same as Type 6HM5. (4HM5 Designed for Series String Receivers.)									
4HM6	T-6½	Pentode	9PM	4.2*	0.450	T.V. I-F Amp.	2.5	Characteristics Same as Type 6HM6. (4HM6 Designed for Series String Receivers.)									
4HR8	T-6½	Pentode	9BJ	4.5*	0.300	Amplifier	1.0	250	2	140	3	0.6	2500	2000	38
4HS8	T-6½	Twin Pentode	9LW	4.2*	0.450	AGC/Sync. Amplifier	1.1	Characteristics Same as Type 6HS8. (4HS8 Designed for Series String Receivers.)									
4HT6	T-6½	Pentode	9PM	4.2*	0.450	T.V. I-F Amp.	2.5	Characteristics Same as Type 6HT6. (4HT6 Designed for Series String Receivers.)									
4JC6	T-6½	Pentode	9PM	4.5*	0.450	T.V. I-F Amp.	2.5	Characteristics Same as Type 6JC6. (4JC6 Designed for Series String Receivers.)									
4JD6	T-6½	Pentode	9PM	4.5*	0.450	T.V. I-F Amp.	2.5	Characteristics Same as Type 6JD6. (4JD6 Designed for Series String Receivers.)									
4JK6	T-5½	Pentode	7CM	3.7*	0.600	T.V. I-F Amp.	2.5	Characteristics Same as Type 6JK6. (4JK6 Designed for Series String Receivers.)									
4JL6	T-5½	Pentode	7CM	3.7*	0.600	T.V. I-F Amp.	2.5	Characteristics Same as Type 6JL6. (4JL6 Designed for Series String Receivers.)									
4KF8	T-6½	Twin-Pentode	9PG	4.2*	0.450	Sync. AGC	1.1	Characteristics Same as Type 6KF8. (4KF8 Designed for Series String Receivers.)									
4KN8	T-6½	Twin Triode	9AJ	4.2*	0.600	VHF Amp.	2.2	Characteristics Same as Type 6KN8. (4KN8 Designed for Series String Receivers.)									
5AF4A	T-5½	Triode	7DK	4.7*	0.300	UHF Osc.	2.5	Characteristics Same as Type 6AF4A. (5AF4A Designed for Series String Receivers.)									
5AM8	T-6½	Diode Pent.	9CY	4.7*	0.600	Amp. Det.	3.2	Characteristics Same as Type 6AM8. (5AM8 Designed for Series String Receivers.)									
5AN8	T-6½	Tri. Pentode	9DA	4.7*	0.600	Tri. Amp. Pent. Amp.	2.86 2.2	Characteristics Same as Type 6AN8. (5AN8 Designed for Series String Receivers.)									
5AQ5	T-5½	Beam Pent.	7BZ	4.7*	0.600	Power Amp.	13.2	Characteristics Same as Type 6AQ5. (5AQ5 Designed for Series String Receivers.)									
5AR4	T-11	Duodiode	5L	5.0♠	1.900	F-W Rect.	450 A.C. Volts Per Plate, RMS, 250 Ma. Output Current. Condenser Input to Filter.									
5AS4	ST-16	Duodiode	5T	5.0	3.000	Full-Wave Rectifier	Characteristics Same as Type 5U4GB.									
5AS4A	T-12	Duodiode	5T	5.0	3.000	Full-Wave Rectifier	Characteristics Same as Type 5U4GB.									
5AS8	T-6½	Diode Pent.	9DS	4.7*	0.600	Det. Amp.	2.75	Characteristics Same as Type 6AS8. (5AS8 Designed for Series String Receivers.)									
5AT4	ST-16	Duodiode	5L	5.0♠	5.500	F-W Rect.	550 A.C. Volts Per Plate, RMS, 800 Ma. Output Current. Condenser Input to Filter.									
5AT8	T-6½	Tri. Pentode	9DW	4.7*	0.600	Tri. Osc. Converter	1.7 2.3	Characteristics Same as Type 6AT8. (5AT8 Designed for Series String Receivers.)									
5AU4	T-12	Duodiode	5T	4.5♠	3.75	F-W Rect.	400 A.C. Volts Per Plate, 325 Ma. Output Current. Condenser Input to Filter. 500 A.C. Volts Per Plate, 325 Ma. Output Current. Choke Input to Filter.									
5AV8	T-6½	Tri. Pentode	9DZ	4.7*	0.600	Tri. Amp. Pent. Amp.	2.75 2.2	Characteristics Same as Type 6AN8. (5AV8 Designed for Series String Receivers.)									
5AW4	T-12	Duodiode	5T	5.0♠	4.000	F-W Rect.	450 A.C. Volts Per Plate, RMS, 250 Ma. Output Current. Condenser Input to Filter. Peak Current = 750 Ma. Per Plate.									
5AX4GT	T-9	Duodiode	5T	5.0♠	2.250	F-W Rect.	350 A.C. Volts Per Plate, RMS, 150 Ma. D.C. Output Current. Condenser Input to Filter. 500 A.C. Volts Per Plate, RMS, 150 Ma. D.C. Output Current. Choke Input to Filter.									
5AZ3	Comp. T-12	Duodiode	12BR	5.0♠	3.000	F-W Rect.	300 A.C. Volts Per Plate, RMS, 300 Ma. Output Current. Condenser Input to Filter. 450 A.C. Volts Per Plate, RMS, 275 Ma. Output Current. Condenser Input to Filter.									
5AZ4	Lock-in	Duodiode	5T	5.0♠	2.000	F-W Rect.	Characteristics Same as Type 5Y3GT.									
5B8	T-6½	Tri. Pentode	9EC	4.7*	0.600	Tri. Amp. Pent. Amp.	2.2 2.75	200 200	6 180 150	13 9.5 2.8	5750 300000	3300 6200	19
5BC3	Novar T-12	Duodiode	9QJ	5.0♠	3.000	F-W Rect.	450 A.C. Volts Per Plate, RMS, 275 Ma. Output Current. Condenser Input to Filter.									
5BE8	T-6½	Tri. Pentode	9EG	4.7*	0.600	Tri. Osc. Converter	2.75 3.0	Characteristics Same as Type 6U8. (5BE8 Designed for Series String Receivers.)									
5BK7A	T-6½	Duotriode	9AJ	4.7*	0.600	VHF Amp.	2.97	Characteristics Same as Type 6BK7A. (5BK7A Designed for Series String Receivers.)									
5BQ7A	T-6½	Duotriode	9AJ	5.6*	0.450	VHF Amp.	2.2	Characteristics Same as Type 6BQ7A. (5BQ7A Designed for Series String Receivers.)									
5BR8	T-6½	Triode Pentode	9FA	4.7*	0.600	Osc. Mixer	2.97 3.0	Characteristics Same as Type 6BR8. (5BR8 Designed for Series String Receivers.)									
5BT8	T-6½	Duodi. Pent.	9FE	4.7*	0.600	Amp. Det.	2.2	Characteristics Same as Type 6BT8. (5BT8 Designed for Series Receivers.)									

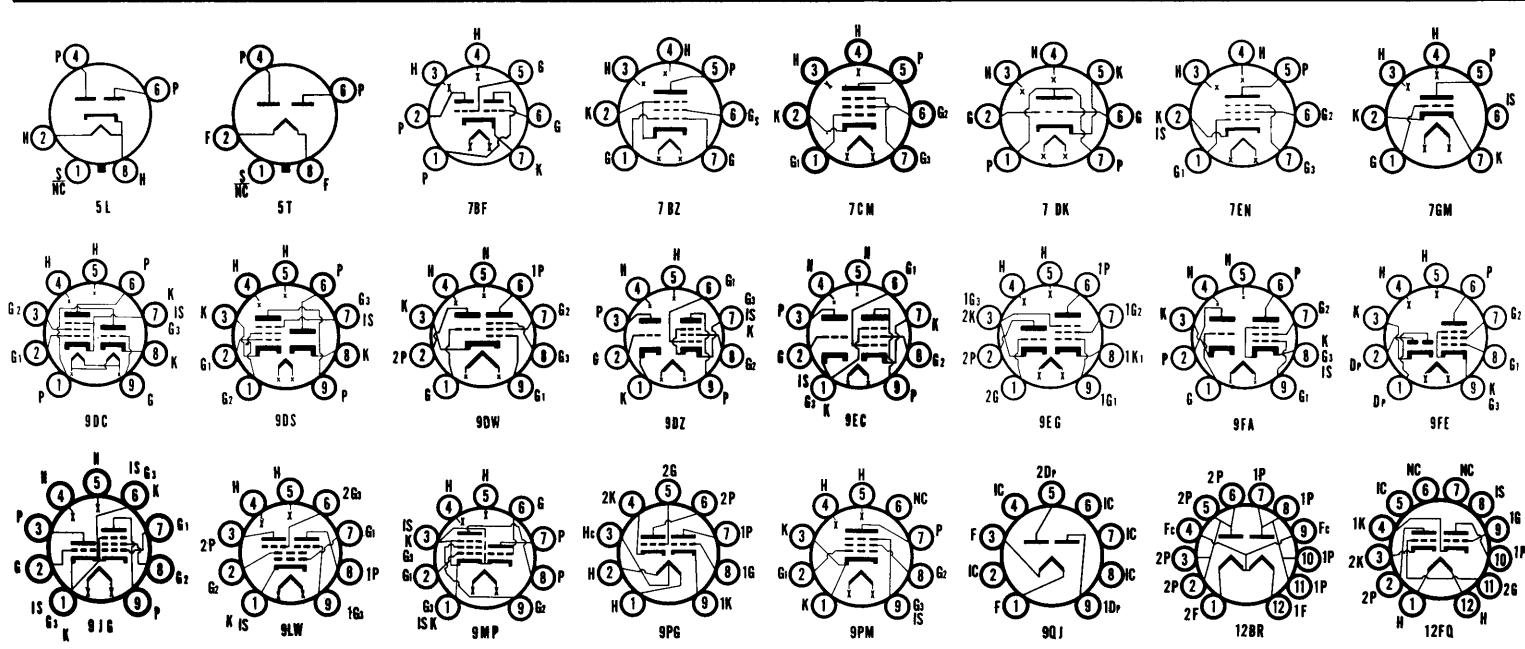

AVERAGE CHARACTERISTICS

TYPE	CONSTRUCTION			EMITTER		USE	Plate Diss. Watts ²	Plate Volts	Negative Grid Volts	Screen Volts	Plate Current Ma.	Screen Current Ma.	Plate Resis. Ohms	Transconductance Micros.	Amplification Factor	Ohms Load for Stated Power Output	Power Output Milliwatts
	Bulb Size or Style ¹	Class	Basing Diag.	Volts	Amps.												
5BW8	T-6½	Duodi. Pent.	9HK	4.7*	0.600	R-F or I-F Amplifier	3.0	Characteristics Same as Type 6BW8. (5BW8 Designed for Series String Receivers.)									
5BZ7	T-6½	Duotriode	9AJ	5.6*	0.450	VHF Amp.	2.2	Characteristics Same as Type 6BZ7. (5BZ7 Designed for Series String Receivers.)									
5CG4	T-9	Duotriode	5L	5.0	2.0	F-W Rect.	...	350 A.C. Volts Per Plate, RMS, 125 Ma. Max. D.C. Output Current.									
5CG8	T-6½	Tri. Pentode	9GF	4.7*	0.600	Osc. Mixer	1.7 2.3	Characteristics Same as Type 6CG8. (5CG8 Designed for Series String Receivers.)									
5CL8	T-6½	Tri. Tetrode	9FX	4.7*	0.600	Osc. Mixer	2.97 3.0	Characteristics Same as Type 6CL8. (5CL8 Designed for Series String Receivers.)									
5CL8A	T-6½	Tri. Tetrode	9FX	4.7*	0.600	VHF Osc. VHF Amp.	2.97 3.0	Characteristics Same as Type 6CL8A. (5CL8A Designed for Series String Receivers.)									
5CM6	T-6½	Beam Pent.	9CK	4.7*	0.600	Power Amp	13.2	Characteristics Same as Type 6CM6. (5CM6 Designed for Series String Receivers.)									
5CM8	T-6½	Tri. Pentode	9FZ	4.7*	0.600	Class A1 Amp	1.1 2.2	Characteristics Same as Type 6CM8. (5CM8 Designed for Series String Receivers.)									
5CQ8	T-6½	Tri. Tetrode	9GE	4.7*	0.600	VHF Tri. Osc. VHF Pent. A.	2.79 3.0	Characteristics Same as Type 6CQ8. (5CQ8 Designed for Series String Receivers.)									
5CR8	T-6½	Tri. Pentode	9GJ	4.7*	0.600	Tri. Amp. Pent. Amp.	2.75 2.3	Characteristics Same as Type 6CR8. (5CR8 Designed for Series String Receivers.)									
5CU4	T-12	Duotriode	8KD	5.0†	3.300	H-W Rect.	...	260 Volts A.C. Per Plate, RMS, 385 Ma. Output Current. Condenser Input to Filter.									
5CZ5	T-6½	Beam Pent.	9HN	4.7*	0.600	Vert. Defl. Amplifier	13.2	Characteristics Same as Type 6CZ5. (5CZ5 Designed for Series String Receivers.)									
5DH8	T-6½	Tri. Pentode	9EG	5.2*	0.600	Vert. Osc. Video Amp.	2.0 2.2	250 125	390 [■] 56 [■]	...	7.3 13.5	...	12000 150000	4400 8600	53
5DJ4	T-12	Duotriode	8KS	5.0†	3.000	F-W Rect.	...	450 A.C. Volts Per Plate, RMS, 275 Ma. Output Current. Condenser Input to Filter.									
5EA8	T-6½	Tri. Pentode	9AE	4.7*	0.600	Tri. VHF Amp. Pent VHF Amp.	3.0 3.1	Characteristics Same as Type 6EA8. (5EA8 Designed for Series String Receivers.)									
5EH8	T-6½	Tri. Pentode	9JG	4.7*	0.600	VHF Osc. VHF Amp.	2.75 3.0	Characteristics Same as Type 6EH8. (5EH8 Designed for Series String Receivers.)									
5ES8	T-6½	Duotriode	9AJ	5.6*	0.450	VHF Amp.	1.8	90	1.4	...	15	...	2500	12500
5EU8	T-6½	Tri. Pentode	9JF	4.7*	0.600	VHF Osc. VHF Amp.	3.1	Characteristics Same as Type 6EU8. (5EU8 Designed for Series String Receivers.)									
5EW6	T-5½	Pentode	7CM	5.6*	0.450	VHF Amp.	3.1	Characteristics Same as Type 6EW6. (5EW6 Designed for Series String Receivers.)									
5FG7	T-6½	Tri. Pentode	9GF	4.7*	0.600	VHF Osc./Mixer	2.5 3.0	125 125	1.0 1.0	...	13 11	...	4 180000	7500 6000	43
5FV8	T-6½	Tri. Pentode	9FA	4.7*	0.600	Vert. Osc. VHF Amp.	2.0 2.3	Characteristics Same as Type 6FV8. (5FV8 Designed for Series String Receivers.)									
5GH8	T-6½	Tri. Pentode	9AE	4.7*	0.600	Tri. Gen. Pur. Pentode Horiz. Osc.	2.5 2.5	Characteristics Same as Type 6GH8. (5GH8 Designed for Series String Receivers.)									
5GM6	T-5½	Pentode	7CM	5.6*	0.450	VHF Amp.	3.1	Characteristics Same as Type 6GM6. (5GM6 Designed for Series String Receivers.)									
5GX6	T-5½	Pentode	7EN	4.7*	0.600	Dual Control	1.7	Characteristics Same as Type 6GX6. (5GX6 Designed for Series String Receivers.)									
5HG8	T-6½	Tri. Pentode	9MP	5.3*	0.450	VHF Mixer	2.0	Characteristics Same as Type 6HG8. (5HG8 Designed for Series String Receivers.)									
5J6	T-5½	Duotriode	7BF	4.7*	0.600	R-F Amp. Osc. Amp.	1.65	Characteristics Same as Type 6J6. (5J6 Designed for Series String Receivers.)									
5JK6	T-5½	Pentode	7CM	4.9*	0.450	T.V. I-F Amp.	2.5	Characteristics Same as Type 6JK6. (5JK6 Designed for Series String Receivers.)									
5JL6	T-5½	Pentode	7CM	4.9*	0.450	T.V. I-F Amp.	2.5	Characteristics Same as Type 6JL6. (5JL6 Designed for Series String Receivers.)									
5KD8	T-6½	Tri. Pentode	9AE	5.6*	0.450	VHF Osc.-Mixer	2.5 3.0	Characteristics Same as Type 6KD8. (5KD8 Designed for Series String Receivers.)									
5KE8	T-6½	Tri. Pentode	9DC	5.6*	0.450	VHF Osc.-Mixer	2.0 2.0	Characteristics Same as Type 6KE8. (5KE8 Designed for Series String Receivers.)									

(1) See Frontal Section.

(3) Has Special Mechanical and/or Life Characteristics.

Controlled Heater Warm-up Time (applies to parallel connections of types having a tapped heater.)

(2) Design Maximum Values.

(4) Average Contact Potential Bias Developed Across Specified Grid Resistor.

† Maximum Signal.

♦ Filamentary Type.

* Conversion Transconductance.

‡ Plate to Plate.

■ Cathode Resistor (ohms).

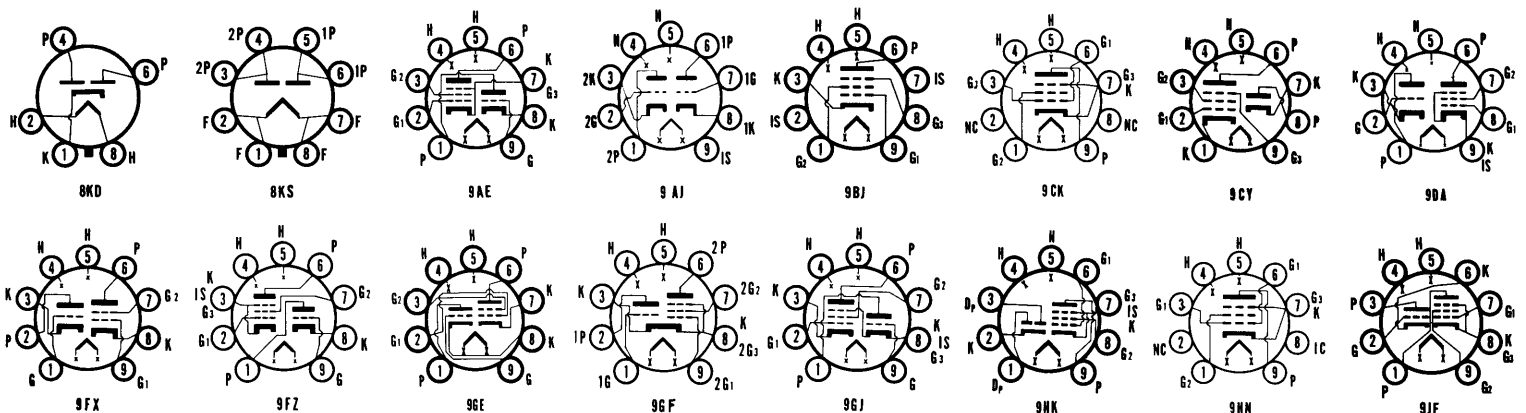

SYLVANIA TUBES

TYPE	CONSTRUCTION			EMITTER		USE	Plate Diss. Watts ²	Plate Volts	Negative Grid Volts	Screen Volts	Plate Current Ma.	Screen Current Ma.	Plate Resis. Ohms	Trans-conductance Micros.	Amplification Factor	Ohms Load for Stated Power Output	Power Output Milli-watts
	Bulb Size or Style ¹	Class	Basing Diag.	Volts	Amps.												
5R4GY 5R4GYA 5R4GYB	ST-16 T-12	Duodiode	5T	5.0	2.000	F-W Rect.	900 Volts, RMS Per Plate, 150 Ma. D.C. Output.	Condenser Input to Filter. Choke Input to Filter.								
5T4	Metal	Duodiode	5T	5.0	2.000	Rectifier	450 A.C. Volts Per Plate, RMS, 225 Ma. Output Current.	Condenser Input to Filter. Choke Input to Filter.								
5T8	T-6½	Triple Dio. Tri.	9E	4.7*	0.600	Det. Amp.	1.1	Characteristics Same as Type 6T8 (5T8 Designed for Series String Receivers.)									
5U4G	ST-16	Duodiode	5T	5.0	3.000	F-W Rect.	450 A.C. Volts Per Plate, RMS, 225 Ma. Output Current.	Condenser Input to Filter.								
5U4GA	T-11	Duodiode	5T	5.0	3.000	F-W Rect.	450 A.C. Volts Per Plate, RMS, 250 Ma. Output Current.	Condenser Input to Filter. Peak Current = 900 Ma. Per Plate.								
5U4GB	T-12	Duodiode	5T	5.0	3.000	F-W Rect.	450 A.C. Volts Per Plate RMS, 275 Ma. Output Current.	Condenser Input to Filter. Peak Current = 1 Amp. Per Plate.								
5U4WG(3)	T-12	Duodiode	5T	5.0	3.000	F-W Rect.	Characteristics Same as Type 5U4G.									
5U8	T-6½	Tri. Pentode	9AE	4.7*	0.600	VHF Osc. VHF Mixer	2.5 3.0	Characteristics Same as Type 6U8. (5U8 Designed for Series String Receivers.)									
5V3	T-12	Duodiode	5T	5.0	3.800	F-W Rect.	425 A.C. Volts Per Plate, RMS, 350 Ma. Output Current.	Condenser Input to Filter. Choke Input to Filter.								
5V3A	T-12	Duodiode	5T	5.0	3.000	F-W Rect.	425 A.C. Volts Per Plate, RMS, 350 Ma. Output Current.	Condenser Input to Filter. Choke Input to Filter.								
5V4G	ST-14	Duodiode	5L	5.0	2.000	F-W Rect.	375 A.C. Volts Per Plate, RMS, 175 Ma. Output Current.	Condenser Input to Filter.								
5V4GA	T-12	Duodiode	5L	5.0	2.000	F-W Rect.	375 A.C. Volts Per Plate, RMS, 175 Ma. Output Current.	Condenser Input to Filter. Peak Current = 525 Ma. per Plate.								
5V6GT	T-9	Beam Pent.	7S	4.7*	0.600	Power Amp.	13.2	Characteristics Same as Type 6V6GT. (5V6GT Designed for Series String Receivers.)									
5X8	T-6½	Tri. Pentode	9AK	4.7*	0.600	Oscillator Mixer	1.7 2.3	Characteristics Same as Type 6X8. (5X8 Designed for Series String Receivers.)									
5Y3GT 5Y3GA GB-5Y3WGTA(3)	T-9 T-12	Duodiode	5T	5.0	2.000	F-W Rect.	350 A.C. Volts Per Plate, RMS, 125 Ma. Output Current.	Condenser Input to Filter. Choke Input to Filter.								
5Y4GT 5Y4GA	T-9 T-12	Duodiode	5Q	5.0	2.000	F-W Rect.	Characteristics Same as Type 5Y3GT.									
5Z3	ST-16	Duodiode	4C	5.0	3.000	F-W Rect.	450 A.C. Volts Per Plate, RMS, 225 Ma. Output Current.	Condenser Input to Filter.								
5Z4 5Z4GT	Metal T-9	Duodiode	5L 5L	5.0	2.000	F-W Rect.	350 A.C. Volts Per Plate, RMS, 125 Ma. Output Current.	Condenser Input to Filter.								
6A3	ST-16	Power Triode	4D	6.3	1.000	S.T. A1 Amp. P.P.AB1 Amp. P.P.AB1 Amp.	16.5	250 325 325	45.0 68.0	60.0 80-147† 80-100† 600000	5250 (Push Pull, Fixed Bias) (Push Pull, Self Bias Resistor 850 Ohms)	4.2	2500 3000† 5000†	3200 15000 10000	
6A7	ST-12	Heptode	7C	6.3	0.300	Converter	1.1	Characteristics Same as Type 6A8G, Except Capacitances.									
6A8 6A8G 6A8GT	Metal ST-12 T-9	Heptode	8A	6.3	0.300	Converter	1.1	100 250	1.5 3.0	50 100	1.1 3.5	1.3 2.7	360000 360000	360* 550*	(Ga = 100V.) (Ga = 250 V. thru 20 K. Ohm)
6AB4	T-5½	Triode	5CE	6.3	0.150	R-F Amp.	2.75	250	200 [■]	10	10900	5500	60
6AB7	Metal	Pentode	8N	6.3	0.450	Amplifier	4.12	300	3.0	200	12.5	3.2	700000	5000	3500
6AB8	T-6½	Tri. Pentode	6AB8	6.3	0.300	A-F Amp. S.T.A1 Amp.	1.0	100 170	2.3 6.3 170	4 15 2.8	12500 150000	1400 3300	17 11000 1000
6AC7	Metal	Pentode	8N	6.3	0.450	Video Amp.	3.3	300	160 [■]	150	10.0	2.5	1.0 Meg.	9000	6750
6AD4	T-3	Triode	8DK	6.3	0.150	Osc. Amp.	0.33	100	820 [■]	1.4	35000	2000	70
6AD6G	T-9	Electron Ray	7AG	6.3	0.150	Indicator	100 (Ray Control Volts = 45 Approx. For 0° Shadow, Approx. = 23 Volts for 135° Shadow.) 150 (Ray Control Volts = 75 Approx. For 0° Shadow, Approx. = 50 Volts for 135° Shadow.)									
6AF3	T-6½	Diode	9CB	6.3	1.200	T.V. Damper	6.0	Maximum Peak Inverse Plate Voltage = 4500 Volts. Maximum D.C. Plate Current = 185 Ma.									
6AF4A 6AF4	T-5½	Triode	7DK	6.3	0.225	UHF Osc.	2.5	100	Grid Resistor = 10,000 Ohms.	17.	Plate Resistor = 220 Ohms. Grid Current = 750 μa.
6AF6G	T-9	Twin Elec. Ray	7AG	6.3	0.150	Indicator	100 (Ray Control Volts = Approx. 60 for 0° Shadow, Approx. Zero Volts for 100° Shadow.) 135 (Ray Control Volts = Approx. 81 for 0° Shadow, Approx. Zero Volts for 100° Shadow.)									

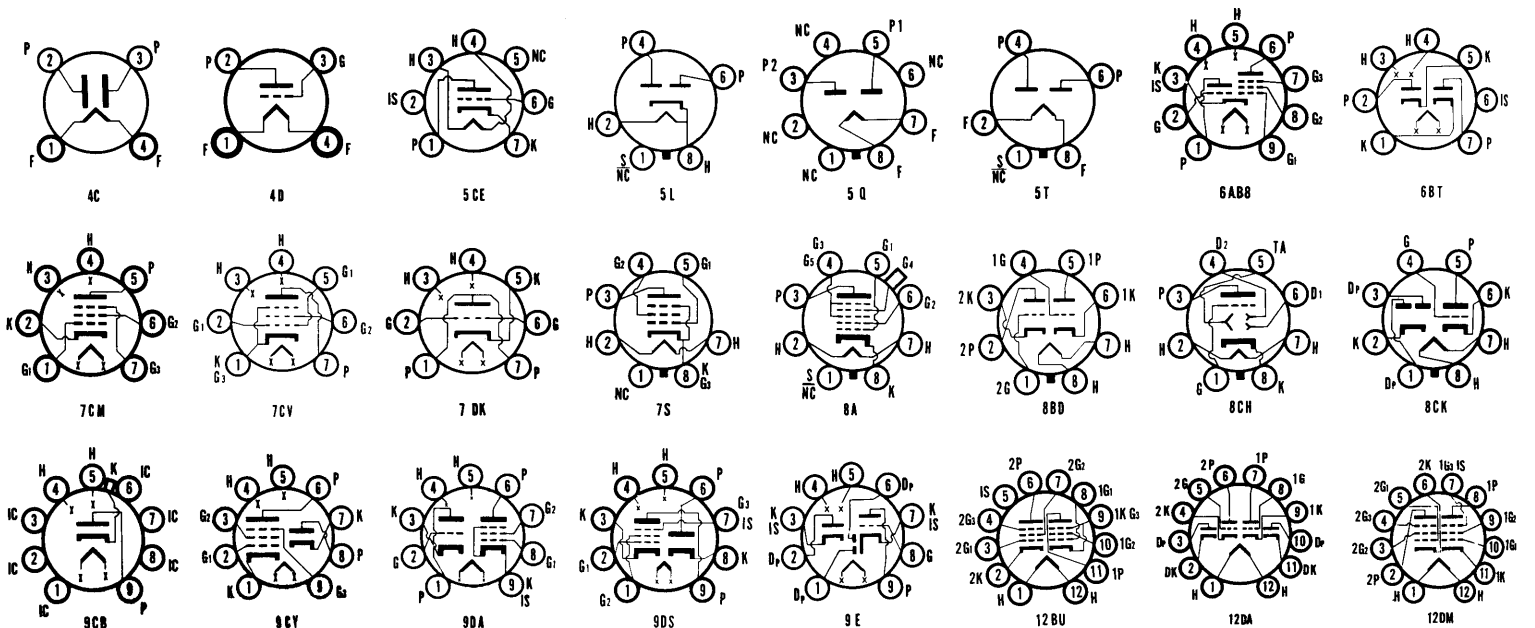

AVERAGE CHARACTERISTICS

TYPE	CONSTRUCTION			EMITTER		USE	Plate Diss. Watts ²	Plate Volts	Negative Grid Volts	Screen Volts	Plate Current Ma.	Screen Current Ma.	Plate Resis. Ohms	Transconductance Micros.	Amplification Factor	Ohms Load for Stated Power Output	Power Output Milli-watts
	Bulb Size or Style ¹	Class	Basing Diag.	Volts	Amps.												
6AF11	Comp. T-9	Pentode Duotriode	12DP	6.3	1.050	Video Amp.	5.0	250	100 [■]	150	24	4.8	68000	11000
						AGC Keyer	1.1	200	2.0	...	7.0	...	12400	5500	68
						Sync. Sep.	2.0	200	220 [■]	...	9.2	...	9400	4400	41
6AG5	T-5½	Pentode	7BD	6.3	0.300	R-F Amp.	2.2	100	180 [■]	100	4.5	1.4	600000	4500
							2.75	125	100 [■]	125	7.2	2.1	500000	5100
6AG7	Metal	Pentode	8Y	6.3	0.650	Video Amp.	9.9	300	3	150	30.0	7.0	130000	11000	...	10000	3000
6AG11	Comp. T-9	Duodiode Duotriode	12DA	6.3	0.750	FM Multiplex Service	2.0	125	1.0	...	7.5	...	8500	7800	66
6AH4GT	T-9	Triode	8EL	6.3	0.750	Defl. Amp.	8.25	250	23	...	30	...	1780	4500	8
6AH6	T-5½	Pentode	7BK	6.3	0.450	Pent. Amp.	3.52	300	160 [■]	150	10	2.5	500000	9000
						Tri. Amp.	150	160 [■]	...	12.5	...	3600	11000	40	
6AJ4	T-6½	Triode	9BX	6.3	0.225	UHF Amp.	2.2	125	68 [■]	...	16	...	4200	10000	42
6AJ5	T-5½	Pentode	7BD	6.3	0.175	R-F Amp.	1.87	28	1.0	28	2.7	1.0	100000	2500
6AK4	T-3	Triode	8DK	6.3	0.125	UHF Amp.	3.3	200	680 [■]	...	9.5	...	5300	3800	20
6AK5	T-5½	Pentode	7BD	6.3	0.175	VHF Amp.	1.87	120	180 [■]	120	7.5	2.5	300000	5000	1700
							180	180 [■]	120	7.7	2.4	500000	5100	3500	
6AK6	T-5½	Power Pent.	7BK	6.3	0.150	Power Amp.	3.0	180	9.0	180	15.0	2.5	200000	2300	...	10000	1100
6AL5	T-5½	Duodiode	6BT	6.3	0.300	Detector	...	117 A.C. Volts Per Plate, RMS, 9 Ma. Output Current.	300	Ohms Min. Effec. Plate Supply Imped
6AL7GT	T-9	Electron Ray	8CH	6.3	0.150	Indicator	...	315	Grid Volt. for Fluorescent C.O. = -7.0 (App.).	Deflection Sens = 1.0 MM. Per Volt (App.)
6AL11	Comp. T-9	Duo. Pentode	12BU	6.3	0.900	FM Detector	1.7	150	560 [■]	100	1.3	2.1	150000	G1-1000
						S.T.A1 Amp.	10	250	8.0	250	35	2.5	100000	G3-400	6500	...	5000
6AM4	T-6½	Triode	9BX	6.3	0.225	UHF Amp.	2.0	200	100 [■]	...	10	...	8700	9800	85
6AM8	T-6½	Diode Pent.	9CY	6.3	0.450	Amplifier	3.2	125	56 [■]	125	12.5	3.2	0.3 Meg.	7800
6AM8A	T-6½	Diode Pent.	9CY	6.3*	0.450	Detector	Diode Plate Voltage 10 Volts for 50 Ma. Current.	(Test Condition Only.)
6AN4	T-5½	Triode	7DK	6.3	0.225	UHF Amp.	4.4	200	100 [■]	...	13	...	7000	10000	70
6AN5	T-5½	Power Pent.	7BD	6.3	0.450	Power Amp.	4.62	120	6.0	120	35.0	12.0	12500	8000	...	2500	1300
6AN6	T-5½	Quadruple Di.	7BJ	6.3	0.200	Rectifier	...	75 Volts RMS Per Plate, 8 Ma. D-C Output Per Plate.
6AN8	T-6½	Tri. Pentode	9DA	6.3	0.450	Tri. Amp.	2.8	200	6.0	...	13.0	...	5750	3300	19
6AN8A	T-6½	Tri. Pentode	9DA	6.3*	0.450	Pent. Amp.	2.3	125	56 [■]	125	12	3.8	.017 Meg.	7800
6AQ5	T-5½	Beam Pent.	7BZ	6.3	0.450	Power Amp.	13.2	250	12.5	250	45.0	4.5	52000	4100	...	5000	4500
6AQ5A	T-5½	Beam Pent.	7BZ	6.3*	0.450	Power Amp.	180	180	8.5	180	29.0	3.0	58000	3700	...	5500	2000
6AQ6	T-5½	Duodiode Tri.	7BT	6.3	0.150	Det. Amp.	...	100	1.0	...	0.8	...	61000	1150	70
6AQ7GT	T-9	Duodiode Tri.	8CK	6.3	0.300	Det. Amp.	1.1	250	2.0	...	2.3	...	44000	1600	70
6AQ8	T-6½	Duotriode	9AJ	6.3	0.435	VHF Amp.	2.7	250	2.3	...	10	...	5900	57
6AR5	T-5½	Power Pent.	6CC	6.3	0.400	Power Amp.	9.35	250	16.5	250	34	5.7	65000	2400	...	7000	3.2
							250	18.0	250	32	5.5	68000	2300	...	7600	3.4	
6AR11	Comp. T-9	Duo. Pent.	12DM	6.3	0.800	T.V. I-F Amp.	3.1	125	56 [■]	125	11	3.5	200000	10500
6AS5	T-5½	Beam Pent.	7CV	6.3	0.800	S.T.A1 Amp.	6.0	150	8.5	110	35-36†	2-6.5†	...	5600	...	4500	2200
6AS6	T-5½	Pentode	7CM	6.3	0.175	R-F Amp.	1.87	120	2.0	120	5.2	3.5	110000	3200
6AS7G	ST-16	Duo-Power Triode	8BD	6.3	2.500	Passing Tube for VR Service	14.3	135	250 [■]	...	112	...	280	7000	2
6AS7GA	T-12	Duo-Power Triode	8BD	6.3	2.500	Passing Tube for VR Service	14.3	135	250 [■]	...	125	...	280	70000	2
6AS7GYB	T-12	Duo-Power Triode	8BD	6.3	2.500	Passing Tube for VR Service	14.3	135	250 [■]	...	125	...	280	70000	2
6AS8	T-6½	Diode Pent.	9DS	6.3*	0.450	Det. Amp.	2.75	200	180 [■]	150	9.5	3.0	300000	6200
6AS11	Comp. T-9	Duotriode Pentode	12DP	6.3	1.050	A-F Amp.	5.0	200	2.0	...	7.0	...	12400	5500	68
						Sync. Sep.	200	220 [■]	...	9.2	...	9400	4400	41	
						Video Amp.	200	68 [■]	125	24	5.2	70000	10500	

(1) See Frontal Section.
 (2) Design Maximum Values.
 † Maximum Signal.

(3) Has Special Mechanical and/or Life Characteristics.
 (4) Average Contact Potential Bias Developed Across Specified Grid Resistor.
 † Filamentary Type.

* Controlled Heater Warm-up Time (applies to parallel connections of types having a tapped heater.)
 † Plate to Plate.
 ■ Cathode Resistor (ohms).

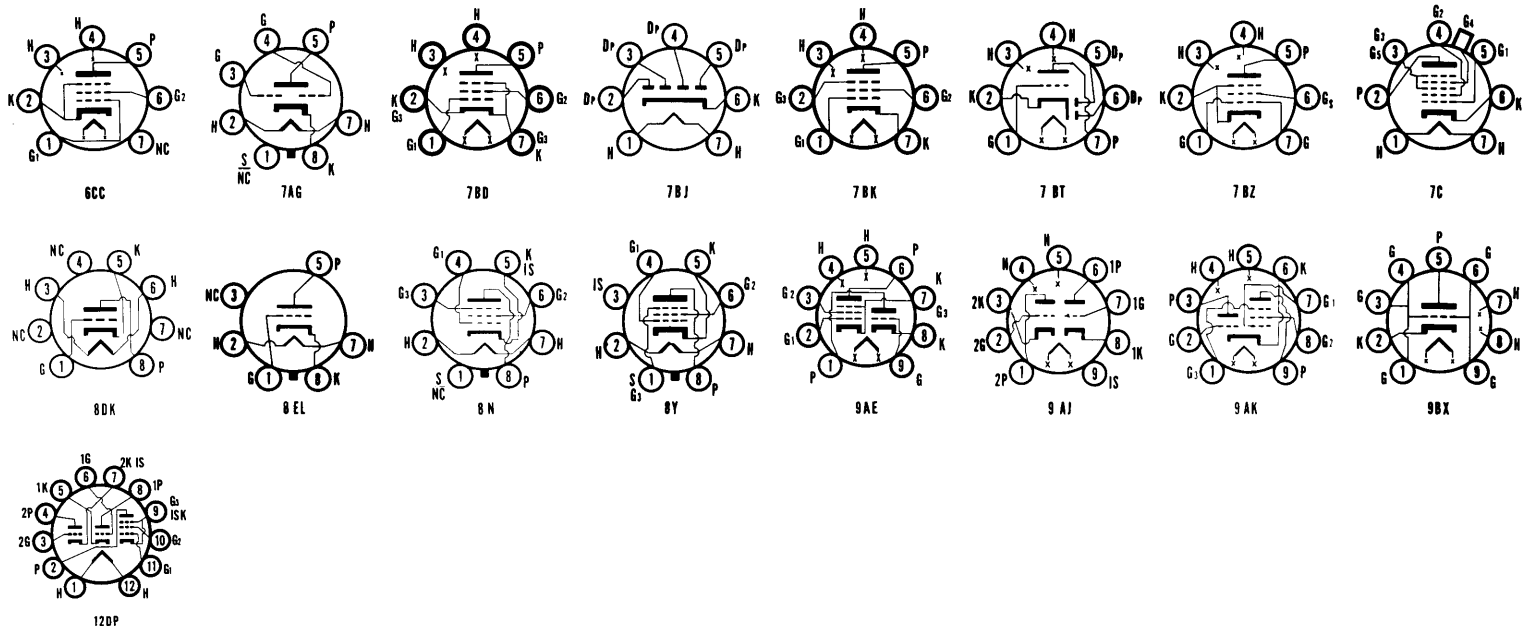

SYLVANIA TUBES

TYPE	CONSTRUCTION			EMITTER		USE	Plate Diss. Watts ²	Plate Volts	Negative Grid Volts	Screen Volts	Plate Current Ma.	Screen Current Ma.	Plate Resis. Ohms	Transconductance Micros.	Amplification Factor	Ohms Load for Stated Power Output	Power Output Milli-watts
	Bulb Size or Style ¹	Class	Basing Diag.	Volts	Amps.												
6AT6	T-5½	Duodiode Tri.	7BT	6.3	0.300	Det. Amp.	0.55	100 250	1.0 3.0	0.8 1.0	54000 58000	1300 1200	70 70
6AT8 6AT8A	T-6½	Tri. Pentode	9DW	6.3 6.3*	0.450 0.450	VHF Osc. VHF Amp.	1.7 2.3	125 125	1.0 1.0 125	12 9 2.2	6000 300000	6500 5500	40
6AU4GTA 6AU5GT	T-9	Diode Beam Pent.	4CG 6CK	6.3	1.800 1.250	T.V. Damper Horiz. Defl. Amp.	6.6	P.I.V. = 4500 Volts Max. D.C. Plate Current = 210 Ma. Max. Max. Peak Positive Pulse Plate Voltage = 5500 Volts. Max. D.C. Plate Current = 110 Ma.									
6AU6 6AU6A GB-6AU6WB(3)	T-5½	Pentode	7BK	6.3 6.3*	0.300 0.300	R-F Amp.	3.3	100 250 250	150 [■] 100 [■] 68 [■]	100 125 150	5.0 7.6 10.6	2.1 3.0 4.3	500000 1.5 Meg. 1.0 Meg.	3900 4500 5200
6AU8	T-6½	Tri. Pentode	9DX	6.3*	0.600	Tri. Amp. Pent. Video Amp.	2.75 3.3	150 200 250	150 [■] 82 [■] 82 [■] 150 125	9.5 17.0 9.5 3.6 3.4	7200 140000	5600 8000	40
6AU8A	T-6½	Tri. Pentode	9DX	6.3*	0.600	Tri. Amp. Pent. Video Amp.	2.75 3.3	150 200	150 [■] 82 [■] 125	9.5 17 3.4	8100 100000	5300 8000	40
6AV5GA	T-11 or T-12	Beam Pentode	6CK	6.3	1.200	Horizontal Defl. Amp.	.12	250	22.5	150	55	2.1	20000	5500	4.3	When Eb = 150
6AV6	T-5½	Duodiode Tri.	7BT	6.3	0.300	Det. Amp.	0.55	250 100	2.0 1.0	1.2 0.5	62500 80000	1600 1250	100
6AV11	Comp. T-9	Triple Triode	12BY	6.3	0.600	Gen. Purpose	6.0	100 250	0 8.5	11.8 10.5	6500 7700	3100 2200	20 17
6AW8 6AW8A	T-6½	Tri. Pentode	9DX	6.3*	0.600	Tri. Amp. Pent. Video Amp.	1.1 3.75	200 150	2.0 150 [■] 150	4.0 15 3.5	17500 200000	4000 9500	70
6AX3 6AX4GT 6AX4GTA 6AX5GT	Comp. T-9 T-9 T-9 T-9	Diode Diode Diode Duodiode	12BL 4CG 4CG 6S	6.3 6.3 6.3 6.3	1.200 1.200 1.200 1.200	T.V. Damper T.V. Damper T.V. Damper F-W Rect.	5.3 5.28 5.28	P.I.V. = 4400 Volts Max., D.C. Plate Current = 125 Ma. Max. P.I.V. = 4400 Volts Max., D.C. Plate Current = 165 Ma. 350 A.C. Volts Per Plate, R.M.S., 125 Ma. D.C. Output. Condenser Input to Filter. 450 A.C. Volts Per Plate, R.M.S., 125 Ma. D.C. Output. Choke Input to Filter.									
6AX7	T-6½	Duotriode	9A	6.3/ 3.15*	0.300/ 0.600	A-F Amp.	1.1	Characteristics Same as Type 12AX7. (6AX7 Designed for Series String Receivers.)									
6AX8	T-6½	Tri. Pentode	9AE	6.3	0.450	Sync. Sep. Video Amp.	2.97 3.0	150 250	56 [■] 120 [■] 110	18 10 3.5	5000 400000	8500 4800	40
6AY3 6AY3A	Novar T-9	Diode	9HP	6.3	1.200	T.V. Damper	6.5	Maximum Peak Inverse Plate Voltage = 5000 Volts, Maximum D.C. Plate Current = 175 Ma.									
6AY11	Comp. T-9	Duodiode Duotriode	12DA	6.3	0.690	T-FM Det. P-AF Amp. 1.0	Average Diode Current (Each Diode) with 5 Volts Applied = 18 Ma. 250 2 1.2 52700 1900 100 Plate Supply Voltage = 50 Volts, RMS, Each Plate. D.C. Output Current = 4 Ma. Each Plate. Capacitor Input to Filter.									
6AZ5	T-3	Duodiode	8DF	6.3	0.150	Rectifier	Plate Supply Voltage = 50 Volts, RMS, Each Plate. D.C. Output Current = 4 Ma. Each Plate. Capacitor Input to Filter.									
6AZ8	T-6½	Tri. Pentode	9ED	6.3	0.450	Sync. Sep. Video Amp.	2.86 2.2	200 200	6 180 [■] 150	13.0 9.5 3.0	5750 300000	3300 6000	19
6B3	T-6½	Diode	9BD	6.3	1.200	T.V. Damper	Maximum Peak Inverse Plate Voltage = 4400 Volts. Maximum D.C. Plate Current = 150 Ma.									
6B4G	ST-16	Triode	5S	6.3 [†]	1.000	Power Amp.	16.5	Characteristics Same as Type 6A3.									
6B8	Metal	Duodi. Pent.	8E	6.3	0.300	Det. Amp.	3.3	Characteristics Same as Type 6B7, Except Capacitances.									
6B10	Comp. T-9	Duodiode	12BF	6.3*	0.600	Horiz. Phase Det./Osc.	2.5	250	9.5	7	9750	1850	18
6BA3	T-9	Diode	9HP	6.3	1.200	T.V. Damper	5.3	Maximum Peak Inverse Plate Voltage = 5000 Volts. Maximum D.C. Output Current = 165 Ma.									
6BA5	T-3	Pentode	8DY	6.3	0.150	A-F Amp.	0.77	100	270 [■]	100	5.5	2.0	175000	2150
6BA6	T-5½	Pentode	7BK	6.3	0.300	R-F Amp.	3.3	100 250	68 [■] 68 [■]	100 100	10.8 11.0	4.4 4.2	250000 1.0 Meg.	4300 4400
6BA7	T-6½	Heptode	8CT	6.3	0.300	Converter	2.2	100 250	1.0 1.0	100 100	3.6 3.8	10.2 10.0	500000 1 Meg.	900 [■] 950 [■]
6BA8 6BA8A	T-6½	Tri. Pentode	9DX	6.3*	0.600	Tri. Amp. Pent. Video Amp.	2.2 3.57	200 200	8.0 180 [■] 150	8.0 13.0 3.5	6700 400000	2700 9000	18
6BA8 and 6BA8A are Similar Except for Plate Knee Characteristics of 6BA8A.																	

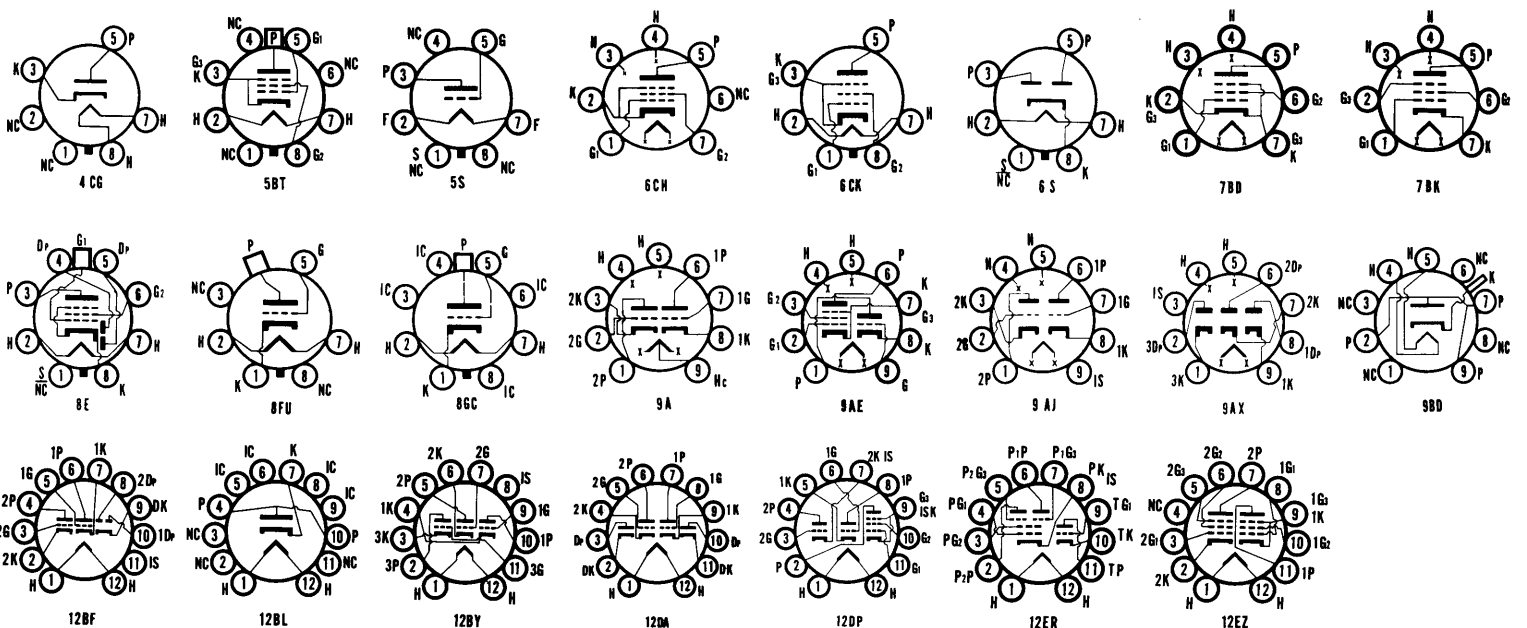

AVERAGE CHARACTERISTICS

TYPE	CONSTRUCTION			EMITTER		USE	Plate Diss. Watts ²	Plate Volts	Negative Grid Volts	Screen Volts	Plate Current Ma.	Screen Current Ma.	Plate Resis. Ohms	Transconductance Micros.	Amplification Factor	Ohms Load for Stated Power Output	Power Output Milli-watts	
	Bulb Size or Style ¹	Class	Basing Diag.	Volts	Amps.													
6BA11	Comp. T-9	Triode Twin-Pentode	12ER	6.3*	0.600	T-Vert. Osc. P-Sync. AGC	1.5 1.1	250 100	11 0	67.5	5.0	1800 1700	18	
6BC5	T-5½	Pentode	7BD	6.3	0.300	Tri. Amp.	2.75	250 180	820 [¶] 330 [¶]	...	6.0	9000 6000	4400 6000	40
						Pent. Amp.	2.2	100 125 250	180 [¶] 100 [¶] 180 [¶]	100	4.7	1.4	600000 500000 800000	4900 6100 5700
6BC7	T-6½	Triple Diode	9AX	6.3	0.450	F. M. Det.	...	High Perveance Diode.										
6BC8	T-6½	Duotriode	9AJ	6.3	0.400	Det. Amp.	2.2	150	220 [¶]	...	10.0	...	5300	6200	35	
6BD4	T-12	Beam Triode	8FU	6.3	0.600	Hi-Volt. Reg.	22	20000 Max. D.C. Plate Volts. 125 Max. D.C. Grid Volts. 1.5 Ma. Max. D.C. Plate Current.										
6BD4A	T-12	Beam Triode	8FU	6.3	0.600	Hi-Volt. Reg.	27.5	27000 Max. D.C. Plate Volts. 125 Max. D.C. Grid Volts. 1.5 Ma. Max. D.C. Plate Current.										
6BD5GT	T-9	Beam Pent.	6CK	6.3	0.900	Horiz. Defl. Amp.	11	Max. Peak Positive Pulse Plate Voltage = 4000 Volts. Max. D.C. Cathode Current = 100 Ma.										
6BD6	T-5½	Pentode	7BK	6.3	0.300	R-F Amp.	3.3	250 100	3.0 1.0	100 100	9.0 13	3.5 5.0	700000 120000	2000 2350	
6BD11	Comp. T-9	Hi Mu Triode Med. Mu Tri. Sharp Cutoff Pentode	12DP	6.3	0.600	Gen. Pur. Amp.	2.0	200	2	...	7.0	...	12400	5500	68	
						Sync. Sep.	1.5	200	220 [¶]	...	9.2	...	9400	4400	41	
						Video Amp.	4.0	135	100 [¶]	135	17	4.0	45000	10400	
6BE3	Comp. T-9	Diode	12BL	6.3*	0.600	T.V. Damper	6.5	Max. Peak Inverse Plate Voltage = 5000 Volts. Max. D.C. Output Current = 200 Ma.										
6BE6	T-5½	Heptode	7CH	6.3	0.300	Converter	1.1	100 250	1.5 1.5	100 100	2.6 2.9	7.0 6.8	40000 1.0 Meg.	455 [†] 475 [†]	(Osc. Grid Res. = 20000 Ohms) (Osc. Grid Current 0.5 Ma.)			
6BE8	T-6½	Tri. Pentode	9EG	6.3	0.450	VHF Osc.	2.75	150	56 [¶]	...	18.0	...	5000	8500	40	
6BE8A	T-6½	Tri. Pentode	9EG	6.3*	0.450	VHF Amp.	3.0	250	68 [¶]	110	10.0	3.5	400000	5200	
6BF5	T-5½	Pentode	7BZ	6.3	1.200	S.T.A1 Amp.	6.0	110	7.5	110	36	4	12000	7500	...	2500	1900	
6BF6	T-5½	Duodiode Tri.	7BT	6.3	0.300	Det. Amp.	2.75	250	9.0	...	9.5	...	8500	1900	16	10000	300	
6BF7W (3)	T-3	Duotriode	8DG	6.3	0.300	R-F Amp.	1.1	100	100 [¶]	...	8.0	...	7000	4800	35	
								100	100 [¶]	...	8.0	...	7000	4800	35
6BF8	T-6½	Sextuple Diode	9NX	6.3	0.450	Shunt Detector	...	Maximum Peak Inverse Plate Voltage = 165 Volts. Maximum Peak Plate Current, Per Plate = 11 Ma., Maximum D.C. Output Current = 2.2 Ma.										
6BF11	Comp. T-9	Power Pent. Dual Control Pentode	12EZ	6.3	0.600	A-F Out. Amp.	6.5	145	6.0	110	36-40†	3-9†	30000	8600	...	3000	2400	
						F-M Detector	1.7	150	560 [¶]	100	1.3	2.0	150000	G1-1000 G3-400	G1 Volts for Ib = 10 μa = -4.5 G3 Volts for Ib = 10 μa = -4.5	
6BG6GA	T-12	Beam Pent.	5BT	6.3	0.900	Horiz. Defl. Amp.	22	Maximum Peak Positive Plate Voltage = 6600 Volts. Maximum D.C. Cathode Current = 110 Ma.										
6BH3	Novar T-9	Diode	9HP	6.3	1.600	T.V. Damper	6.5	Maximum Peak Inverse Plate Voltage = 5500 Volts. Maximum D.C. Plate Current = 180 Ma.										
6BH6	T-5½	Pentode	7CM	6.3	0.150	R-F Amp.	3.3	100 250	1.0 1.0	100 150	3.6 7.4	1.4 2.9	0.7 Meg. 1.4 Meg.	3400 4600	
6BH8	T-6½	Tri. Pentode	9DX	6.3*	0.600	Tri. Amp. Pent. Amp.	2.75 3.3	150 200	5 82 [¶]	...	9.5 15.0	...	5150 150000	3300 7000	17	
6BJ3	Comp. T-9	Diode	12BL	6.3	0.600	T.V. Damper	4.0	Max. Peak Inverse Plate Voltage = 3300 Volts. Max. D.C. Plate Current = 140 Ma.										
6BJ5	T-5½	Pentode	6CH	6.3	0.640	Power Amp.	9.9	250	5.0	250	3.5	5.5	40000	10500	450	7000	4000	
6BJ6	T-5½	Pentode	7CM	6.3	0.150	R-F Amp.	3.3	250 100	1.0 1.0	100 100	9.2 9.0	3.3 3.5	1.3 Meg. 250000	3600 3650	
6BJ7	T-6½	Triple Diode	9AX	6.3	0.450	TV DC Rest'r	...	Each Section Similar to Each Section of a 6AL5.										
6BJ8	T-6½	Duodiode Tri.	9ER	6.3*	0.600	Det. Amp.	3.85	90	0	...	13.5	...	4700	4700	22	
								250	9	...	8.0	...	7150	2800	20	
6BK4	T-12	Beam Triode	8GC	6.3	0.200	Hi-Volt. Reg.	27.5	25000 Maximum D.C. Plate Volts. 125 D.C. Grid Volts. 1.5 Ma. Maximum D.C. Plate Current.										
6BK4A	T-12	Triode	8GC	6.3	0.600	Beam Triode	3.0	Max. D.C. Plate Voltage = 27,000 Volts. Max. D.C. Grid Voltage = 135 Volts. Max. D.C. Plate Current = 1.6 Ma.										
6BK5	T-6½	Beam Pent.	9BQ	6.3	1.200	Power Amp.	9.9	250	5.0	250	35	3.5	0.1 Meg.	8500	...	6500	3500	

(1) See Frontal Section. (2) Design Maximum Values. (3) Has Special Mechanical and/or Life Characteristics. (4) Average Contact Potential Bias Developed Across Specified Grid Resistor. * Controlled Heater Warm-up Time (applies to parallel connections of types having a tapped heater.) † Maximum Signal. ‡ Filamentary Type. ¶ Conversion Transconductance. †† Plate to Plate. ‡‡ Cathode Resistor (ohms).

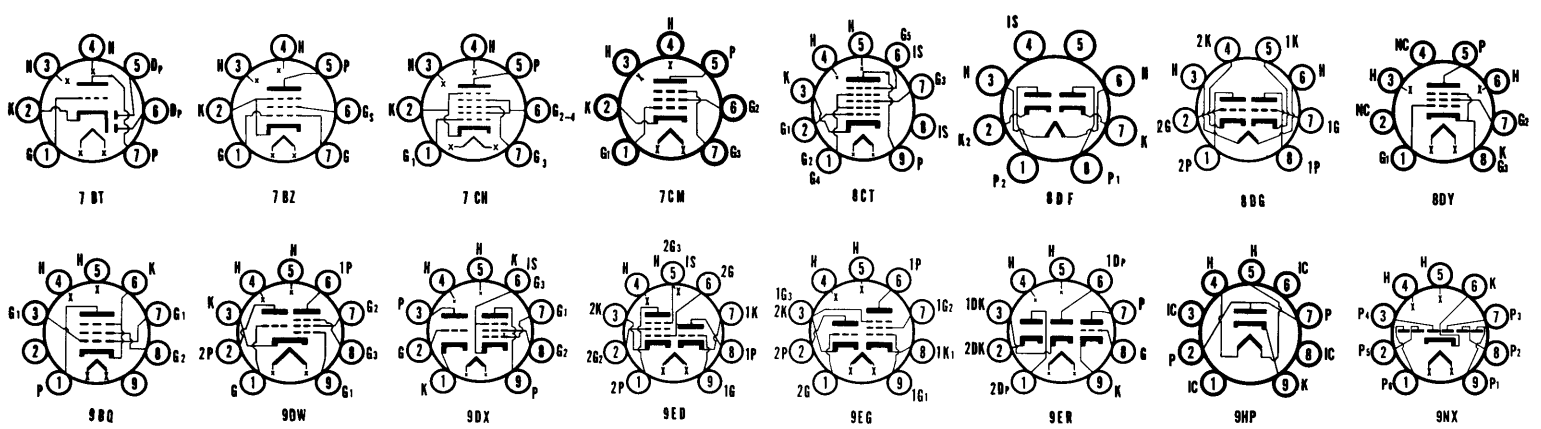

SYLVANIA TUBES

TYPE	CONSTRUCTION			EMITTER		USE	Plate Diss. Watts ²	Plate Volts	Negative Grid Volts	Screen Volts	Plate Current Ma.	Screen Current Ma.	Plate Resis. Ohms	Transconductance Micros.	Amplification Factor	Ohms Load for Stated Power Output	Power Output Milli-watts
	Bulb Size or Style ¹	Class	Basing Diag.	Volts	Amps.												
6BK7A 6BK7B	T-6½	Duotriode	9AJ	6.3 6.3*	0.450 0.450	VHF Amp.	2.97	150	56 [■]	18.0	...	4600	9300	43
6BL4	T-12	Diode	8GB	6.3	3.000	T.V. Damper	8.8	P.I.V. = 4500 Volts Abs. Max.	D.C. Plate Current = 200 Ma. Max.
6BL7GT 6BL7GTA	T-9	Duotriode	8BD	6.3	1.500	Vert. Osc. Vert. Defl. Amp.	11 13.2	Max. Peak Positive Pulse Plate Voltage = 2000 Volts.	Max. D.C. Cathode Current = 60 Ma.	2150	7000	15
6BL8	T-6½	Tri. Pentode	9DC	6.3	0.450	VHF Osc. VHF Amp.	1.65 1.87	100	2.0	14.0	400000	5000	20
6BM8	T-6½	Tri. Pentode	9EX	6.3	0.780	Pent. Vert. Defl. Amp. Tri. Vert. Osc.	5.5 1.1	Max. Peak Positive Pulse Plate Voltage = 2500 Volts.	Max. D.C. Cathode Current = 50 Ma.	20000	6400	9.5
6BN4A	T-5½	Triode	7EG	6.3	0.200	VHF Amp.	2.42	150	220 [■]	9	8000	5400	43
6BN6	T-5½	Gated Beam	7DF	6.3	0.300	Quad. F. M. Det.	65	1.3	60	0.23	5.0
6BN8	T-6½	Duodiode Tri.	9ER	6.3*	0.600	Det. Amp.	1.65	100	1	1.5	21000	3500	75
6BQ5	T-6½	Beam Pent.	9CV	6.3	0.760	S.T. A1 Amp. P.P. AB1 Amp.	13.2	250	135 [■]	250	48	5.5	38000	11300	5200	5700
6BQ6GTA 6BQ6GTB	T-9 T-9	Beam Pent.	6AM	6.3	1.200	Horiz. Defl. Amp.	12.1	6000	Maximum Peak Positive Plate Volts. 110 Ma. Maximum Cathode Current.	14500	5900
6BQ7A	T-6½	Duotriode	9AJ	6.3	0.400	VHF Amp.	2.2	150	22.5	150	57	2.1	5800	6000	38
6BR3	T-6½	Diode	9CB	6.3	1.200	T.V. Damper	6.5	Max. Peak Inverse Plate Voltage = 5500 Volts.	Max. D.C. Plate Current = 200 Ma.
6BR8A	T-6½	Triode Pentode	9FA	6.3*	0.450	Oscillator Mixer	2.97 3.0	150	56 [■]	18	5000	8500	40
6BS3	Novar T-9	Diode	9HP	6.3	1.200	T.V. Damper	6.0	Max. Peak Inverse Plate Voltage = 5000 Volts.	Max. D.C. Plate Current = 200 Ma.
6BS8	T-6½	Duotriode	9AJ	6.3	0.400	VHF Amp.	2.2	150	220 [■]	10	5000	7200	36
6BT8	T-6½	Duodi. Pent.	9FE	6.3	0.450	Amp. Det.	2.2	200	180 [■]	150	9.5	2.8	300000	6200
6BU4	T-12	Triode	8GC	6.3	0.450	H.V. Reg.	27.5	25000	8.4	1.0	8.2 Meg.	185	1515
6BU5	T-11	Beam Power Pentode	8FP	6.3	0.150	H.V. Reg.	20	20K	3.4	70	0.6
6BU8 6BU8A	T-6½	Duo Pentode	9FG	6.3	0.300	Sync. Sep.	1.1	100	0 Grid 1	67.5	180 Gr. 3	Grid No. 3 Volts = -4.5
6BV8	T-6½	Duodiode Tri.	9FJ	6.3*	0.600	Det. Amp.	2.7	200	330 [■]	11.0	5900	5600	33
6BW4	T-6½	Duodiode	9DJ	6.3	0.900	F-W Rect.	325 A.C. Volts Per Plate, RMS, 100 Ma. Output Current.	Capacitor Input to Filter.
6BW8	T-6½	Duodi. Pent.	9HK	6.3*	0.450	R-F or I-F Amplifier	3.0	250	68 [■]	110	10.0	3.5	250000	5200
6BX7GT	T-9	Duotriode	8BD	6.3	1.500	Vert. Amp. Vert. Osc.	11 13.2	Max. Peak Positive Pulse Plate Volts = 2000 Volts.	Max. D.C. Cathode Current = 60 Ma.	1300	7600	10
6BX6	T-6½	Pentode	9AQ	6.3	0.300	R-F/I-F Amp.	2.75	170	2.0	170	10	2.5	400000	7200
6BX8	T-6½	Duotriode	9AJ	6.3	0.400	VHF Amp.	2.0	65	1.0	9	6700	25
6BY5G	ST-14	Duodiode	6CN	6.3	1.600	F-W Rect.	375 A.C. Volts Per Plate, R.M.S., 175 Ma. D.C. Output Current.	Condenser Input to Filter.
6BY5GA	T-12	Duodiode	6CN	6.3	1.600	T.V. Damper	P.I.V. = 3000 Volts Abs. Max.	D.C. Plate Current = 175 Ma. Max. Each Plate.
6BY6	T-5½	Heptode	7CH	6.3	0.300	Sync. Sep.	2.2	10	G1&2=0	25	1.4	3.5	Plate Current = 50μ Amps. When Grid 3 V. = 2.5
6BY8	T-6½	Diode Pent.	9FN	6.3*	0.600	Det. Amp.	3.3	100	150 [■]	100	5.0	2.1	500000	3900
6BZ6	T-5½	Pentode	7CM	6.3	0.300	R-F Amp.	2.3	125	56 [■]	125	14	3.6	260000	8000	Semi-Remote Cutoff.
6BZ7	T-6½	Duotriode	9AJ	6.3	0.400	VHF Amp.	2.2	150	220 [■]	10	5300	6800	36
6BZ8	T-6½	Duotriode	9AJ	6.3	0.400	VHF Amp.	2.42	125	100 [■]	10	5600	8000	45
6C4	T-5½	Triode	6BG	6.3	0.150	R-F Osc. R-F Amp.	5.5 3.85	300	27	25	7700	2200	17	Class C	5500

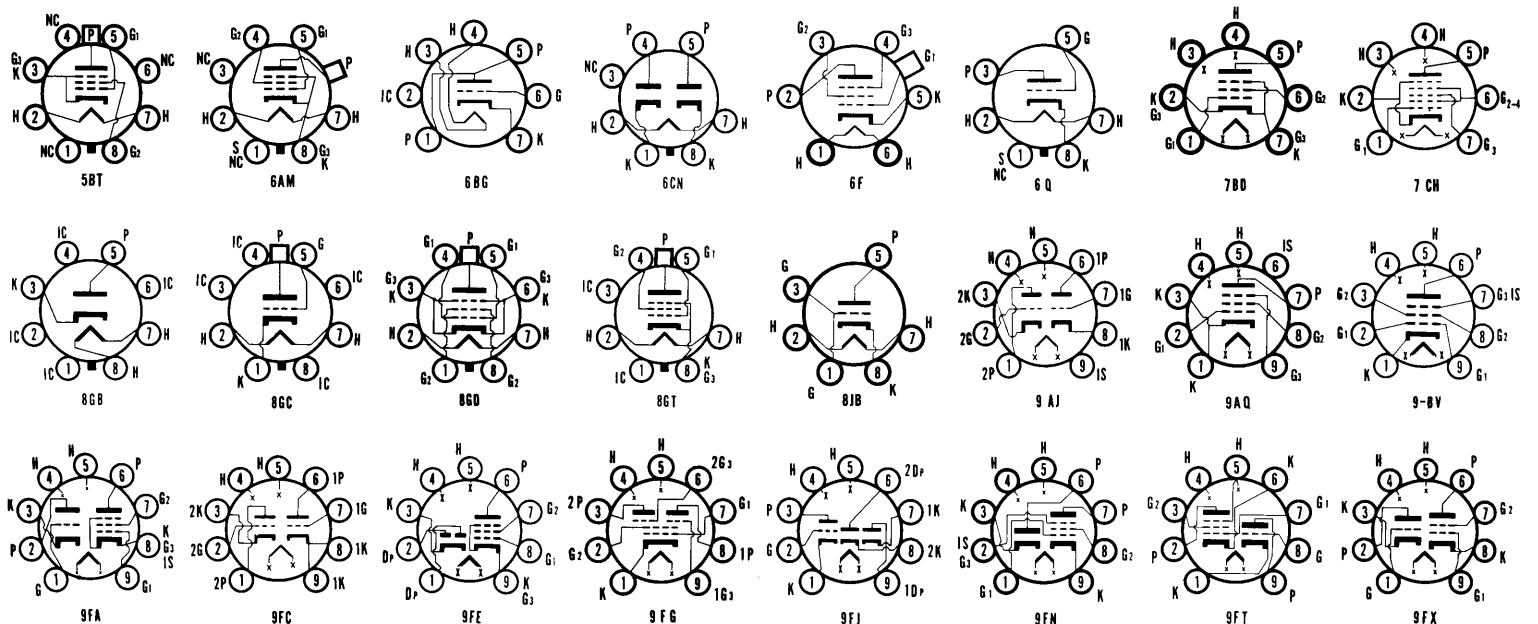

AVERAGE CHARACTERISTICS

TYPE	CONSTRUCTION			EMITTER		USE	Plate Diss. Watts ²	Plate Volts	Negative Grid Volts	Screen Volts	Plate Current Ma.	Screen Current Ma.	Plate Resis. Ohms	Transcon-ductance Micros.	Amplification Factor	Ohms Load for Stated Power Output	Power Output Milli-watts
	Bulb Size or Style ¹	Class	Basing Diag.	Volts	Amps.												
6C5 6C5GT	Metal T-9	Triode	6Q	6.3	0.300	Amplifier	2.75	250	8.0	...	8.0	...	10000	2000	20
6C6	ST-12	Pentode	6F	6.3	0.300	Amplifier	.825	100 250	3.0 3.0	100 100	2.0 2.0	0.5 0.5	1 Meg. 1 Meg. >	1185 1225
6C8G	ST-12	Duotriode	8G	6.3	0.300	Amplifier Inverter	1.1	250 250	4.5 3.0	3.2	22500	1600	36	(One Section) Output Volts 80, RMS for Inverter Service.	
6C9	T-6½	Duotetrode	10F	6.3	0.400	VHF Amp.	2.5	125	1.0	80	10	1.5	100000	8000
6C10	Comp. T-9	Triple Triode	12BQ	6.3*	0.600	A-F Amp.	1.0	Characteristics Same as Type 12AX7.									
6CA4	T-6½	Duodiode	9M	6.3	1.000	F-W Rect.	350 A.C. Volts Per Plate, RMS, 150 Ma. Output Current.									
6CA5	T-5½	Beam Pent.	7CV	6.3	1.200	Power Amp.	5.5	110 125	4.0 4.5	110 125	32 37	3.5 4.0	16000 15000	8100 9200	3500 4500	1100 1500
6CA7	T-10 (SP)	Beam Pent.	8ET	6.3	1.500	Power Amp.	27.5	Characteristics Same as Type EL34.									
6CB5A	T-12	Beam Pent.	8GD	6.3	2.500	Horiz. Defl. Amp.	25	175	30	175	90	6.0	5000	8800
6CB6A	T-5½	Pentode	7CM	6.3*	0.300	VHF Amp.	2.3	125	56 [¶]	125	13	3.7	280000	8000
6CD6G	ST-16	Beam Pent.	5BT	6.3	2.500	Horiz. Defl. Amp.	16.5	Maximum Peak Positive Plate Voltage = 6600 Volts. Maximum D.C. Plate Current = 200 Ma.									
6CD6GA	T-12	Beam Pent.	5BT	6.3	2.500	Horiz. Defl. Amp.	22	175	30	175	75	5.5	7200	7700
6CE5	T-5½	Pentode	7BD	6.3	0.300	VHF Amp.	2.2	125	1.0	125	111	3.7	1.0 Meg.	7600
6CF6	T-5½	Pentode	7CM	6.3	0.300	VHF Amp.	2.3	125	56 [¶]	125	12.5	3.7	0.3 Meg.	7800
6CG7	T-6½	Duotriode	9AJ	6.3*	0.600	Amplifier	3.85	Characteristics Same as Type 6SN7GT. (6CG7 Designed for Series String Receivers.)									
6CG8 6CG8A	T-6½	Tri. Pentode	9GF	6.3 6.3*	0.450 0.450	Osc. Mixer	1.7 2.3	125 125	1.0 1.0 125	12 9 2.2	6000 .3 Meg.	6500 5500	40
6CH7	T-6½	Duotriode	9FC	6.3	0.400	Amplifier	2.2	150	220 [¶]	10	5300	6800	36
6CH8	T-6½	Tri. Pentode	9FT	6.3	0.450	Tri. Amp. Pent. Amp.	2.82 2.2	200 200 180 [¶] 150	13.0 9.5 2.8	5750 300000	3300 6200	19
6CK4	T-9	Power Triode	8JB	6.3	1.250	Vert. Defl. Amp.	12	250	28	40	1200	5500	6.6	Max. Peak Positive Pulse Plate Voltage = 2000 Volts. Max. D.C. Cathode Current = 100 Ma.	
6CL5	T-12	Beam Pent.	8GD	6.3	2.500	Horiz. Defl. Amp.	27.5	7000 Maximum Peak Positive Pulse Plate Volts. 25 Watts Maximum Plate Dissipation. 4.0 Watts Maximum Screen Dissipation.									
6CL6	T-6½	Power Pent.	9BV	6.3	0.650	Video Amp.	8.25	250	3	150	30	7	0.15 Meg.	11000
6CL8A	T-6½	Tri. Tetrode	9FX	6.3*	0.450	VHF Osc. VHF Amp.	2.97 3.0	125 125	1.0 1.0 125	14 12 4	5000 200000	8000 6500	40
6CM4	T-6½	Triode	9KG	6.3	0.170	VHF Amp.	2.2	175	1.5	12	14000	68
6CM5	T-9	Beam Pent.	8GT	6.3	1.250	Horiz. Defl. Amp.	11	100	7.7	100	100	7.0	5300	14000
6CM6	T-6½	Beam Pent.	9CK	6.3	0.450	Vert. Defl. Amp. Power Amp.	8.8 13.2	250 180	12.5 8.5	250 180	45 29.0	4.5 3.0	50000 50000	4100 3700	5500 5000	2000 4500
6CM7	T-6½	Duotriode	9ES	6.3*	0.600	Sect. 2 Vert. Defl. Amp. Sect. 1 Vert. Osc.	6.0 1.37	250 200	8.0 7.0	20.0 5.0	4100 11000	4400 2000	18 20
6CM8	T-6½	Tri. Pentode	9FZ	6.3*	0.450	Class A1 Amp.	1.1 2.2	250 200	2 180 [¶] 150	1.8 9.5 2.8	50000 600000	2000 6200	100

(1) See Frontal Section. (2) Design Maximum Values. † Maximum Signal. (3) Has Special Mechanical and/or Life Characteristics. (4) Average Contact Potential Bias Developed Across Specified Grid Resistor. ‡ Filamentary Type. * Controlled Heater Warm-up Time (applies to parallel connections of types having a tapped heater.) † Plate to Plate. ‡ Cathode Resistor (ohms).

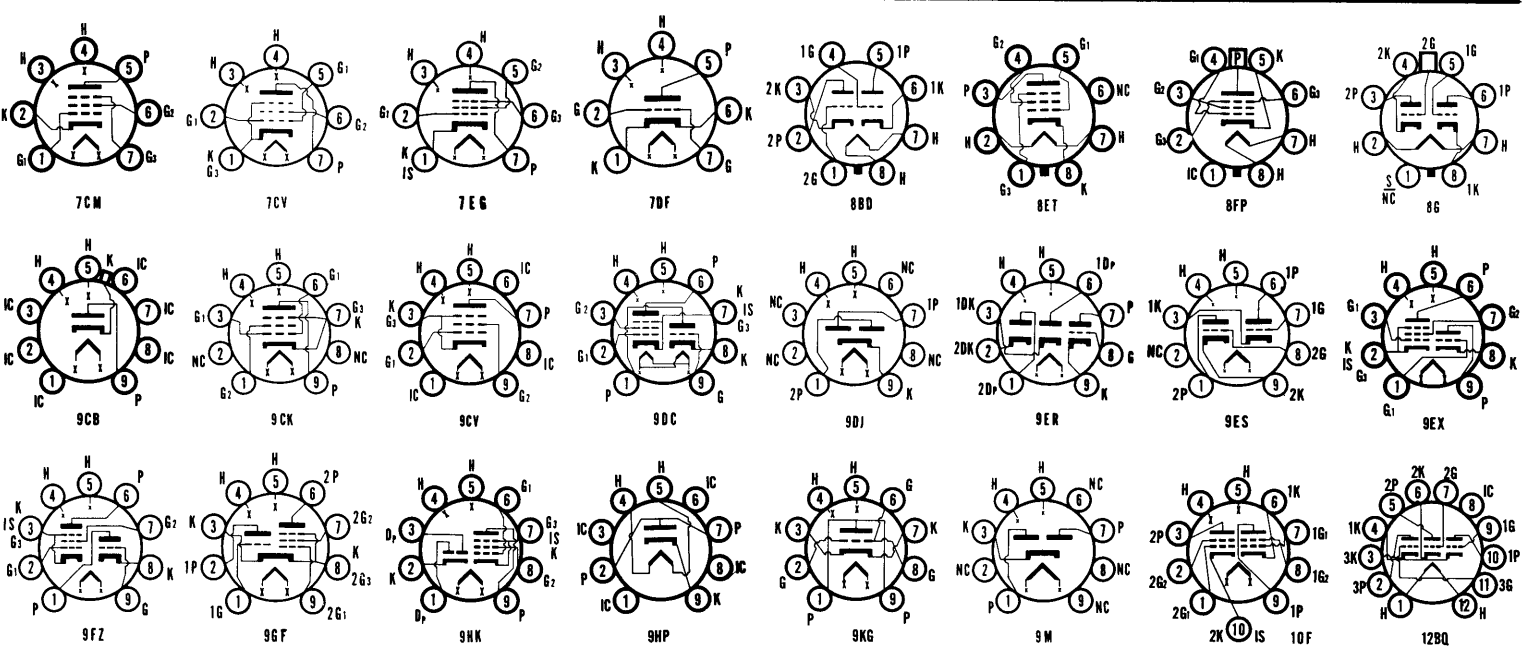

SYLVANIA TUBES

TYPE	CONSTRUCTION			EMITTER		USE	Plate Diss. Watts ²	Plate Volts	Negative Grid Volts	Screen Volts	Plate Current Ma.	Screen Current Ma.	Plate Resis. Ohms	Transconductance Micros.	Amplification Factor	Ohms Load for Stated Power Output	Power Output Milli-watts
	Bulb Size or Style ¹	Class	Basing Diag.	Volts	Amps.												
6CN7	T-6½	Duodiode Tri.	9EN	6.3	0.300	Det. Amp.	1.1	100 250	1.0 3.0	0.8 1.0	54000 58000	1300 1200	70 70
6CQ4	T-9	Diode	4CG	6.3	1.600	T.V. Damper	6.5	Max. Peak Inverse Plate Voltage = 5500 Volts. Max. D.C. Plate Current = 190 Ma.									
6CQ8	T-6½	Tri. Tetrode	9GE	6.3*	0.450	VHF Tri. Osc. VHF Tet. Amp.	2.97 3.0	125 125	56 ^m 1.0 125	15 12	5000 140000	8000 5800	40
6CR4	T-6½	Triode	9BX	6.3	0.370	UHF Amp.	130	1.0	16	15000	60
6CR6	T-5½	Diode Pent.	7EA	6.3	0.300	Det.-Audio Amplifier	2.75	250	2.0	100	9.5	3.0	200000	1950
6CR8	T-6½	Tri. Pentode	9GJ	6.3*	0.450	Tri. Amp. Pent. Amp.	2.75 2.3	125 125	2.0 56 ^m 125	12.0 13.0 3.0	5500 300000	4000 7700	22
6CS6	T-5½	Dual Control Heptode	7CH	6.3	0.300	Sync. Sep.	1.1	100 100	0 Grid 1 -1 Grid 1	30 30	0.8 1.0	5.5 1.3	0.7 Meg. 1.0 Meg.	1500 Gr. 3 1100 Gr. 1	Grid No. 3 Volts = -1.0 Grid No. 3 Volts = 0.
6CS7	T-6½	Duotriode	9EF	6.3*	0.600	Sect. 2 Vert. Defl. Amp. Sect. 1 Vert. Osc.	1.37	250 250	10.5 8.5	19.0 10.5	3450 7700	4500 2200	15.5 17
6CS8	T-6½	Tri. Pentode	9FZ	6.3*	0.450	Tri. Amp. Pent. Amp.	2.75 2.3	125 125	2.0 56 ^m 125	12.0 13.0 3.0	5500 300000	4000 7700	22
6CU5	T-5½	Pentode	7CV	6.3	1.200	Power Amp.	6.6	120	8	110	49	4	10000	7500	2500	2300
6CU6	T-12	Beam Pent.	6AM	6.3	1.200	Horiz. Amp.	12.1	Characteristics and Ratings Same as Type 6BQ6GTA.									
6CU8	T-6½	Tri. Pentode	9GM	6.3*	0.450	Tri. Amp. Pent. Amp.	2.82 2.2	125 125	1.0 56 ^m 125	17 12 3.8	4100 170000	5800 7800	17
6CW4	M-N	Triode	12AQ	6.3	0.135	VHF Amp.	1.0	70	47K ⁴	8	12500	5440	68
6CW5	T-6½	Beam Pent.	9CV	6.3	0.760	S.T. A1 Amp. S.T. A1 Amp. P.P.AB1 Amp.	13	100 170 170	6.7 12.5 120 ^m	100 170 170	43 70 5	3 5 6-41†	23000	9000 2400 2400	1900 5600 13000	
6CX7	T-6½	Duotriode	9FC	6.3	0.400	Amplifier	2.2	150	220 ^m	9.0	6400	39
6CX8	T-6½	Tri. Pentode	9DX	6.3	0.750	Tri. Amp. Video Amp.	2.0 5.0	150 200	150 ^m 68 ^m 125	9.2 24 5.2	8700 70000	4600 10000	40
6CY5	T-5½	Tetrode	7EW	6.3	0.200	VHF Amp.	2.0	125	1.0	80	10.0	1.5	100000	8000
6CY7	T-6½	Duotriode	9LG	6.3	0.750	Vert. Osc. Vert. Defl. A.	1.0 5.5	250 150	3 620 ^m	1.2 30	52000 920	1300 5400	68 5
6CZ5	T-6½	Beam Pent.	9HN	6.3*	0.450	Vert. Defl. Amp.	11	250	14	250	46.0	4.6	73000	4800
6D4	T-5½	Gas Triode	5AY	6.3	0.250	Relay Tube	350	50
6D6	ST-12	Pentode	6F	6.3	0.300	Amplifier	2.47	100 250	3.0 3.0	100 100	8.0 8.2	2.2 2.0	250000 800000	1500 1600
6D10	Comp. T-9	Triple Triode	12BQ	6.3	0.450	VHF R-F/Osc./Mixer	2.0	Characteristics Same as Type 6EZ8.									
6DA4	T-9	Diode	4CG	6.3	1.200	T.V. Damper	5.5	Max. Peak Inverse Plate Voltage = 4400 Volts. Max. D.C. Plate Current = 155 Ma.									
6DA4A	T-9	Diode	4CG	6.3	1.200	T.V. Damper	8.0	Max. Peak Inverse Plate Voltage = 5000 Volts. Max. D.C. Plate Current = 185 Ma.									
6DA7	T-6½	Duotriode	9EF	6.3	1.000	Sect. 2 Vert. Defl. Amp. Sect. 1 Vert. Osc.	2.2 6.6	150 250	17.5 8.0	40.0 9.0	1100 7700	5700 2600	6.3 20
6DB5	T-6½	Beam Pent.	9GR	6.3	1.200	Vert. Defl. Amp.	11	200	180 ^m	125	46.0	2.2	28000	8000
6DB6	T-5½	Pentode	7CM	6.3	0.300	Color Demod.	3.3	150	1.0	150	5.8	6.6	50000	2050 μhos	when Eg3 = -3 Volts.
6DC6	T-5½	Pentode	7CM	6.3	0.300	Amplifier	2.2	200	180 ^m	150	9.0	3.0	500000	5500	Semi-Remote Cutoff.
6DC8	T-6½	Duodi. Pent.	9HE	6.3	0.300	R-F Amp.	2.47	200	1.5	100	11	3.3	.6 Meg.	4500
6DE4	T-9	Diode	4CG	6.3	1.600	T.V. Damper	6.5	P.I.V. = 5500 Volts Max., D.C. Plate Current = 180 Ma. Max.									

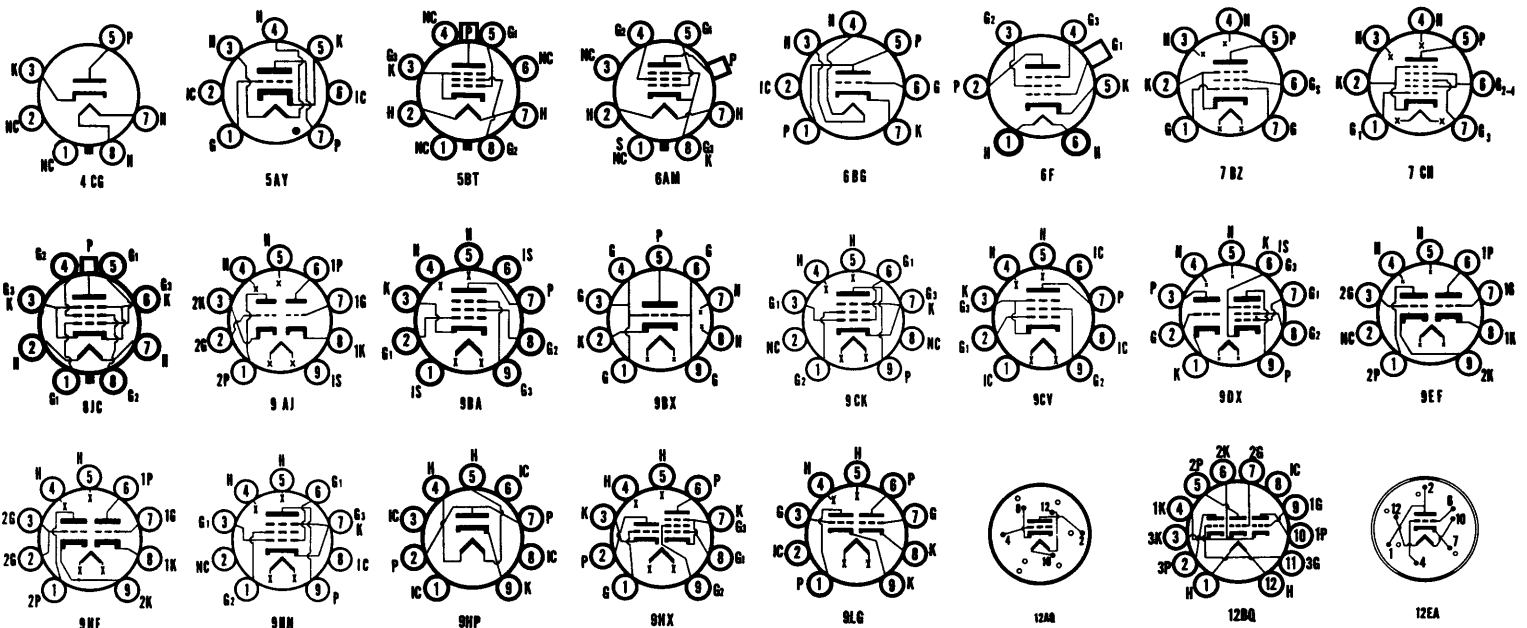

AVERAGE CHARACTERISTICS

TYPE	CONSTRUCTION			EMITTER		USE	Plate Diss. Watts ²	Plate Volts	Negative Grid Volts	Screen Volts	Plate Current Ma.	Screen Current Ma.	Plate Resis. Ohms	Transconductance Micros.	Amplification Factor	Ohms Load for Stated Power Output	Power Output Milli-watts
	Bulb Size or Style ¹	Class	Basing Diag.	Volts	Amps.												
6DE6	T-5½	Pentode	7CM	6.3	0.300	VHF Amp.	2.3	125	56 [■]	125	15.5	4.2	250000	8000
6DE7	T-6½	Duotriode	9HF	6.3	0.900	Sect. 2 Vert. Defl. Amp. Sect. 1 Vert. Osc.	7.0 1.5	150 250	17.5 11.0	35.0 5.5	925 8750	6500 2000	6 17.5
6DG6GT	T-9	Beam Pent.	7S	6.3	1.200	Power Amp.	11	110 200	7.5 180 [■]	110 125	49 46	4.0 2.2	13000 28000	8000 8000	2000 4000	2100 3800
6DG7	T-6½	Pentode	9BA	6.3	0.300	R-F or I-F Amplifier	3.3	100 250	68 [■] 68 [■]	100 100	10.8 11.0	4.4 4.2	250000 1 Meg.	4300 4400
6DJ8	T-6½	Duotriode	9AJ	6.3	0.365	VHF Amp.	1.98	90	1.3	15	2700	12500	33
6DK6	T-5½	Pentode	7CM	6.3	0.300	VHF Amp.	2.2	125	56 [■]	125	12.0	3.8	9800
6DM4	T-9	Diode	4CG	6.3	1.200	T.V. Damper	6.5
6DM4A	T-9	Diode	4CG	6.3	1.200	T.V. Damper	6.5
6DN6	T-12	Beam Pent.	5BT	6.3	2.500	Horiz. Defl. Amp.	16.5	125	18	125	70	6.3	4000	9000
6DN7	T-9	Duotriode	8BD	6.3	0.900	Sect. 2 Vert. Defl. Amp. Sect. 1 Vert. Osc.	10 1.0	250 250	9.5 8	41 8.0	2000 9000	7700 2500	15.4 22.5
6DQ4	T-9	Diode	4CG	6.3	1.200	T.V. Damper	6.0
6DQ5	T-12	Beam Pent.	8JC	6.3	2.500	Horiz. Defl. Amplifier	26.4	175	25	125	110	5	5500	10500
6DQ6A	T-12	Beam Pent.	6AM	6.3	1.200	Horiz. Defl. Amplifier	18	6000 250	22.5 150 55	155 Ma. 5.5 1.5 20000 6600
6DQ6B	T-12	Beam Pent.	6AM	6.3	1.200	Horiz. Defl. Amplifier	18	250	22.5	150	65	1.8	18000	7300	4.4
6DR4	T-5½	Triode	6BG	6.3	0.150	A-F Amp.	1.2	100 250	1.0 2.0	0.5 1.2	80000 62500	1250 1600	100 100
6DR7	T-6½	Duotriode	9HF	6.3	0.900	Sect. 2 Vert. Defl. Amp. Sect. 1 Vert. Osc.	7.0 1.0	150 250	17.5 3	35 1.4	925 40000	6500 1600	6 64
6DS4	M-N	Triode	12AQ	6.3	0.135	VHF Amp.	1.0	110	130 [■]	6.5	7000	9000	63
6DS5	T-5½	Beam Pent.	7BZ	6.3	0.800	Power Amp.	8.8	200 250	180 [■] 270 [■]	200 200	34.5 27	3.5 3	28000 28000	6000 5800	6000 8000	2800 3600
6DT4	T-9	Diode	4CG	6.3	1.200	T.V. Damper	7.5
6DT5	T-6½	Beam Pent.	9HN	6.3	1.200	Vert. Defl. Amp.	9.0 9.0	250 250	16.5 250	44	1.5	6200
6DT6	T-5½	Gated Beam	7EN	6.3	0.300	Quad. F. M. Det. FM Det.	1.65	150	560 [■]	100	1.1	2.1	150000	615 Gr. #1 515 Gr. #3	-4.5 Gr. #1 -3.5 Gr. #3	#1 for 10 µA IB #3 for 10 µA IB
6DT6A	T-5½	Pentode	7EN	6.3	0.300	Quad. F. M. Det. FM Det.	1.7	150	560 [■]	100	1.55	1.8	150000	1350
6DT8	T-6½	Duotriode	9AJ	6.3	0.300	Amplifier	2.75	100 250	270 [■] 200 [■]	3.7 10	15000 10900	4000 5500	60 60
6DV4	M-N	Triode	12EA	6.3	0.135	UHF Osc.	1.0	75	100 [■]	10.5	3100	11500	35
6DW4	Novar T-9	Diode	9HP	6.3	1.200	T.V. Damper	8.5
6DW5	T-6½	Beam Pent.	9CK	6.3	1.200	Vert. Defl. Amp.	11	200	22.5	150	55	2.0	15000	5500	4.3
6DX4	T-5½	Triode	7DK	6.3	0.200	UHF Osc.	2.2	85	150 [■]	10.0	2700	11000	30
6DX8	T-6½	Tri. Pentode	9HX	6.3	0.720	Sync. Sep. Video Amp.	1.0 4.0	200 220	1.7 3.4 220	3.0 18 3.0	150000	4000 10000	65 36
6DY4	T-5½	Triode	7DK	6.3	0.125	UHF Osc.	1.5	90	180 [■]	10.4	11000	28

(1) See Frontal Section. (2) Design Maximum Values. (3) Has Special Mechanical and/or Life Characteristics. (4) Average Contact Potential Bias Developed Across Specified Grid Resistor. * Controlled Heater Warm-up Time (applies to parallel connections of types having a tapped heater.)
 † Maximum Signal. ‡ Filamentary Type. † Conversion Transconductance. ‡ Plate to Plate. ■ Cathode Resistor (ohms).

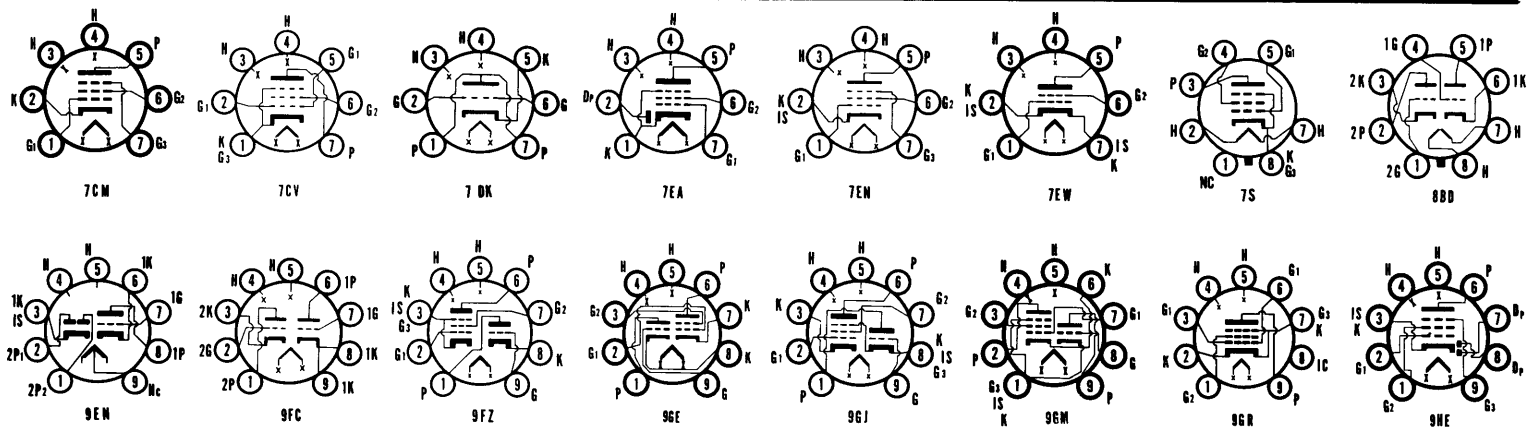

SYLVANIA TUBES

TYPE	CONSTRUCTION			EMITTER		USE	Plate Diss. Watts ²	Plate Volts	Negative Grid Volts	Screen Volts	Plate Current Ma.	Screen Current Ma.	Plate Resis. Ohms	Transcon-ductance Micros.	Amplifi-cation Factor	Ohms Load for Stated Power Output	Power Output Milli-watts
	Bulb Size or Style ¹	Class	Basing Diag.	Volts	Amps.												
6DY4A	T-5½	Triode	7DK	6.3	0.125	UHF Osc.	1.5	90	180 ^m	...	10.4	11000	28
6DY5	T-6½	Beam Pent.	9CV	6.3	0.800	S.T. A1 Amp. P.P. A1 Amp.	10	200	13.9	190	45	8.5	24000	7600	...	4000	4200
6DZ4	T-5½	Triode	7DK	6.3	0.225	UHF Osc.	2.3	80	2700 (Pl. Res.)	...	15.0	...	2000	6700	14
6DZ7	T-12	Double Beam Pent.	8JP	6.3	1.520	P.P. AB1 Amp. P.P. AB1 Amp.	13.2	400 300	11 120 ^m	250 250	40-100† 66-80†	4-13† 7-15†	9000 9000	18000 12000
6DZ8	T-6½	Tri. Beam Pent.	9EX	6.3	0.900	A-F Triode Volt. Amp. and Pent. Power Amp.	.825	120	1500 ^m	...	0.8	...	71000	1400	100
6E5	T-9	Electron Ray	6R	6.3	0.300	Indicator	...	100 250	(Series Plate Resistor 0.5 Meg. Target Current 1.0 Ma. Grid Bias = 3.3 for 90° Shadow.) (Series Plate Resistor 1.0 Meg. Target Current 4.0 Ma. Grid Bias = 8.0 for 90° Shadow.)
6EA5	T-5½	Tetrode	7EW	6.3	0.200	VHF Amp.	3.25	250	1.0	140	10	0.95	150000	8000
6EA7	T-9	Duotriode	8BD	6.3	1.050	Sect. 2 Vert. Amp. Sect. 1 Vert. Osc.	10	175	25	...	40	...	920	6000	5.5
6EA8	T-6½	Tri. Pentode	9AE	6.3*	0.450	Tri. VHF Amp. Pent. Amp.	3.0 3.1	150 125	56 ^m 1.0	...	18 12	...	5000 200000	8500 6400	40
6EB5	T-5½	Duodiode	6BT	6.3	0.300	Low Current Volt./Doubler
6EB8	T-6½	Tri. Pentode	9DX	6.3	0.750	A-F Amp. Video Amp.	1.0 5.0	250 200	2.0 68 ^m	...	2 25	...	37000 75000	2700 12500
6EH5	T-5½	Beam Pent.	7CV	6.3	1.200	S.T. A1 Amp.	5.5	110	62 ^m	115	42	11.5	11000	14600	...	3000	1400
6EH7	T-6½	Pentode	9AQ	6.3	0.300	VHF Amp.	2.7	200	2.0	90	12	4.5	50000	12500
6EH8	T-6½	Tri. Pentode	9JG	6.3*	0.450	VHF Osc. VHF Amp.	2.5 2.8	125 125	1.0 1.0	...	13.5 12	7500 6000	40
6EJ7	T-6½	Pentode	9AQ	6.3	0.300	VHF Amp.	2.7	200	2.5	200	10	4.1	35000	15000
6EL7	T-6½	Pentode	9AQ	6.3	0.300	VHF Amp.	3.0	170	150 ^m	170	10	2.6	...	9200
6EM5	T-6½	Beam Pent.	9HN	6.3	0.800	Vert. Defl. Amplifier	11	250	18	250	40	3	50000	5100	8.7
6EM7	T-9	Duotriode	8BD	6.3	0.925	Vert. Osc. Vert. Defl. A.	1.5 10	250 150	3.0 20	...	1.4 50	...	40000 750	1600 7200	64 5.4
6EQ7	T-6½	Diode Pent.	9LQ	6.3	0.300	Det. R-F Amp.	3.0	100	2.2 Meg†	100	9	3.5	250000	3800
6ER5	T-5½	Triode	7FP	6.3	0.180	VHF Amp.	2.2	200	1.2	0	10	0	8000	10500	80
6ES5	T-5½	Triode	7FP	6.3*	0.200	VHF Amp.	2.2	200	1.0	...	10	...	8000	9000	75
6ES8	T-6½	Duotriode	9AJ	6.3	0.365	VHF Amp.	1.98	90	1.2	...	15	12500
6ET7	T-6½	Duodi. Pent.	9LT	6.3	0.750	Video Amp.	5.0	200	100 ^m	150	25	5.5	60000	11500
6EU7	T-6½	Duotriode	9LS	6.3	0.300	A-F Amp.	1.2	100	1.0	...	0.5	...	80000	1250	100
6EU8	T-6½	Tri. Pentode	9JF	6.3	0.450	VHF Osc. VHF Amp.	3.1	150 125	56 ^m 1.0	...	18 12	...	5000 80000	8500 6400	40
6EV5	T-5½	Tetrode	7EW	6.3	0.200	VHF Amp.	3.25	250	1.0	80	11.5	0.9	150000	8800
6EV7	T-6½	Duotriode	9LP	6.3	0.600	Relay Control Tube	2.5	250	2.0	...	9.2	...	11500	5200	60
6EW6	T-5½	Pentode	7CM	6.3	0.400	VHF Amp.	3.1	125	56 ^m	125	11	3.2	200000	14000
6EW7	9-T9	Duotriode	9HF	6.3	0.900	Vert. Defl. Amp. Vert. Osc.	10	150	17.5	...	45	...	800	7500	6
6EX6	T-12	Beam Pent.	5BT	6.3	2.250	Horiz. Defl. Amp.	22	175	30	175	67	3.3	8500	7700

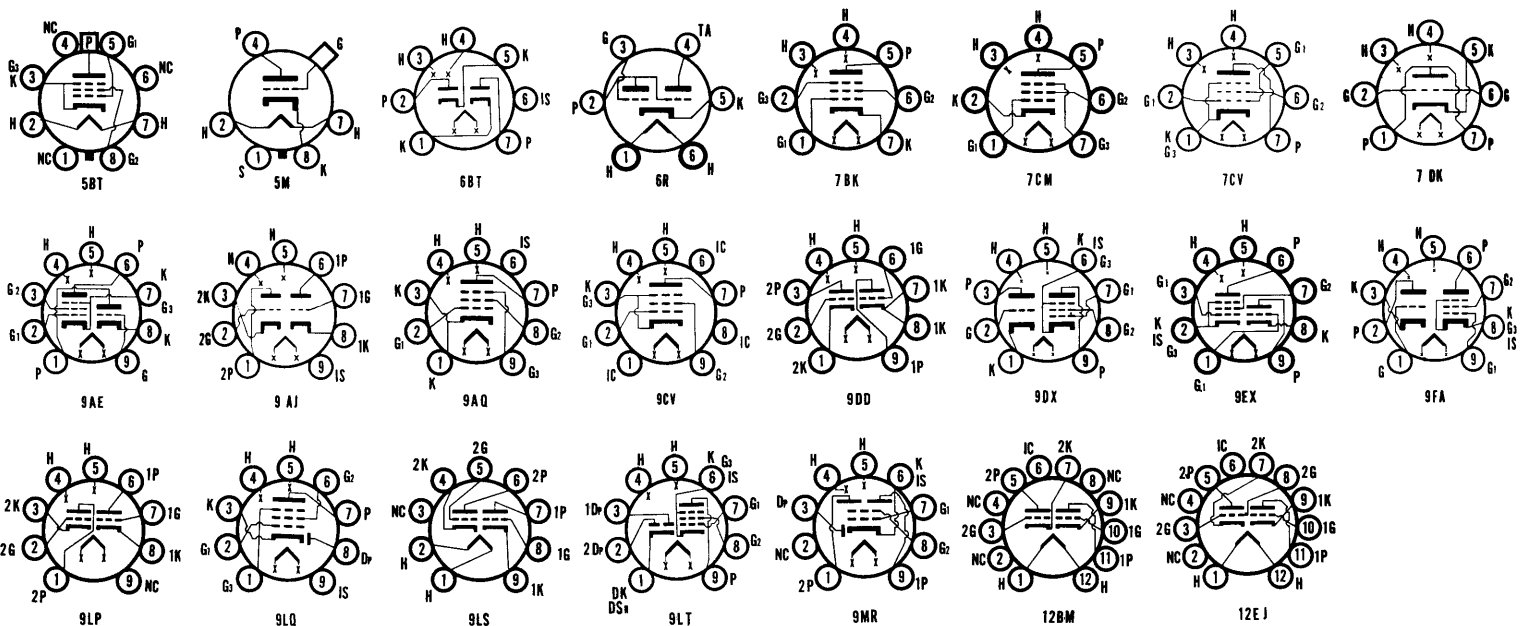

AVERAGE CHARACTERISTICS

TYPE	CONSTRUCTION			EMITTER		USE	Plate Diss. Watts ²	Plate Volts	Negative Grid Volts	Screen Volts	Plate Current Ma.	Screen Current Ma.	Plate Resis. Ohms	Transconductance Micros.	Amplification Factor	Ohms Load for Stated Power Output	Power Output Milli-watts
	Bulb Size or Style ¹	Class	Basing Diag.	Volts	Amps.												
6EY6	T-9	Beam Pent.	7S	6.3	0.680	Vert. Defl. Amp.	11	Max. 250	Peak 17.5	Positive Pulse 250	Plate Voltage = 2500	Volts. 44	3	60000	Max. D.C. Cathode Current = 60 Ma.	4400
6EZ5	T-9	Beam Pent.	7S	6.3	0.800	Vert. Defl. Amp.	12	Max. 250	Peak 20	Positive Pulse 250	Plate Voltage = 2500	Volts. 43	3.5	50000	Max. D.C. Cathode Current = 75 Ma.	4100
6EZ8	T-6½	Triple Triode	9KA	6.3	0.450	VHF Amp.	2.0	125	1.0	4.2	13600	4200	57	
6F5	Metal	Triode	5M	6.3	0.300	A-F Amp.	250	2.0	0.9	66000	1500	100	
6F5GT	T-9	Triode	5M	6.3	0.300	A-F Amp.	250	2.0	0.9	66000	1500	100	
6F6	Metal	Power Pent.	7S	6.3	0.700	Power Amp. S.T.A1 Amp.	12.1	250	16.5	250	34.0	6.5	80000	2500	7000	3200
6F6G	ST-14	Power Pent.	7S	6.3	0.700	P.P.A1 Amp.	285	20.0	285	38.0	7.0	78000	2550	7000	4800	
6F6GT	T-9	Power Pent.	7S	6.3	0.700	P.P.AB2 Amp.	315	24.0	285	62-80†	12-19.5†	(Current & Output, 2 Tubes)	50000	4100	10000†	11000
6FA7	T-6½	Diode Duo Plate Tet.	9MR	6.3	0.300	Frequency Divider	1.5	100	2.2 Meg ⁴	100	3.8	1.7	90000	3200
6FC7	T-6½	Duotriode	9DD	6.3	0.340	VHF Amp.	1.9	90	1.2	15	12000	
6FD6	T-5½	Pentode	7BK	6.3	0.330	R-F Amp.	12.6	2.2 Meg ⁴	12.6	1.4	0.5	500000	1450
6FD7	9-T9	Duotriode	9HF	6.3	0.925	Sect. 2 Vert. Defl. Amp.	10	Max. 150	Peak 17.5	Positive Pulse 40	Plate Voltage = 1500	Volts. 40	800	Max. D.C. Cathode Current = 50 Ma.	7500	6
6FE5	T-6½	Beam Pent.	8KB	6.3	1.200	Sect. 1 Vert. Osc. Amp.	1.5	250	3.0	1.4	40000	1600	64	
6FG5	T-5½	Shadow Grid Pent.	7GA	6.3	0.200	S.T.A1 Amp. P.P.A1 Amp.	14.5	130	120 [■]	130	82-94†	4-15†	1000	3500
6FG7	T-6½	Tri. Pentode	9GF	6.3	0.450	VHF Amp.	2.7	250	0.2	250	9	0.42	250000	9500	
6FH5	T-5½	Triode	7FP	6.3	0.200	VHF Osc./ Mixer	2.5	125	1.0	13	5700	7500	43	
6FH8	T-6½	Triode Triple Plate Tetrode	9KP	6.3	0.450	R-F Amp.	3.0	125	1.0	125	11	4	180000	6000	
6FJ7	Comp. T-9	Duotriode	12BM	6.3	0.900	Tri. Amp. 3 Plate Tet. Plate No. 1	1.7	100	1.0	7.9	7400	5400	40	
6FM7	Comp. T-9	Double Tri.	12EJ	6.3	1.050	Plate No. 2	2.3	100	1.0	50	1.6	0.3	2500	
6FM8	T-6½	Duodiode Tri.	9KR	6.3	0.450	Plate No. 3	0.3	100	1.0	50	0.4	0.3	70	
6FQ5	T-5½	Triode	7FP	6.3	0.180	Osc. Amp.	1.0	250	9.5	41	9000	2500	22.5	
6FQ5A	T-5½	Triode	7FP	6.3	0.180	Sect. 2 Vert. Defl. Amp.	10	Max. 250	Peak 9.5	Positive Pulse 41	Plate Voltage = 2500	Volts. 41	2000	Max. D.C. Cathode Current = 50 Ma.	7700	15.4
6FQ7	T-6½	Duotriode	9LP	6.3*	0.600	Sect. 1 Vert. Osc. Amp.	1.0	250	8.0	8	9000	2500	22.5	
6FR7	9-T9	Duotriode	9HF	6.3	0.925	Vert. Defl. Osc. Vert. Defl. Amp.	1.0	250	3	2.0	30000	2200	66.0	
6FS5	T-5½	Shadow Grid Beam Pent.	7GA	6.3	0.200	Det. Amp.	1.1	250	3	1.0	58000	1200	70	
6FV6	T-5½	Tetrode	7FQ	6.3	0.200	VHF Amp.	2.5	135	1.2	11.5	5500	11000	60	
6FV8	T-6½	Tri. Pentode	9FA	6.3*	0.450	VHF Amp.	2.5	135	1.2	8.9	6300	12000	74	
						General Purpose	4.0	90	0	10	6700	3000	20	
							250	8.0	9	7700	2600	20	
						Vert. Defl. Amplifier Vert. Osc.	10	Max. 150	Peak 20	Positive Pulse 50	Plate Voltage = 1500	Volts. 50	750	Max. D.C. Cathode Current = 50 Ma.	7200	5.4
						VHF Amp.	1.5	250	3.0	1.4	40000	1600	68	
						VHF Amp.	3.2	275	0.2	135	9	0.17	240000	10000	
						VHF Amp.	2.0	125	1.0	80	10	1.5	100000	8000	
						Vert. Osc. VHF Amp.	2.0	125	1.0	14	5000	8000	40	
							2.3	125	1.0	125	12	4.0	200000	6500	

(1) See Frontal Section. (2) Design Maximum Values. † Maximum Signal. (3) Has Special Mechanical and/or Life Characteristics. (4) Average Contact Potential Bias Developed Across Specified Grid Resistor. * Controlled Heater Warm-up Time (applies to parallel connections of types having a tapped heater.) ‡ Plate to Plate. ■ Cathode Resistor (ohms). ♦ Filamentary Type. † Conversion Transconductance.

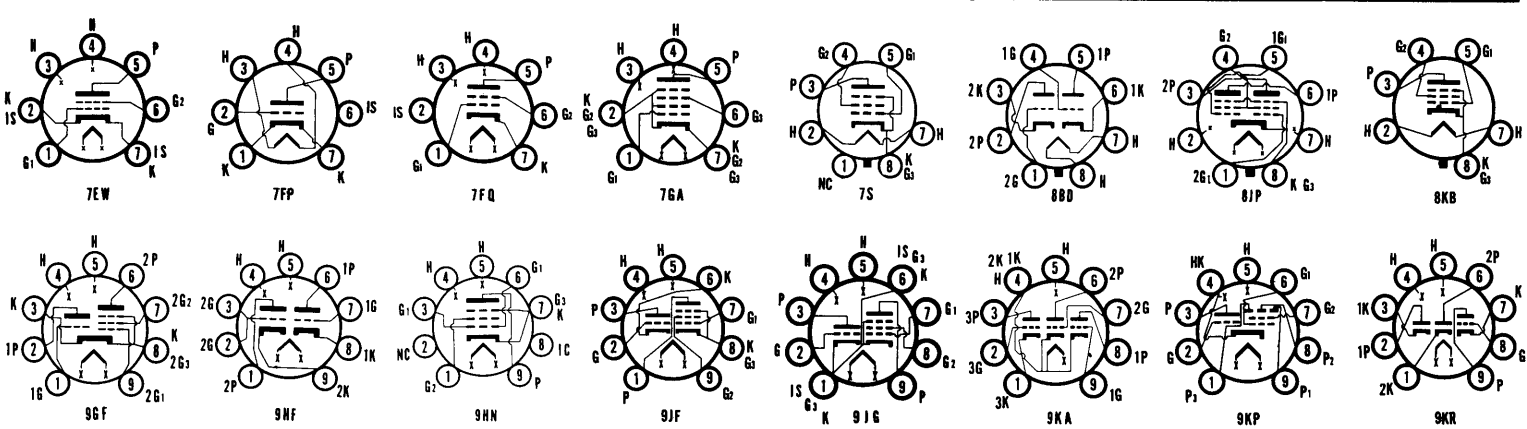

AVERAGE CHARACTERISTICS

TYPE	CONSTRUCTION			EMITTER		USE	Plate Diss. Watts ²	Plate Volts	Negative Grid Volts	Screen Volts	Plate Current Ma.	Screen Current Ma.	Plate Resis. Ohms	Transcon-ductance Micros.	Amplifi-cation Factor	Ohms Load for Stated Power Output	Power Output Milli-watts
	Bulb Size or Style ¹	Class	Basing Diag.	Volts	Amps.												
6GM5	9-T9	Beam Pent.	9MQ	6.3	0.800	A-F Pwr. Amp.	19	Characteristics and Ratings Same as Type 7591.									
6GM6	T-5½	Pentode	7CM	6.3	0.400	VHF Amp.	3.1	125	56 [■]	125	14	3.4	20000	13000
6GM8	T-6½	Duotriode	9AJ	6.3	0.330	R-F Amp. Osc. Mixer	.66	12.6	0.1 Meg ⁴	2.5	3400	4600
								12.6	0.22 Meg ⁴	1.0	8000	1300 ^A
								Oscillator Volts = 1.0 Volt. Plate Circuit Res. = 500 Ohms.									
6GN6	T-5½	Pentode	7FW	6.3*	0.300	R-F Amp.	3.3	100	68 [■]	100	10.8	4.4	25000	4300
								250	68 [■]	100	11	4.2	1 Meg.	4400
6GN8	T-6½	Tri. Pentode	9DX	6.3	0.750	Tri. Amp. Video Amp.	1.0	250	2.0	2.0	37000	2700	100
							5.0	200	100 [■]	150	25	2.0	60000	11500
6GQ7	T-6½	Triple Diode	9QM	6.3	0.450	AM Detector FM Ratio Det.	Max. Peak Inverse Plate Voltage = 330 Volts. Max. Peak Plate Current = 54 Ma.										
6GS8	T-6½	Duo. Pent.	9LW	6.3	0.300	Sync. Sep.	1.1	100	G3=10	67.5	6.0	IK = 6.1 Ma., IG ¹ = 100 μa.
								100	G3=0	67.5	2.0	3.6	IK = 7.7 Ma., IG ¹ = 100 μa.
6GT5	Novar T-12	Beam Pent.	9NZ	6.3	1.200	Horiz. Defl. Amplifier	17.5	Max. Peak Positive Pulse Plate Voltage = 6500 Volts. Max. D.C. Cathode Current = 175 Ma.									
								250	22.5	150	70	2.1	15000	7100
6GU5	T-5½	Pentode	7GA	6.3	0.220	VHF Amp.	3.0	135	0.4	135	9.0	0.25	670000	15000
6GU7	T-6½	Twin Triode	9LP	6.3*	0.600	Chroma Amp.	3.0	250	10.5	11.5	5500	3100	17
6GV5	Comp. T-12	Beam Pent.	12DR	6.3	1.200	Horiz. Defl. Amp.	17.5	Max. Peak Positive Pulse Plate Voltage = 6500 Volts. Max. D.C. Cathode Current = 175 Ma.									
								250	22.5	150	65	1.8	18000	7300	4.4
6GV7	T-6½	Triode Pent.	9KN	6.3	0.350	VHF Osc. VHF Mixer	T2.0	100	3	14	5.5 Ma/V	17	
							P2.0	125	1.5	125	10	3.1	11 Ma/V	50	
6GV8	T-6½	Triode Pent.	9LY	6.3	0.900	Vert. Defl. Osc. Vert. Defl. Amp.	0.5	100	0.8	5	7600	6500	50
							7.0	170	15	170	41	2.7	25000	7500	7
6GW5	T-5½	Triode	7GK	6.3	0.190	VHF Amp.	2.5	135	1	12.5	5800	15000	70
6GW6	T-12	Beam Pent.	6AM	6.3	1.200	Horiz. Defl. Amplifier	17.5	Max. Peak Positive Pulse Plate Voltage = 6500 Volts. Max. D.C. Cathode Current = 175 Ma.									
								250	22.5	150	70	2.1	15000	7100	G ² to G ¹ =4.4
6GW8	T-6½	Tri. Pentode	9LZ	6.3	0.700	A-F Amp. S.T.A1 Amp.	0.55	250	1.7	1.2	1600	1000	100
							9.9	250	170 [■]	250	36	5.5	45000	10000	7000	4200
6GX6	T-5½	Pentode	7EN	6.3*	0.450	Dual Control	1.7	150	180 [■]	100	3.7	3	140000	G ¹ 3700 G ² 750
6GY5	Comp. T-12	Beam Pent.	12DR	6.3	1.500	Horiz. Defl. Amp.	18	Max. Peak Positive Pulse Plate Voltage = 6500 Volts. Max. Cathode Current = 230 Ma.									
								130	20	130	50	1.75	11000	9100	4.7
6GY6	T-5½	Pentode	7EN	6.3*	0.450	Dual Control	1.7	150	180 [■]	100	3.7	3	140000	G ¹ 3700 G ² 750
6GY8	T-6½	Triple Triode	9MP	6.3	0.450	VHF Osc./ Amp./Mixer	2.0	125	220 [■]	4.5	14000	4500	63
6GZ5	T-5½	Beam Pent.	7CV	6.3	0.380	S.T. A1 Amp.	4.8	250	270 [■]	250	16	2.7	150000	8400	15000	1100
								250	270 [■]	250	16	2.7	150000	8400	15000	1800
								Bypassed Cathode Resistor. PO = 1.1 at 10% Dist. Unbypassed RK PO = 1.8 at 10% Dist.									
6H6, 6H6GT	T-9, Metal	Duodiode	7Q	6.3	0.300	Rectifier	117 A.C. Volts Per Plate, RMS, 8.0 Ma. Output Current Per Plate.									
6HA5	T-5½	Triode	7GM	6.3	0.180	VHF Amp.	2.6	135	1	11.5	14500	42
6HB5	Comp. T-12	Beam Pent.	12BJ	6.3	1.500	Horiz. Defl. Amp.	18	Max. Peak Positive Pulse Plate Voltage = 6000 Volts. Max. Cathode Current = 230 Ma.									
								130	20	130	50	1.75	11000	9100	4.7
6HB6	T-6½	Beam Pent.	9PU	6.3	0.760	Vert. Defl. Amplifier	10	Maximum Peak Positive Plate Voltage = 2500 Volts.									
								250	33 [■]	125	40	4.2	28000	24000
6HC8	9-T9	Tri. Pentode	9EX	6.3	1.200	Vert. Defl. Amplifier Vert. Osc.	1.0	250	18	250	38	3	55000	5100
							11	250	3	1.4	34000	2000	68
6HD5	Comp. T-12	Beam Pent.	12ES	6.3	2.250	Horiz. Defl. Amp.	24	Max. Peak Positive Pulse Plate Voltage = 7000 Volts. Max. Cathode Current = 280 Ma.									
								135	22	135	65	4	5000	10000	4.2

(1) See Frontal Section. (2) Design Maximum Values. † Maximum Signal. (3) Has Special Mechanical and/or Life Characteristics. (4) Average Contact Potential Bias Developed Across Specified Grid Resistor. * Controlled Heater Warm-up Time (applies to parallel connections of types having a tapped heater.) † Filamentary Type. † Plate to Plate. ■ Cathode Resistor (ohms).

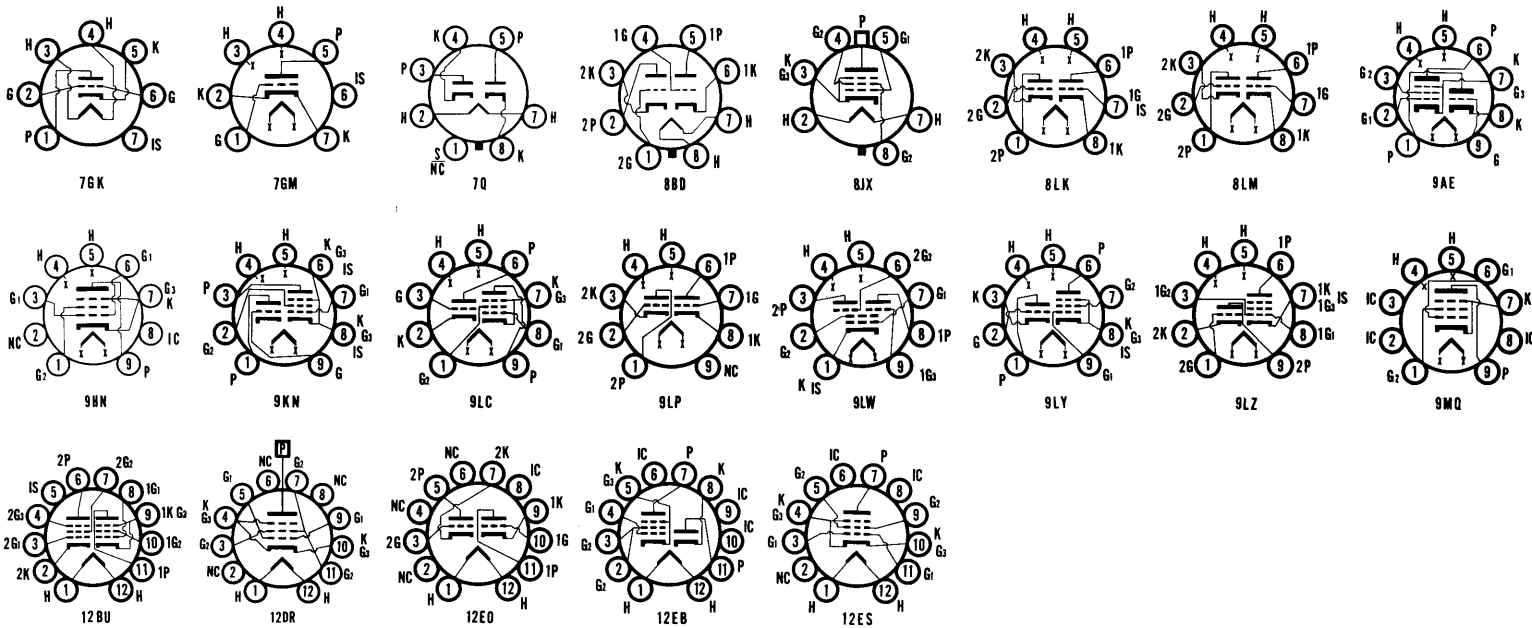

SYLVANIA TUBES

TYPE	CONSTRUCTION			EMITTER		USE	Plate Diss. Watts ²	Plate Volts	Negative Grid Volts	Screen Volts	Plate Current Ma.	Screen Current Ma.	Plate Resis. Ohms	Transconductance Micros.	Amplification Factor	Ohms Load for Stated Power Output	Power Output Milli-watts
	Bulb Size or Style ¹	Class	Basing Diag.	Volts	Amps.												
6HE5	Comp. T-9	Beam Pent.	12EY	6.3	0.800	Vert. Defl. Amp.	12	Max. 250	Peak Positive 20	Pulse Plate Voltage = 2500 Volts. 43	2500	3.5	50000	4100	75	75 Ma.
6HF5	Comp. T-12	Beam Pent.	12FB	6.3	2.250	Horiz. Defl. Amp.	28	Max. 175	Peak Positive 25	Pulse Plate Voltage = 7500 Volts. 125	7500	4.5	5600	11300	3	315 Ma.
6HF8	T-6½	Tri. Pentode	9DX	6.3	0.750	Gen. Purpose Video Amp.	1.0	200	2.0	125	4	7	17500	4000	70
6HG8	T-6½	Tri. Pentode	9MP	6.3	0.340	VHF Amp.	2.2	100	3.0	150	14	3.3	350000	6000	17
6HJ5	Comp. T-12	Beam Pent.	12ES	6.3	2.250	Horiz. Defl. Amp.	24	Max. 135	Peak Positive 22	Pulse Plate Voltage = 7000 Volts. 80	7000	5.5	5000	10000	4.2	280 Ma.
6HJ8	T-6½	Diode Pent.	9CY	6.3*	0.450	Video Det. T.V. I-F Amp.	3.2	125	56 ^m	125	11.5	3.6	200000	9300
6HK5	T-5½	Triode	7GM	6.3	0.190	VHF Amp.	2.3	135	1	12.5	5000	15000	75
6HL8	T-6½	Triode Pent.	9AE	6.3*	0.600	Tri. Sync. Sep. or Volt Amp. Pent. Video Amp.	2.5	125	1	12.5	5000	7000	40
6HM5	T-5½	Triode	7GM	6.3	0.185	VHF Amp.	2.2	135	1	12.5	14500	78
6HM6	T-6½	Pentode	9PM	6.3	0.300	T.V. I-F Amp.	2.5	125	56 ^m	125	13	3.2	156000	15000
6HQ6	T-5½	Pentode	6HQ6	6.3	0.300	VHF Amp.	2.4	125	56 ^m	125	15	3.8	220000	10500
6HR6	T-5½	Pentode	7BK	6.3*	0.450	FM I-F Amp.	3.0	200	68 ^m	115	13.2	4.3	500000	8500
6HS6	T-5½	Pentode	7BK	6.3*	0.450	I-F Amp.	3.0	150	68 ^m	75	8.8	2.8	500000	9500
6HS8	T-6½	Twin Pentode	9LW	6.3	0.300	AGC/Sync. Amplifier	1.1	100	g3=0V	67.5	4.4	IK = 8.5 Ma., Ig1 = 100 µa.
6HT6	T-6½	Pentode	9PM	6.3	0.300	T.V. I-F Amp.	2.5	125	56 ^m	125	15	4.0	143000	14000
6HU6	T-6½	Electron Ray	9GA	6.3	0.300	Indicator	0.6	250	(Control Voltage = 10 Volts (to Close Light Pattern)).								
6HW8	T-6½	Duo. Plate Sheet Beam	9NQ	6.3	0.300	Duo. Plate Sheet Beam	2.0	250	270 ^m	250	13	1.4	4000
6HZ6	T-5½	Pentode	7EN	6.3*	0.450	FM Det.	1.7	150	180 ^m	100	3.2	3.2	110000	3400
6HZ8	9-T9	Tri. Pentode	9DX	6.3	1.125	Gen. Pur. Tri. Video Amp.	1.0	200	2.0	3.5	4000	70
6J4 GB-6J4WA (3)	T-5½	Triode	7BQ	6.3	0.400	Amplifier	2.5	150	100 ^m	15.0	4500	12000	55
6J5 6J5GT	Metal T-9	Triode	6Q	6.3	0.300	Amplifier	2.75	250	8.0	9.0	7700	2600	20
6J6 6J6A 6J6WA (3)	T-5½	Duotriode	7BF	6.3 6.3*	0.450 0.450	VHF Osc. VHF Amp. Mixer	1.65	150	10.0	30.0	Push-Pull Class C Operation	7100 5300 1900 ^a	38	3500
6J7 6J7G 6J7GT	Metal ST-12 T-9	Pentode	7R 7R 7R	6.3	0.300	A-F Amp.	1.92	250	3.0	100	2.0	0.5	1.0 Meg <	1225
6J9	T-6½	Triple Tri.	10G	6.3*	0.450	R-F Amp. Osc. & Mixer	2.0	125	1	6.0	11000	5200	57
6J10	Comp. T-9	Double Pent.	12BT	6.3	0.950	FM Disc. Beam Amp.	122	200-400 ^m	100	0.49	9.8	100000	6500	330000	5000 4200
6J11	Comp. T-9	Duo. Pent.	12BW	6.3	0.800	T.V. I-F Amp.	3.1	125	56 ^m	125	11	3.8	200000	13000
6JA8	T-6½	Tri. Tetrode	9QF	6.3	0.750	Sync. Sep. Video Amp.	1.0	200	2	3.5	19000	3700	70
6JB6	Novar T-12	Pentode	9QL	6.3	1.200	Horiz. Defl. Amp.	17.5	250	22.5	150	70	2.1	15000	7100
6JC6	T-6½	Pentode	9PM	6.3	0.300	T.V. I-F Amp.	2.5	125	56 ^m	125	13	3.2	180000	15000

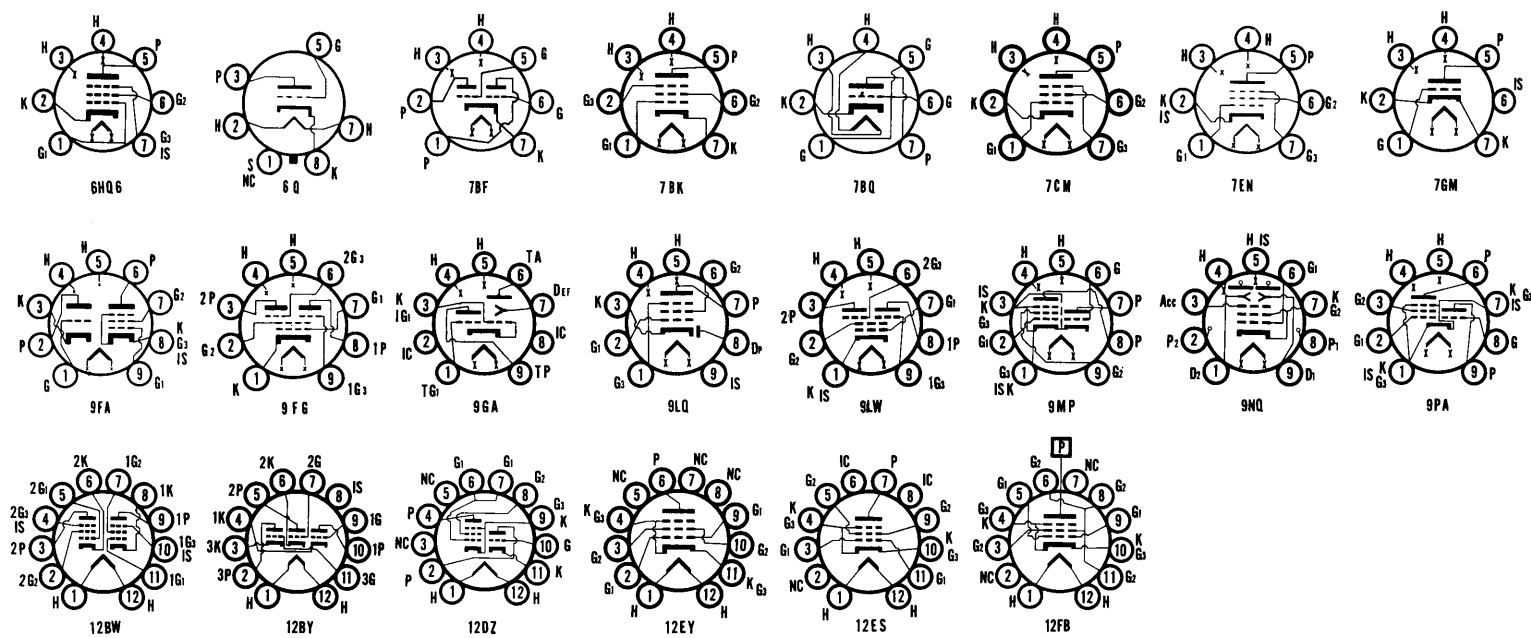

AVERAGE CHARACTERISTICS

TYPE	CONSTRUCTION			EMITTER		USE	Plate Diss. Watts ¹	Plate Volts	Negative Grid Volts	Screen Volts	Plate Current Ma.	Screen Current Ma.	Plate Resis. Ohms	Transconductance Micros.	Amplification Factor	Ohms Load for Stated Power Output	Power Output Milli-watts
	Bulb Size or Style ¹	Class	Basing Diag.	Volts	Amps.												
6JC8	T-6½	Tri. Pentode	9PA	6.3*	0.450	VHF Osc. VHF Amp.	1.7 2.3	125 125	1.0 1.0	125 125	12 9	2.2	6000 300000	6500 5500	40
6JD6	T-6½	Pentode	9PM	6.3	0.300	T.V. I-F Amp.	2.5	125	56 [■]	125	15	4.0	160000	14000
6JE6	Novar T-12	Pentode	9QL	6.3	2.500	Horiz. Defl. Amp.	24.0	175	25	125	115	5.0	5500	10500	3.3
6JE8	T-6½	Tri. Pentode	9DX	6.3	0.780	Gen. Purpose Video Amp.	1.0 4.0	200 250	2.0 82 [■]	170 170	4.5 22	4.0	140000	4200 12000	70
6JH6	T-5½	Pentode	7CM	6.3	0.300	T.V. I-F Amp.	2.3	125	56 [■]	125	14	3.6	260000	8000
6JK6	T-5½	Pentode	7CM	6.3	0.350	T.V. I-F Amp.	2.5	125	68 [■]	125	11.5	3.9	150000	18000
6JK8	T-6½	Duotriode	9AJ	6.3	0.400	FM Osc. FM Amp.	1.0 2.0	100 135	1.0 1.2	5.3 10	8000 5400	6800 13000	55 70
6JL6	T-5½	Pentode	7CM	6.3	0.350	T.V. I-F Amp.	2.5	125	68 [■]	60	12.5	4.0	120000	15500
6JL8	T-6½	Triode Pent.	9DX	6.3	0.750	Voltage Amp. Power Amp.	2.0 5.0	150 300	150 [■] 3.5	10 30	7.5	7500 60000	4700 11500	35	5000
6JN8	T-6½	Triode Pent.	9FA	6.3*	0.450	Oscillator Voltage Amp.	2.5 2.5	125 125	1 1	13.5 12.0	4.0	5400 200000	8500 7500	46
6JT8	T-9	Triode Pent.	9DX	6.3	0.725	Voltage Amp. Video Amp.	1.0 4.0	250 200	2 82 [■]	100	1.5 17.0	3.5	37000 50000	2700 20000	100
6JU8	T-6½	Quadruple Diode	9PQ	6.3	0.600	Color Det., FM Multiplex Det.
6JV8	T-6½	Triode Pent.	9DX	6.3*	0.600	Sync. Sep. Video Amp.	1.1 4.0	200 200	2 2.9	4 22	4	17500 150000	4000 10700	70
6JZ8	Comp. T-9	Triode Pent.	12DZ	6.3	0.600	Vert. Osc. Vert. Defl. Amp.	1.0 7.0	150 120	5 8	3.3 46	11300 11700	1900 7100	21.5
6K6GT	T-9	Power Pent.	7S	6.3	0.400	S.T. A1 Amp.	9.3	100 250 315	7.0 18.0 21.0	100 250 250	9.0 32.0 25.5	1.6 5.5 4.0	104000 68000 75000	1500 2300 2100	12000 7600 9000	350 3400 4500
6K7	Metal	Pentode	7R	6.3	0.300	R-F Amp.	3.0	100 250 250	1.0 3.0 3.0	100 100 125	9.5 7.0 10.5	2.7 1.7 2.6	150000 800000 600000	1650 1450 1650
6K8	Metal	Tri. Hexode	8K	6.3	0.300	Mixer Osc.	.825	250 100	3.0	100	2.5	6.0	600000	350 ⁴	(Hexode Section)		
6K11	Comp. T-9	Triple Triode	12BY	6.3*	0.600	Gen. Purpose	2.7 0.3 0.3	250 250 250	8.5 2.0 2.0	10.5 1.2 1.2	7700 62500 62500	2200 1600 1600	17 100 100
6KA8	T-6½	Triode Pent.	9PV	6.3*	0.600	Sync. Sep. AGC Amp.	1.1 2.0	200 150	2 180 [■]	100	4 4	2.8	17500 100000	4000 4400	70
6KD8	T-6½	Triode Pent.	9AE	6.3	0.400	VHF Osc. VHF Mixer	2.5 3.0	125 125	1 1	13.5 9.5	3.5	200000	7500 5000	40
6KE8	T-6½	Triode Pent.	9DC	6.3	0.400	VHF Osc. VHF Mixer	2.0 2.0	125 125	68 [■] 33 [■]	13 10	2.8	5000 125000	8000 12000	40
6KF8	T-6½	Double Pent.	9FG	6.3	0.300	Sync. Sep. AGC Amp.	1.1 1.1	100 100	G3=-10 G3=0	67.5 67.5	8.4 3.8	1k = 8.5 Ma. 1k = 9.5 Ma.
6KL8	T-6½	Diode Pent.	9LQ	6.3	0.300	Detector R-F I-F Amp. 3.0	100 100 2.2 Meg. ⁴	100 5.5	2.2	550000	4300
6KM8	T-6½	Diode Triple Plate Tetrode	9QG	6.3	0.300	Freq. Divider Key in Vibrato Circuits	1.0	100	2.2 Meg. ⁴	100	P1 2.3 P2 2.1 P3 2.1	3.3 3.8 3.8	120000 100000 100000	2000 1800 1800
6KN8	T-6½	Twin Triode	9AJ	6.3	0.400	VHF Amp.	2.2	110	1	16	2800	16000	45
6KR8	T-6½	Triode Pent.	9DX	6.3	0.750	Gen. Pur. Amp. Video Amp.	2.0 5.0	125 200	68 [■] 82 [■]	15 19.5	4400 6000	10400 20000	46

(1) See Frontal Section. (2) Design Maximum Values. (3) Has Special Mechanical and/or Life Characteristics. (4) Average Contact Potential Bias Developed Across Specified Grid Resistor. * Controlled Heater Warm-up Time (applies to parallel connections of types having a tapped heater.)
 † Maximum Signal. ‡ Filamentary Type. † Conversion Transconductance. ‡ Plate to Plate. † Cathode Resistor (ohms).

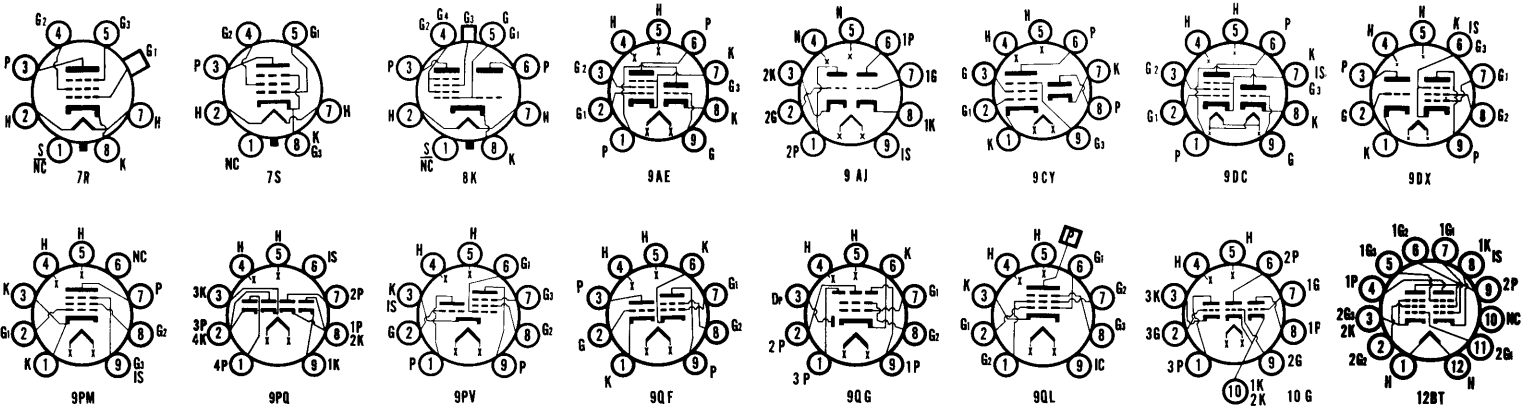

SYLVANIA TUBES

TYPE	CONSTRUCTION			EMITTER		USE	Plate Diss. Watts ²	Plate Volts	Negative Grid Volts	Screen Volts	Plate Current Ma.	Screen Current Ma.	Plate Res. Ohms	Transconductance Micros.	Amplification Factor	Ohms Load for Stated Power Output	Power Output Milli-watts
	Bulb Size or Style ¹	Class	Basing Diag.	Volts	Amps.												
6KS8	T-6½	Triode Pent.	9DX	6.3*	0.600	Gen. Pur. Amp. Video Amp.	1.1 3.75	200 150	2 150 150	4.0 20.0 4.5	17500 150000	4000 9500	70
6KT8	T-6½	Triode Pent.	9QP	6.3	0.600	Sync. Sep. I-F Amp.	1.0 2.5	250 125	2 1 125	1.8 12.0 4.5	31500 150000	3200 10000	100
6KU8	T-9	Double Diode Pentode	9LT	6.3	0.725	Phase Det. Video Amp. 4.0	Voltage Drop with Ib = 2 Ma. = 10 Volts.			 17 3.5	50000 20000
6KV8	T-6½	Triode Pent.	9DX	6.3	0.775	Video Amp.	5.0	200	68	125	20	4.0	75000	23000
6KZ8	T-6½	Triode Pent.	9FZ	6.3	0.450	VHF Osc. VHF Mixer	1.0 2.5	200 125	-2 1 125	4 13.5 4.0	17500 200000	400 8500	70 46
6L6	Metal	Beam Pent.	7S	6.3	0.900	S.T. A1 Amp. S.T. A1 Amp. P.P. A1 Amp. P.P. AB1 Amp. P.P. AB2 Amp.	20.9	250 350 270	14.0 18.0 17.5	250 250 270	72.0 54.0	5.0 2.5	22500 33000 23500	6000 5200 5700	2500 4200 5000	6500 10800 17500
6L6GB	T-12	Beam Pent.	7S	6.3	0.900	P.P. AB1 Amp. P.P. AB1 Amp. P.P. AB1 Amp.	30	360 360 450	22.5 22.5 37	270 270 400	88-132† 88-140† 116-210†	5-15† 5-11† 5.6-22†	6600† 3800† 5600†	26500 18000 55000
6L6GC	T-12	Beam Pent.	7S	6.3	0.900	P.P. AB1 Amp. P.P. AB1 Amp. P.P. AB1 Amp.	30	360 360 450	22.5 22.5 37	270 270 400	88-132† 88-140† 116-210†	5-15† 5-11† 5.6-22†	6600† 3800† 5600†	26500 18000 55000
6L7	Metal	Heptode	7T	6.3	0.300	Mixer Amp. Amplifier	1.65	250 250	6.0 3.0	150 100	3.3 5.3	9.2 6.5	1 Meg. < 600000	350* 1100	(G3 = Neg. 15 Volts) (G3 = Neg. 3.0 Volts)
6LB8	T-9	Triode Pent.	9DX	6.3	0.725	Voltage Amp. Video Amp.	2.0 4.0	125 200	68 82 100	13.0 17.0 3.5	6000 50000	5000 20000	30
6LC8	T-6½	Triode Pent.	9QY	6.3*	0.600	Sync. Sep. AGC Amp.	1.1 2.0	200 150	2 180 100	4.0 4.0 2.8	17500 100000	4000 4400	70
6M11	Comp. T-9	Pentode Duotriode	12CA	6.3	0.750	Gen. Purpose	3.1 2.25	125 125	56 120	11 8.0	3.4	200000 7250	13000 8000 58
6N7GT 6N7	T-9 Metal	Duotriode	8B	6.3	0.800	Power Amp. Driver	1.1	300 250 294	0.0 5.0 6.0	17.5-35† 6.0 7.0	Per Pl., Ct. B Sections Paralled	11300 11000	3100 3200	35 35	Zero Sig. (Class A Driver)	8000† 10000
6Q7 6Q7GT	Metal T-9	Duodiode Tri.	7V 7V	6.3	0.300	Det. Amp.	0.55	100 250	1.5 3.0	0.8 1.1	58000 58000	1200 1200	70 70
6Q11	Comp. T-9	Triple Triode	12BY	6.3*	0.600	Gen. Purpose	3.0 1.2 1.2	150 100 100	0 1.0 1.0	22 0.5 0.5	7000 80000 80000	2500 1250 1250	18 100 100
6R7	Metal	Duodiode Tri.	7V	6.3	0.300	Det. Amp.	2.75	250	9.0	9.5	8500	1900	16
6S4A	T-6½	Triode	9AC	6.3*	0.600	Vert. Defl. Amplifier	8.5	250	8.0	24	3700	4500	16.5
6SA7 6SA7GT 6SA7GT	Metal T-9 T-9	Heptode	8R 8AD 8AD	6.3	0.300	Converter	1.1	100 250	2.0 2.0	100 100	3.3 3.5	8.5 8.5	500000 1.0 Meg.	425* 450*
6SB7Y	Metal	Heptode	8R	6.3	0.300	Converter	2.2	250	1.5	100	4.0	8.5	880*
6SC7	Metal	Duotriode	8S	6.3	0.300	Amplifier	250	2.0	2.0	53000	1325	70	(Each Triode)
6SF5	Metal	Triode	6AB	6.3	0.300	A-F Amp.	250	2.0	0.9	66000	1500	100
6SF7	Metal	Diode Pent.	7AZ	6.3	0.300	Det. Amp.	3.85	100 250	1.0 1.0	100 100	12 12.4	3.4 3.3	200000 700000	1975 2050
6SG7	Metal	Pentode	8BK	6.3	0.300	R-F Amp.	3.3	100 250 250	1.0 1.0 2.5	100 125 150	8.2 11.8 9.2	3.2 4.4 3.4	250000 900000 1 Meg.	4100 4700 4000
6SH7	Metal	Pentode	8BK	6.3	0.300	R-F Amp.	3.3	100 250	1.0 1.0	100 150	5.3 10.8	2.1 4.1	350000 900000	4000 4900
6SJ7 6SJ7GT 6SJ7WGT (3) GB-6SJ7WGT(3)	Metal T-9 T-9 T-9	Pentode	8N 8N 8N 8N	6.3	0.300	A-F Amp.	2.8	100 250	3.0 3.0	100 100	2.9 3.0	0.9 0.8	700000 1.0 Meg <	1575 1650
6SK7 6SK7GT	Metal T-9	Pentode	8N 8N	6.3	0.300	R-F Amp.	4.4	100 250	1.0 3.0	100 100	13.0 9.2	4.0 2.6	120000 800000	2350 2000

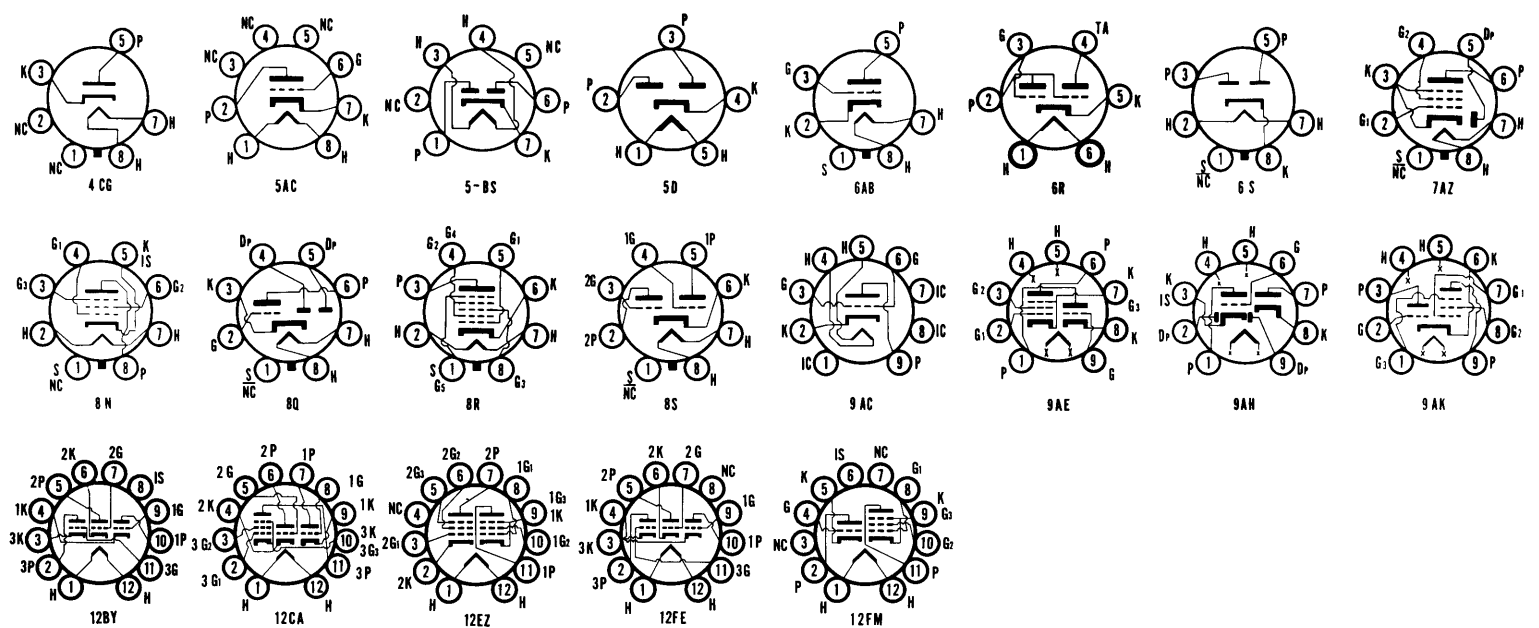

AVERAGE CHARACTERISTICS

TYPE	CONSTRUCTION			EMITTER		USE	Plate Diss. Watts ²	Plate Volts	Negative Grid Volts	Screen Volts	Plate Current Ma.	Screen Current Ma.	Plate Resis. Ohms	Transconductance Micros.	Amplification Factor	Ohms Load for Stated Power Output	Power Output Milli-watts
	Bulb Size or Style ¹	Class	Basing Diag.	Volts	Amps.												
6SL7GT GB-6SL7WGT(3)	T-9	Duotriode	8BD	6.3	0.300	Amplifier	1.1	250	2.0	2.3	...	44000	1600	70
6SN7GTB GB-6SN7WGT(3)	T-9	Duotriode	8BD	6.3	0.600	Amplifier	2.75	90 250	0 8.0	10.0 9.0	...	6700 7700	3000 2600	20 20
6SQ7 6SQ7GT	Metal T-9	Duodiode Tri.	8Q 8Q	6.3	0.300	Det. Amp.	0.55	250	2.0	1.1	...	85000	1175	100
6SR7	Metal	Duodiode Tri.	8Q	6.3	0.300	Det. Amp.	2.75	250	9.0	9.5	...	8500	1900	16
6SS7	Metal	Pentode	8N	6.3	0.150	R-F Amp.	2.5	100 250	1.0 3.0	100 100	12.2 9.0	3.1 2.0	120000 1000000	1950 1850
6T4	T-5½	Triode	7DK	6.3	0.225	UHF Osc.	3.85	80	150	18	...	1860	7000	13
6T8A	T-6½	Triple Diode Tri.	9E	6.3 6.3*	0.450 0.450	Det. Amp.	1.1	100 250	1.0 3.0	0.8 1.0	...	54000 58000	1300 1200	70 70
6T9	Comp. T-9	Triode Pent.	12FM	6.3	0.930	A-F Volt. Amp. A-F Pwr. Amp.	1.5 12.0	250 250	2 8 250	1.5 39.0	...	45000 100000	2100 6500	95
6T10	Comp. T-9	Double Pent.	12EZ	6.3	0.950	1. Power Amp. 2. FM Det.	10.0 1.7	250 150	8 560 [■]	250 100	39.0 1.3	7.0 2.1	100000 150000	6500 1000	5000	4200
6U5	T-9	Electron Ray	6R	6.3	0.300	Indicator	100 250	(Series Plate Res. 0.5 Meg., Target Current 1.0 Ma., Grid Bias—8.0 for 0° Shadow.) (Series Plate Res. 1.0 Meg., Target Current 4.0 Ma., Grid Bias—22.0 for 0° Shadow.)								
6U6GT	T-9	Beam Pent.	7S	6.3	0.750	Power Amp.	12.1	110 200	10.5 14.0	110 135	44.0 55.0	4.0 3.0	10000 20000	5600 6200	2000 3000	2000 5500
6U8A	T-6½	Tri. Pentode	9AE	6.3*	0.450	VHF Osc. VHF Amp.	2.5 3.0	125 125	1.0 1.0 110	13.5 9.5 3.5	5000 20000	7500 5000	40
6U10	Comp. T-9	Triple Triode	12FE	6.0*	0.600	Amp. Sec-1, 3 Amp. Sec-2	2.0 1.0	200 200	6.0 1.5	9.6 1.2	...	7700 61000	2300 1600	17.5 98
6V3A	T-6½	Diode	9BD	6.3	1.750	T.V. Damper	2.97	P.I.V. = 6000 Volts Abs. Max. D.C. Plate Current = 135 Ma. Max.									
6V6 6V6GT	Metal T-9	Beam Pent.	7S 7S	6.3 6.3	0.450 0.450	Power Amp. Class A1 Amplifier	13.2	180 250	8.5 12.5	180 250	29.0 45.0	3.0 4.5	50000 50000	3700 4100	5500 5000	2000 4500
6V6GTA	T-9		7S	6.3*	0.450	Class AB1 Amplifier		315 250	13.0 15.0	225 250	34.0 70-79†	2.2 5-13†	80000 (Class AB1 Two Tubes)	3750 (Class AB1 Two Tubes)	8500 10000†	5500 14000
6V8	T-6½	Triple Diode Triode	9AH	6.3	0.450	Det. Amp.	1.1	100 250	1.0 3.0	0.8 1.0	...	54000 58000	1300 1200	70 70
6W4GT 6W4GTA	T-9 T-9	Diode Diode	4CG 4CG	6.3 6.3	1.200 1.200	H-W Rect. T.V. Damper	3.85 4.0	350 A.C. Volts, RMS, 125 Ma. D.C. Output. Condenser Input to Filter. Max. Peak Inverse Plate Voltage = 3950 Volts. Max. D.C. Plate Current = 140 Ma.									
6W6GT	T-9	Beam Pent.	7S	6.3	1.200	Power Amp. Vert. Defl. Amplifier	11	110 200	7.5 180 [■]	110 125	49 46	4.0 2.2	13000 28000	8000 8000	2000 4000	2100 3800
6X4 GB-6X4WA (3)	T-5½	Duodiode	5BS	6.3	0.600	F-W Rect.	400 Volts RMS Per Plate, 55 Ma. D.C. Output Condenser Input to Filter.									
6X5GT 6X5WGT (3) GB-6X5WGT(3)	T-9 T-9	Duodiode	6S	6.3	0.600	F-W Rect.	325 A.C. Volts Per Plate, RMS, 70 Ma. Output Current. Condenser Input to Filter. 450 A.C. Volts Per Plate, RMS, 70 Ma. Output Current. Choke Input to Filter.									
6X8	T-6½	Triode Pentode	9AK	6.3	0.450	VHF Osc. VHF Amp.	1.7 2.3	125 125	1.0 1.0 125	12 9 2.2	6000 0.3 Meg.	5500	40
6Y6GA	T-12	Beam Pent.	7S	6.3	1.250	Power Amp.	13.75	135 200	13.5 14.0	135 135	58.0 61.0	3.5 2.2	9300 18300	7000 7100	2000 2600	3600 6000
6Z4/84	ST-12	Duodiode	5D	6.3	0.500	F-W Rect.	325 A.C. Volts Per Plate, RMS, 60 Ma. Output Current. Condenser Input to Filter. 450 A.C. Volts Per Plate, RMS, 60 Ma. Output Current. Choke Input to Filter.									
7A4/XXL	Lock-in	Triode	5AC	6.3	0.300	Amplifier	2.75	90 250	0.0 8.0	10.0 9.0	...	6700 7700	3000 2600	20 20

(1) See Frontal Section. (2) Design Maximum Values. (3) Has Special Mechanical and/or Life Characteristics. (4) Average Contact Potential Bias Developed Across Specified Grid Resistor. * Controlled Heater Warm-up Time (applies to parallel connections of types having a tapped heater.) † Maximum Signal. ‡ Filamentary Type. †† Plate to Plate. ††† Cathode Resistor (ohms).

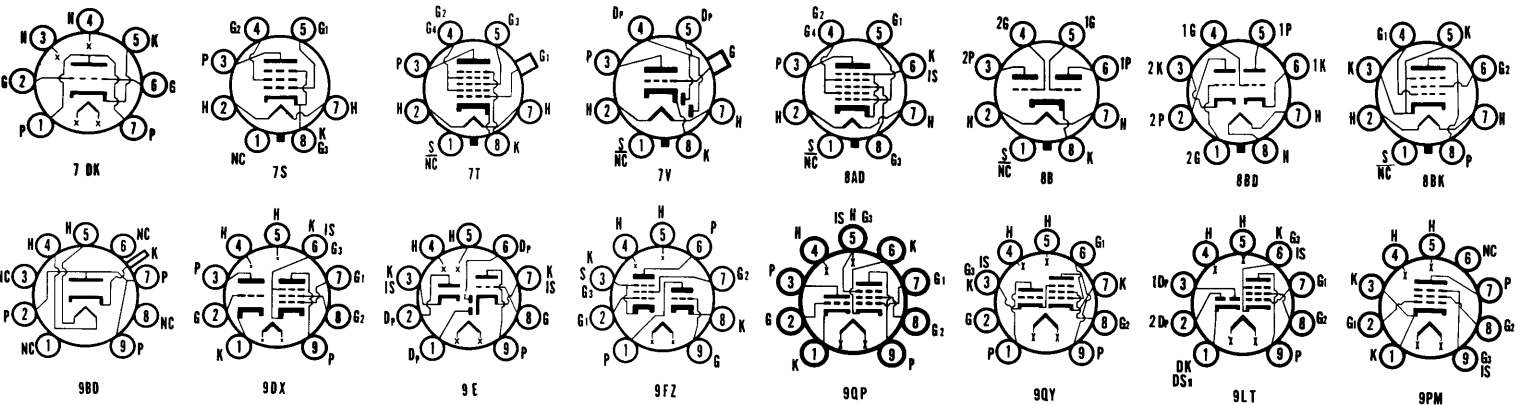

SYLVANIA TUBES

TYPE	CONSTRUCTION			EMITTER		USE	Plate Diss. Watts ²	Plate Volts	Negative Grid Volts	Screen Volts	Plate Current Ma.	Screen Current Ma.	Plate Resis. Ohms	Transconductance Micros.	Amplification Factor	Ohms Load for Stated Power Output	Power Output Milli-watts
	Bulb Size or Style ¹	Class	Biasing Diag.	Volts	Amps.												
7A5	Lock-in	Beam Pent.	6AA	6.3	0.750	Power Amp.	6.0	110 125	7.5 9.0	110 125	40.0 44.0	3.0 3.3	16000 17000	5800 6000	2500 2700	1500 2200
7A6	Lock-in	Duodiode	7DX	6.3	0.150	Det. Rect.	150 A.C. Volts Per Plate, RMS, 8 Ma. Current Output Per Plate.									
7A7	Lock-in	Pentode	8V	6.3	0.300	R-F Amp.	4.4	100 250	1.0 3.0	100 100	13.0 9.2	4.0 2.6	120000 800000	2350 2000
7A8	Lock-in	Octode	8U	6.3	0.150	Converter	1.1	100 250	3.0 3.0	75 100	1.8 3.0	2.7 3.2	650000 700000	375 ^A 550 ^A	(Ga = 100 V., 2.8 Ma.) (Ga = 250 V thru 20K Ohms.)		
7AF7	Lock-in	Duotriode	8AC	6.3	0.300	Amplifier (per unit)	2.75	100 100 250	0 3.0 10	10.8 5.0 9.0	6500 8400 7600	2600 1900 2100	17 16 16
7AG7	Lock-in	Pentode	8V	6.3	0.150	R-F Amp.	2.2	250	250 ^M	250	6.0	2.0	1.0 Meg	< 4200
7AK7 GB-7AK7 (3)	Lock-in	Pentode	8V	6.3	0.800	R-F Amp.	9.35	150 150 150	0 11 0	90 90 90	40 2.5 Max. 2.0 Max.	21 0.45 60 Max.	11500	6000
7AU7	T-6½	Duotriode	9A	7.0/ 3.5*	0.300/ 0.600	Amplifier	3.0	Characteristics Same as Type 12AU7A. (7AU7 Designed for Series String Receivers.)									
7B4	Lock-in	Triode	5AC	6.3	0.300	Amplifier	100 250	1.0 2.0	0.4 0.9	85000 66000	1150 1500	100 100
7B5	Lock-in	Power Pent.	6AE	6.3	0.400	Power Amp.	9.35	100 250 315	7.0 18.0 21.0	100 250 250	9.0 32.0 25.5	1.6 5.5 4.0	104000 68000 75000	1500 2300 2100	12000 7600 9000	350 3400 4500
7B6	Lock-in	Duodiode Tri.	8W	6.3	0.300	Det. Amp.	0.55	100 250	1.0 2.0	0.4 0.9	110000 91000	900 1100	100 100
7B7	Lock-in	Pentode	8V	6.3	0.150	R-F Amp.	2.47	100 250	3.0 3.0	100 100	8.2 8.5	1.8 1.7	300000 750000	1675 1750
7B8	Lock-in	Heptode	8X	6.3	0.300	Converter	1.1	100 250	1.5 3.0	50 100	1.1 3.5	1.3 2.7	600000 360000	360 ^A 550 ^A	(Ga = 100 V., 2.0 Ma.)		
7C5	Lock-in	Beam Pent.	6AA	6.3	0.450	Power Amp. Class A1 Class AB1	13.2	180 250 315 250 285	8.5 12.5 13.0 15.0 19.0	180 250 225 250 285	29.0 45.0 34.0 70-79† 70-92†	3.0 4.5 2.2 5-13† 4-13.5†	58000 52000 77000 (Class AB1 Two Tubes) (Class AB1 Two Tubes)	3700 4100 3750 10000† 8000†	5500 5000 8500 10000† 10000†	2000 4500 5500 10000 14000
7C6	Lock-in	Duodiode Tri.	8W	6.3	0.150	Det. Amp.	0.66	100 250	0.0 1.0	1.0 1.3	100000 100000	850 1000	85 100
7C7	Lock-in	Pentode	8V	6.3	0.150	R-F Amp.	1.1	100 250	3.0 3.0	100 100	1.8 2.0	0.4 0.5	1.2 Meg. 2.0 Meg.	1225 1300
7DJ8	T-6½	Duotriode	9AJ	7.0	0.300	VHF Amp.	2.2	90	1.3	15	12500	33
7ES8	T-6½	Duotriode	9AJ	7.2	0.300	VHF Amp.	1.8	90	1.4	15	2500	12500
7EY6	T-9	Beam Pent.	7S	7.2*	0.600	Vert. Defl. Amplifier	11	Max. Peak Positive Pulse Plate Voltage = 2500 Volts. Max. D.C. Cathode Current = 60 Ma. Characteristics Same as Type 6EY6.									
7F7	Lock-in	Duotriode	8AC	6.3	0.300	A-F Amp.	1.1	100 250	1.0 2.0	0.65 2.3	62000 44000	1125 1600	70 70
7F8	Lock-in	Duotriode	8BW	6.3	0.300	Osc. Amp.	3.85	250	500 ^M	6.0	3300	48
GB-7F8W (3)	Lock-in	Duotriode	8BW	6.3	0.300	Osc. Amp.	3.5	250	200 ^M	11.0	5200	50
7FC7	T-6½	Duotriode	9DD	7.2	0.300	VHF Amp.	1.9	Characteristics Same as Type 6FC7. (7FC7 Designed for Series String Receivers.)									
7GV7	T-6½	Triode Pent.	9KN	7.4	0.300	VHF Osc. VHF Mixer	2.0 2.0	Characteristics Same as Type 6GV7.									
7H7	Lock-in	Pentode	8V	6.3	0.300	R-F Amp.	2.75	100 250	1.5 180 ^M	100 150	7.5 10.0	2.6 3.2	350000 800000	4000 4000
7HG8	T-6½	Tri. Pentode	9MP	7.2	0.300	VHF Amp.	2.2	Characteristics Same as Type 6HG8. (7HG8 Designed for Series String Receivers.)									
7J7	Lock-in	Tri. Heptode	8BL	6.3	0.300	Hep. Mixer Tri. Osc.	0.55 1.74	100 250 100	3.0 2.0 0.05 Meg.	100 100	1.5 1.4 3.2	2.6 2.8 1.5 Meg.	50000 (Triode Grid Current 0.3 Ma.)	280 ^A 290 ^A

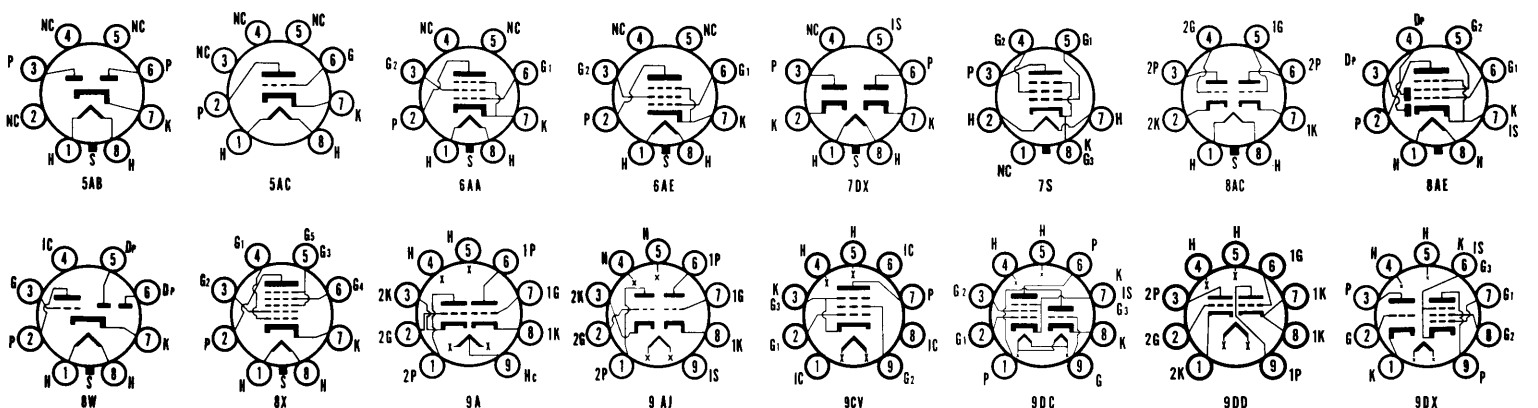

AVERAGE CHARACTERISTICS

TYPE	CONSTRUCTION			EMITTER		USE	Plate Diss. Watts [†]	Plate Volts	Negative Grid Volts	Screen Volts	Plate Current Ma.	Screen Current Ma.	Plate Res. Ohms	Transconductance Micros.	Amplification Factor	Ohms Load for Stated Power Output	Power Output Milli-watts
	Bulb Size or Style ¹	Class	Basing Diag.	Volts	Amps.												
7K7	Lock-in	Duodiode Tri.	8BF	6.3	0.300	Det. Amp.	1.1	250	2.0	...	2.3	...	44000	1600	70
7L7	Lock-in	Pentode	8V	6.3	0.300	R-F Amp.	4.4	100 250	1.0 1.5	100 100	5.5 4.5	2.4 1.5	100000 1.0 Meg.	3000 3100
7N7	Lock-in	Duotriode	8AC	6.3	0.600	Amplifier	2.75	90 250	0.0 8.0	...	10.0 9.0	...	6700 7700	3000 2600	20 20
7Q7	Lock-in	Heptode	8AL	6.3	0.300	Converter	1.1	100 250	2.0 2.0	100 100	3.3 3.5	8.5 8.5	500000 1.0 Meg.	525 [‡] 550 [‡]	(Osc. Grid Resistor 20000) (Osc. Grid Current 0.5 Ma.)
7R7	Lock-in	Duodi. Pent.	8AE	6.3	0.300	Det. Amp.	2.2	100 100 250 250	2.0 1.0 2.0 1.0	100 100 100 100	3.4 5.5 3.5 5.7	1.0 2.2 1.0 2.1	500000 350000 1800000 1000000	2100 3000 2200 3200
7S7	Lock-in	Tri. Heptode	8BL	6.3	0.300	Hep. Mixer Tri. Osc.	0.66	100 250 100 250	2.0 2.0 0.05 Meg. 0.05 Meg.	100 100	1.9 1.8 3.0 5.0	3.0 3.0	500000 1.25 Meg.	500 [‡] 525 [‡]
7V7	Lock-in	Pentode	8V	6.3	0.450	R-F Amp.	4.4	300	160 [■]	150	10.0	3.9	300000	5800
7W7	Lock-in	Pentode	8BJ	6.3	0.450	R-F Amp.	4.4	Characteristics Same as Type 7V7, Except Capacitances.									
7X7	Lock-in	Duodiode Tri.	8BZ	6.3	0.300	Det. Amp.	0.55	100 250	0 1.0	...	1.2 1.9	...	85000 67000	1000 1500	85 100
7Y4	Lock-in	Duodiode	5AB	6.3	0.500	F-W Rect.	...	325 A.C. Volts Per Plate, RMS, 70 Ma. Output Current. Condenser Input to Filter. Choke Input to Filter.									
7Z4	Lock-in	Duodiode	5AB	6.3	0.900	F-W Rect.	...	325 A.C. Volts Per Plate, RMS, 100 Ma. Output Current. Condenser Input to Filter. Choke Input to Filter.									
8A8	T-6½	Triode Pent.	9DC	8.4	0.300	VHF Osc. VHF Amp.	5.5 8.25	Characteristics Same as Type 9A8.									
8AU8	T-6½	Tri. Pentode	9DX	8.4*	0.450	Tri. Amp. Pent. Amp.	2.75 3.3	Characteristics Same as Type 6AU8. (8AU8 and 8AU8A Designed for Series String Operation.)									
8AU8A	T-6½	Tri. Pentode	9DX	8.4*	0.450	Tri. Amp. Pent. Amp.	2.75 3.3	Characteristics Same as Type 6AU8. (8AU8A Designed for Series String Receivers.)									
8AW8A	T-6½	Tri. Pentode	9DX	8.4*	0.450	Sync. Sep. Video Amp.	1.1 3.57	Characteristics Same as Type 6AW8A. (8AW8A Designed for Series String Receivers.)									
8B10	Comp. T-9	Duodiode Duotriode	12BF	6.3*	0.600	Horiz. Phase Det./Osc.	3.0	Characteristics Same as Type 6B10. (8B10 Designed for Series String Receivers.)									
8BA8A	T-6½	Tri. Pentode	9DX	8.4*	0.450	Sync. Sep. Video Amp.	2.2 3.57	Characteristics Same as Type 6BA8A. (8BA8A Designed for Series String Receivers.)									
8BH8	T-6½	Tri. Pentode	9DX	8.4*	0.450	Tri. Amp. Pent. Amp.	2.75 3.3	Characteristics Same as Type 6BH8. (8BH8 Designed for Series String Receivers.)									
8BN8	T-6½	Duodiode Tri.	9ER	8.4*	0.450	Amplifier	1.65	Characteristics Same as Type 6BN8. (8BN8 Designed for Series String Receivers.)									
8BQ5	T-6½	Beam Pent.	9CV	8.0*	0.600	P.P.AB1 Amp.	13.2	Characteristics Same as Type 6BQ5. (8BQ5 Designed for Series String Receivers.)									
8CG7	T-6½	Duotriode	9AJ	8.4*	0.450	Amplifier	3.85	Characteristics Same as Type 6CG7. (8CG7 Designed for Series String Receivers.)									
8CM7	T-6½	Duotriode	9ES	8.4*	0.450	Vert. Osc. Vert. Defl. A.	1.37 5.5	Characteristics Same as Type 6CM7. (8CM7 Designed for Series String Receivers.)									
8CN7	T-6½	Duodiode Tri.	9EN	8.4/ 4.2*	0.225/ 0.450	Det. Amp.	1.1	Characteristics Same as Type 6CN7. (8CN7 Designed for Series String Receivers.)									
8CS7	T-6½	Duotriode	9EF	8.4*	0.450	Vert. Osc. Vert. Defl. A.	1.37 5.5	Characteristics Same as Type 6CS7. (8CS7 Designed for Series String Receivers.)									
8CW5	T-6½	Beam Pent.	9CV	8.0*	0.600	A-F Pwr. Amp.	13	Characteristics Same as Type 6CW5. (8CW5 Designed for Series String Receivers.)									
8CX8	T-6½	Tri. Pentode	9DX	8.0*	0.600	Tri. Amp. Video Amp.	2.0 5.0	Characteristics Same as Type 6CX8. (8CX8 Designed for Series String Receivers.)									
8CY7	T-6½	Duotriode	9LG	7.9*	0.600	Vert. Osc. Vert. Defl. A.	1.0 5.5	Characteristics Same as Type 6CY7. (8CY7 Designed for Series String Receivers.)									
8EB8	T-6½	Tri. Pentode	9DX	8.0*	0.600	A-F Amp. Video Amp.	1.0 5.0	Characteristics Same as Type 6EB8. (8EB8 Designed for Series String Receivers.)									

(1) See Frontal Section. (2) Design Maximum Values. (3) Has Special Mechanical and/or Life Characteristics. (4) Average Contact Potential Bias Developed Across Specified Grid Resistor. * Controlled Heater Warm-up Time (applies to parallel connections of types having a tapped heater.)
[†] Maximum Signal. [‡] Filamentary Type. [▲] Conversion Transconductance. [¶] Plate to Plate. [■] Cathode Resistor (ohms).

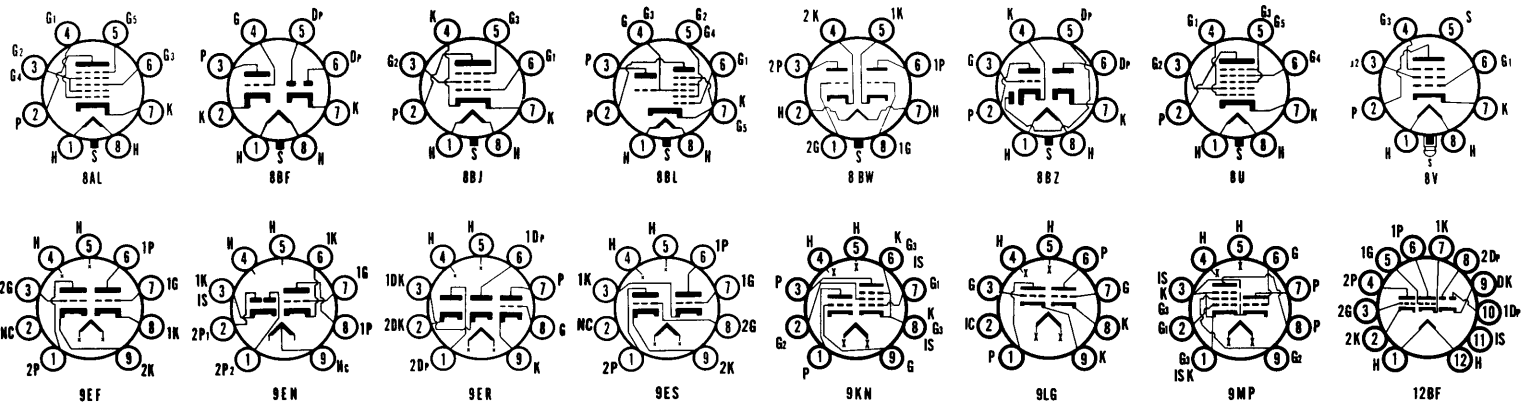

SYLVANIA TUBES

TYPE	CONSTRUCTION			EMITTER		USE	Plate Diss. Watts ²	Plate Volts	Negative Grid Volts	Screen Volts	Plate Current Ma.	Screen Current Ma.	Plate Resis. Ohms	Transcon-ductance Micros.	Amplifi-cation Factor	Ohms Load for Stated Power Output	Power Output Milli-watts
	Bulb Size or Style ¹	Class	Basing Diag.	Volts	Amps.												
8EM5	T-6½	Beam Pent.	9HN	8.4*	0.600	Vert. Defl. Amplifier	11	Characteristics Same as Type 6EM5. (8EM5 Designed for Series String Receivers.)									
8ET7	T-6½	Duodiode Pentode	9LT	8.0*	0.600	Horiz. Phase Det. Video A.	5.0	Characteristics Same as Type 6ET7. (8ET7 Designed for Series String Receivers.)									
8FQ7	T-6½	Duotriode	9LP	8.4*	0.450	Gen. Purpose	4.0	Characteristics Same as Type 6FQ7. (8FQ7 Designed for Series String Receivers.)									
8GN8	T-6½	Tri. Pentode	9DX	8.0*	0.600	Triode Amp. Video Amp.	1.0 5.0	Characteristics Same as Type 6GN8. (8GN8 Designed for Series String Receivers.)									
8HG8	T-6½	Tri. Pentode	9MP	8.0*	0.300	VHF Amp.	1.6 2.2	Characteristics Same as Type 6HG8. (8HG8 Designed for Series String Receivers.)									
8JE8	T-6½	Tri. Pentode	9DX	8.2*	0.600	Gen. Purpose Video Amp.	1.0 4.0	Characteristics Same as Type 6JE8. (8JE8 Designed for Series String Receivers.)									
8JK8	T-6½	Duotriode	9AJ	8.4*	0.300	FM Osc. FM Amp.	1.0 2.0	100 130	1.0 1.2	...	5.3 10	...	8000 5400	1800 13000	55 70
8JL8	T-6½	Triode Pent.	9DX	8.0*	0.600	Voltage Amp. Power Amp.	2.0 5.0	Characteristics Same as Type 6JL8. (8JL8 Designed for Series String Receivers.)									
8JT8	T-9	Triode Pent.	9DX	7.7*	0.600	Voltage Amp. Power Amp.	1.0 4.0	Characteristics Same as Type 6JT8. (8JT8 Designed for Series String Receivers.)									
8JV8	T-6½	Triode Pent.	9DX	8.5*	0.450	Sync. Sep. Video Amp.	1.1 4.0	Characteristics Same as Type 6JV8. (8JV8 Designed for Series String Receivers.)									
8KA8	T-6½	Triode Pent.	9PV	8.4*	0.450	Sync. Sep. AGC Amp.	1.1 2.0	Characteristics Same as Type 6KA8. (8KA8 Designed for Series String Receivers.)									
8KS8	T-6½	Triode Pent.	9DX	8.4*	0.450	Gen. Pur. Amp. Video Amp.	1.1 3.75	Characteristics Same as Type 6KS8. (8KS8 Designed for Series String Receivers.)									
8LC8	T-6½	Triode Pent.	9QY	8.4*	0.450	Sync. Sep. AGC Amp.	1.1 2.0	Characteristics Same as Type 6LC8. (8LC8 Designed for Series String Receivers.)									
9A8	T-6½	Tri. Pentode	9DC	9.0	0.300	VHF Osc. VHF Amp.	5.5 8.25	Characteristics Same as Type 6B8L.									
9AU7	T-6½	Duotriode	9A	9.4/ 4.7*	0.225/ 0.450	Amplifier	3.0	Characteristics Same as Type 7AU7. (9AU7 Designed for Series String Receivers.)									
9BR7	T-6½	Duodiode Tri.	9CF	4.7* 9.4*	0.600 0.300	Det. Amp.	2.75	250	200 [■]	...	10	...	10900	4000	60
9BR8	T-6½	Tri. Pentode	9FA	9.45	0.300	VHF Osc. VHF Amp.	2.97 3.0	150 250	56 [■] 68 [■]	...	18 10	...	5000 400000	8500 5200	40
9CG8A	T-6½	Triode Pent.	9GF	9.5*	0.300	Osc. Mixer	1.7 2.3	Characteristics Same as Type 6CG8A. (9CG8A Designed for Series String Receivers.)									
9CL8	T-6½	Tri. Tetrode	9FX	9.5*	0.300	VHF Osc. VHF Amp.	2.97 3.0	Characteristics Same as Type 6CL8. (9CL8 Designed for Series String Receivers.)									
9DZ8	T-6½	Triode Beam Pent.	9EX	9.0	0.600	A-F Voltage Amp. and Power Amp.	.82 7.15	Characteristics Same as Type 6DZ8. (9DZ8 Designed for Series String Receivers.)									
9EA8	T-6½	Triode Pent.	9AE	9.5*	0.300	Tri. VHF Amp. Pent. Amp.	3.0 3.1	Characteristics Same as Type 6EA8. (9EA8 Designed for Series String Receivers.)									
9EF6	T-9	Beam Pent.	7S	9.4*	0.600	Vert. Defl. Amplifier	11	Characteristics Same as Type 6EF6. (9EF6 Designed for Series String Receivers.)									
9GV8	T-6½	Triode Pent.	9LY	9.5*	0.600	Vert. Defl. Osc. Ver. Defl. Amp.	0.5 7.0	Characteristics Same as Type 6GV8. (9GV8 Designed for Series String Receivers.)									
9KZ8	T-6½	Triode Pent.	9FZ	9.45*	0.300	VHF Osc. VHF Amp.	2.5 2.5	Characteristics Same as Type 6KZ8. (9KZ8 Designed for Series String Receivers.)									
9U8A	T-6½	Tri. Pentode	9AE	9.45*	0.300	VHF Osc. VHF Amp.	2.5 3.0	Characteristics Same as Type 6U8. (9U8A Designed for Series String Receivers.)									
9X8	T-6½	Tri. Pentode	9AK	9.5*	0.300	VHF Osc. VHF Amp.	1.65 2.2	Characteristics Same as Type 6X8. (9X8 Designed for Series String Receivers.)									
10AL11	Comp. T-9	Duo. Pentode	12BU	9.8*	0.600	FM Det. ST A1 Amp.	1.7 10	Characteristics Same as Type 6AL11. (10AL11 Designed for Series String Receivers.)									
10BQ5	T-6½	Power Pent.	9CV	10.6*	0.450	A-F Pwr. Amp.	12	Characteristics Same as Type 6BQ5. (10BQ5 Designed for Series String Receivers.)									

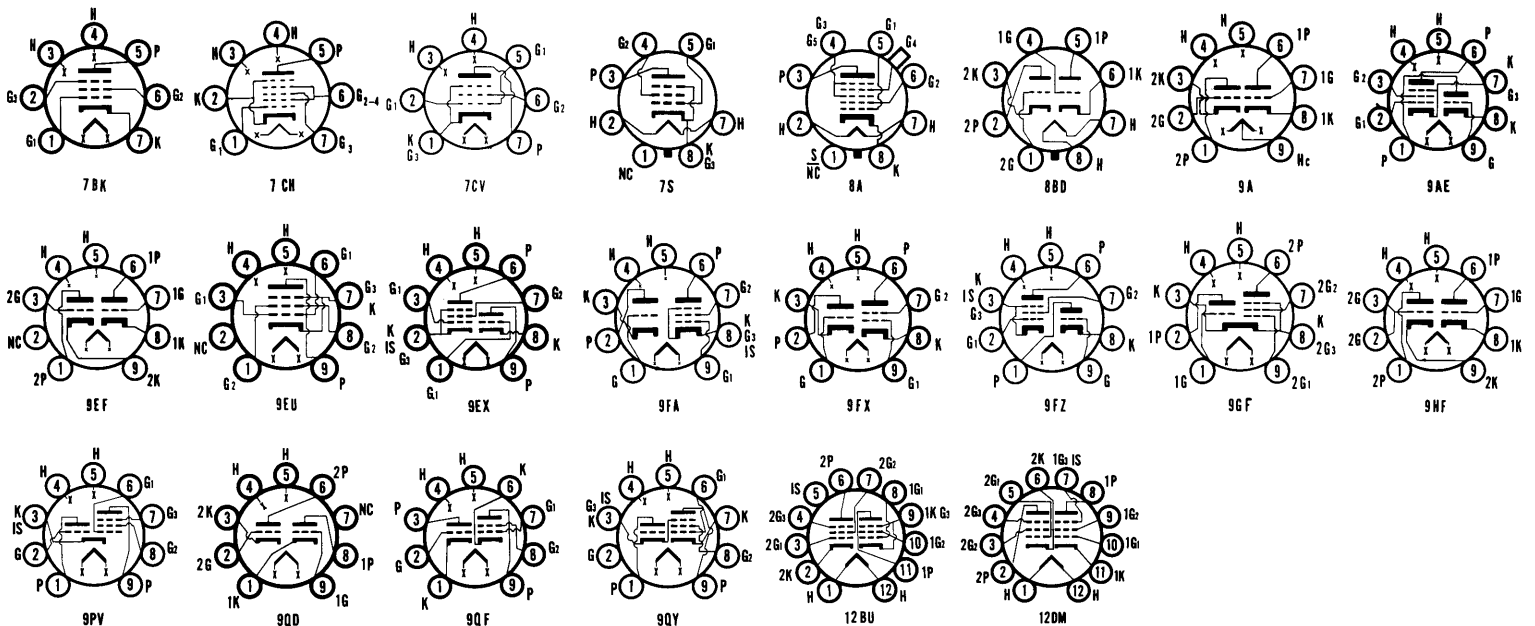

AVERAGE CHARACTERISTICS

TYPE	CONSTRUCTION			EMITTER		USE	Plate Diss. Watts ²	Plate Volts	Negative Grid Volts	Screen Volts	Plate Current Ma.	Screen Current Ma.	Plate Resis. Ohms	Trans-conductance Micros.	Amplification Factor	Ohms Load for Stated Power Output	Power Output Milli-watts
	Bulb Size or Style ¹	Class	Basing Diag.	Volts	Amps.												
10C8	T-6½	Tri. Pentode	9DA	10.5*	0.300	Tri. Amp. Pent. Amp.	2.0 2.2	250 135	390 [■] 100 [■] 135	7.3 11.5 3.2	12000 190000	4400 8000	53
10DA7	T-6½	Duotriode	9EF	10.5*	0.600	Vert. Osc. Vert. Defl. A.	2.2 6.6	Characteristics Same as Type 6DA7. (10DA7 Designed for Series String Receivers.)									
10DE7	T-6½	Duotriode	9HF	9.7*	0.600	Vert. Osc. Vert. Defl. A.	1.5 7.0	Characteristics Same as Type 6DE7. (10DE7 Designed for Series String Receivers.)									
10DR7	T-6½	Duotriode	9HF	9.7*	0.600	Vert. Amp. Vert. Osc.	7.0 1.0	Characteristics Same as Type 6DR7. (10DR7 Designed for Series String Receivers.)									
10DX8	T-6½	Triode Pent.	9HX	10.2*	0.450	Sync. Sep. Video Amp.	1.0 4.0	Characteristics Same as Type 6DX8. (10DX8 Designed for Series String Receivers.)									
10EB8	T-6½	Tri. Pentode	9DX	10.5*	0.450	A-F Amp. Video Amp.	1.0 5.0	Characteristics Same as Type 6EB8. (10EB8 Designed for Series String Receivers.)									
10EG7	T-9	Duotriode	8BD	9.7*	0.600	Vert. Amp. Vert. Defl. A. Vert. Osc.	10 1.5	Max. Peak Positive Pulse Plate Voltage = 1500 Volts. Max. D.C. Cathode Current = 50 Ma. 150 17.5 45 800 7500 6 250 11.0 5.5 8750 2000 17.5									
10EM7	T-6½	Duotriode	8BD	9.7*	0.600	Vert. Defl. Amp./Osc.	1.5 10	Characteristics Same as Type 6EM7. (10EM7 Designed for Series String Receivers.)									
10EW7	9-T9	Duotriode	9HF	9.7*	0.600	Vert. Defl. Osc./Amp.	1.5 10	Characteristics Same as Type 6EW7. (10EW7 Designed for Series String Receivers.)									
10FD7	9-T9	Duotriode	9HF	9.7*	0.600	Vert. Defl. Amp./Osc.	1.5 10	Characteristics Same as Type 6FD7. (10FD7 Designed for Series String Receivers.)									
10FR7	9-T9	Duotriode	9HF	9.7*	0.600	Vert. Defl. Amp./Osc.	1.5 10	Characteristics Same as Type 6FR7. (10FR7 Designed for Series String Receivers.)									
10GF7	Novar T-9	Double Tri.	9QD	9.7*	0.600	Ver. Defl. Osc. Ver. Defl. Amp.	1.5 11.0	Characteristics Same as Type 6GF7. (10GF7 Designed for Series String Receivers.)									
10HF8	T-6½	Tri. Pentode	9DX	10.5*	0.450	Gen. Purpose Video Amp.	1.0 5.0	Characteristics Same as Type 6HF8.									
10JA8	T-6½	Tri. Tetrode	9QF	10.5*	0.450	Sync. Sep. Video Amp.	1.0 5.0	Characteristics Same as Type 6JA8. (10JA8 Designed for Series String Receivers.)									
10JT8	T-9	Tri. Pentode	9DX	10.2*	0.450	Voltage Amp. Video Amp.	1.0 4.0	Characteristics Same as Type 6JT8. (10JT8 Designed for Series String Receivers.)									
10JY8	T-6½	Tri. Pentode	9DX	10.5*	0.450	Sync. Sep. Video Amp.	2.0 5.0	125 200	68 [■] 100 [■] 150	15 24 4.8	4400 55000	10400 11000	46
10KU8	T-9	Double Diode Pentode	9LT	10.2*	0.450	Phase Det. Video Amp. 4.0	Characteristics Same as Type 6KU8. (10KU8 Designed for Series String Receivers.)									
10LB8	T-9	Tri. Pentode	9DX	10.2*	0.450	Voltage Amp. Video Amp.	2.0 4.0	Characteristics Same as Type 6LB8. (10LB8 Designed for Series String Receivers.)									
11AR11	Comp. T-9	Duo. Pent.	12DM	11.2*	0.450	T.V. I-F Amp.	3.1	Characteristics Same as Type 6AR11. (11AR11 Designed for Series String Receivers.)									
11C5	T-5½	Beam Pent.	7CV	11.6*	0.450	Power Amp.	4.9	Characteristics Same as Type 35C5. (11C5 Designed for Series String Receivers.)									
11CY7	T-6½	Duotriode	9LG	11*	0.450	Vert. Osc. Vert. Defl. A.	1.0 5.5	Characteristics Same as Type 6CY7. (11CY7 Designed for Series String Receivers.)									
11JE8	T-6½	Tri. Pentode	9DX	10.9*	0.450	Gen. Purpose Video Amp.	1.0 4.0	Characteristics Same as Type 6JE8. (11JE8 Designed for Series String Receivers.)									
11KV8	T-6½	Triode Pent.	9DX	10.9*	0.450	Video Amp. Voltage Amp.	5.0 1.0	Characteristics Same as Type 6KV8. (11KV8 Designed for Series String Receivers.)									
12A6	Metal	Beam Pent.	7S	12.6	0.150	Power Amp.	8.25	250	12.5	250	30	3.5	70000	3000	7500	3400
12A8GT	T-9	Heptode	8A	12.6	0.150	Converter	1.1	Characteristics Same as Type 6A8G.									
12AB5	T-6½	Beam Pent.	9EU	12.6	0.200	S.T.A1 Amp. P.P.A1 Amp.	13.2	250 250	12.5 15	250 250	45 70	4.5 5	50000	4100 10000	5000	4500 10000
12AC6	T-5½	Pentode	7BK	12.6	0.150	R.F. Amp.	12.6	0	12.6	550μa	200μa	0.5 Meg.	730
12AD5	T-6½	Pentode	9AZ	12.6	0.100	R-F Amp.	2.2	100	2.5	100	6.0	1.75	600000	2200
12AD6	T-5½	Heptode	7CH	12.6	0.150	Hep. Mixer	12.6	2.2 Meg ⁴	12.6	350 μa.	1.5	320 [▲]

(1) See Frontal Section. (3) Has Special Mechanical and/or Life Characteristics. Controlled Heater Warm-up Time (applies to parallel connections of types having a tapped heater.)
 (2) Design Maximum Values. (4) Average Contact Potential Bias Developed Across Specified Grid Resistor.
 † Maximum Signal. ‡ Filamentary Type. ▲ Conversion Transconductance. ¶ Plate to Plate. ■ Cathode Resistor (ohms).

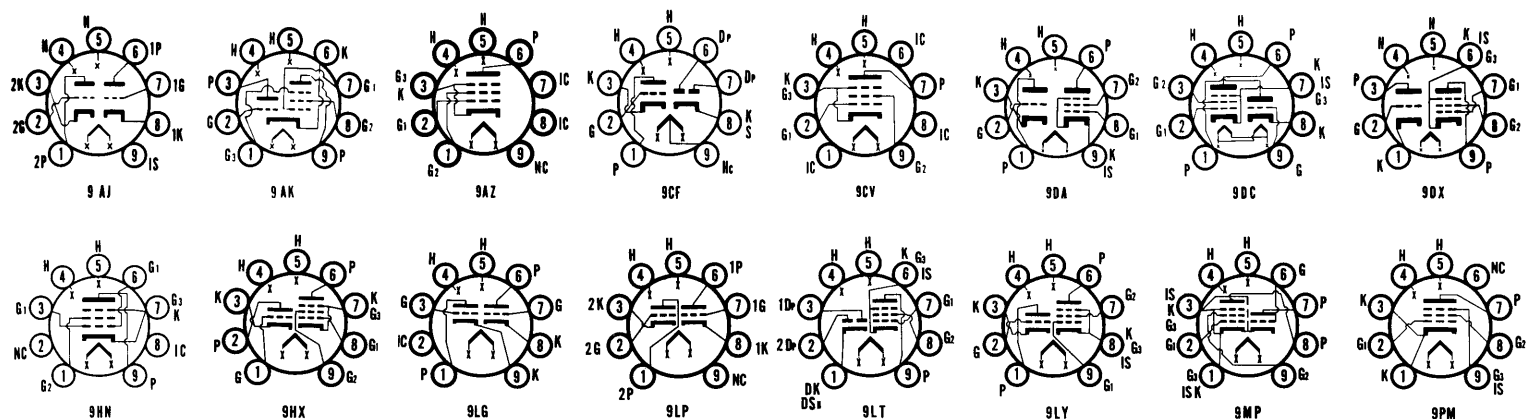

SYLVANIA TUBES

TYPE	CONSTRUCTION			EMITTER		USE	Plate Diss. Watts ²	Plate Volts	Negative Grid Volts	Screen Volts	Plate Current Ma.	Screen Current Ma.	Plate Resis. Ohms	Transconductance Micros.	Amplification Factor	Ohms Load for Stated Power Output	Power Output Milli-watts
	Bulb Size or Style ¹	Class	Basing Diag.	Volts	Amps.												
12AD7	T-6½	Duotriode	9A	12.6/6.3	0.225/0.450	A-F Amp.	1.1	250	2	1.25	62500	1600	100
12AE6	T-5½	Duodiode Tri.	7BT	12.6	0.150	Det. Amp.	12.6	0	0.75	15000	1000	15
12AE6A	T-5½	Duodiode Tri.	7BT	12.6	0.150	Det. Amp.	12.6	10 Meg ⁴	0.32	20000	715	14.3
12AE7	T-6½	Duotriode	9A	12.6	0.450	Dis. Triodes Voltage Amp. Pwr. Amp. Dr.	1.0 1.0	12.6	1.5 Meg ⁴ 1.0 Meg ⁴	1.9 7.5	3150 985	4000 6500	13 6.4
12AF3	T-6½	Diode	9CB	12.6*	0.600	T.V. Damper	6.0	Characteristics Same as Type 6AF3. (12AF3 Designed for Series String Receivers.)									
12AF6	T-5½	Pentode	7BK	12.6	0.150	R-F Amp.	12.6	0	12.6	1.1	0.45	0.35 Meg.	1500
12AG6	T-5½	Heptode	7CH	12.6	0.150	Converter	12.6	0.85	12.6	0.55	1.4	300 ^A	G1 = 20000 Ohms; G1 = 0.050 Ma.		
12AJ6	T-5½	Duodiode Tri.	7BT	12.6	0.150	Det. Amp.	12.6	0	0.75	45000	1200	55
12AL5	T-5½	Duodiode	6BT	12.6	0.150	Detector	Characteristics Same as Type 6AL5.									
12AL8	T-6½	Tri. Tetrode	9GS	12.6	0.550	Tri. Amp. Tet. Amp.	12.6	0.9 ⁴ 12.6 G2=0.5 ⁴	0.5 40	13000 480	1000 15000	13
12AL11	Comp. T-9	Duo. Pent.	12BU	12.6*	0.450	FM Det. S.T. A1 Amp.	1.7 10	Characteristics Same as Type 6AL11. (12AL11 Designed for Series String Receivers.)									
12AQ5	T-5½	Beam Pent.	7BZ	12.6	0.225	Power Amp.	13.2	Characteristics Same as Type 6AQ5.									
12AS5	T-5½	Beam Pent.	7CV	12.6	0.400	S.T. A1 Amp.	6.0	Characteristics Same as Type 6AS5.									
12AT6	T-5½	Duodiode Tri.	7BT	12.6	0.150	Det. Amp.	0.55	Characteristics Same as Type 6AT6.									
12AT7	T-6½	Duotriode	9A	6.3 12.6	0.300 0.150	VHF Amp.	2.75	100	270 ^M	3.7	4000	60
12AT7WA (3)								250	200 ^M	10.0	5500	60
12AU6	T-5½	Pentode	7BK	12.6	0.150	R-F Amp.	3.3	Characteristics Same as Type 6AU6.									
12AU7	T-6½	Duotriode	9A	12.6 6.3	0.150 0.300	Amplifier	3.0	250 100	8.5 0	10.5 11.8	7700 6500	2200 3100	17 20
12AV5GA	T-11 or T-12	Beam Pent.	6CK	12.6*	0.600	Horizontal Defl. Amp.	12.1	Characteristics Same as Type 6AV5GA. (12AV5GA Designed for Series String Receivers.)									
12AV6	T-5½	Duodiode Tri.	7BT	12.6	0.150	Det. Amp.	0.55	Characteristics Same as Type 6AV6.									
12AV7	T-6½	Duotriode	9A	12.6 6.3	0.225 0.450	A-F Amp.	2.97	100 150	120 ^M 56 ^M	9.0 18	6100 4800	6100 8500	37 41
12AW6	T-5½	Pentode	7CM	12.6	0.150	R-F Amp.	2.2	250 125 100	200 ^M 100 ^M	150 125 100	7.0 7.2 5.5	2.0 2.1 1.6	0.8 Meg. 0.5 Meg. 0.3 Meg.	5000 5100 4750
12AX3	Comp. T-9	Diode	12BL	12.6*	0.600	T.V. Damper	5.3	Characteristics Same as Type 6AX3. (12AX3 Designed for Series String Receivers.)									
12AX4GT 12AX4GTA	T-9	Diode	4CG	12.6 12.6*	0.600 0.600	T.V. Damper	5.28	P.I.V. = 4400 Volts Max., D.C. Plate Current = 125 Ma. Max. (12AX4GTA Designed for Series String Receivers.)									
12AX4GTB	T-9	Diode	4CG	12.6*	0.600	T.V. Damper	5.28	P.I.V. = 5000 Volts Max., D.C. Plate Current = 125 Ma. Max.									
12AX7	T-6½	Duotriode	9A	12.6 6.3	0.150 0.300	Amplifier	1.1	100 250	1 2	0.5 1.2	80000 62500	1250 1600	100 100
12AX7A	T-6½	Duotriode	9A	12.6 6.3	0.150 0.300	Audio Amp.	1.1	Low Noise and Low Microphoism Version of Identical Type 12AX7.									
12AY3	Novar T-9	Diode	9HP	12.6*	0.600	T.V. Damper	6.5	Characteristics and Ratings Same as Type 6AY3. (12AY3 Designed for Series String Receivers.)									
12AY7	T-6½	Duotriode	9A	12.6	0.150	Audio Amp.	1.65	250	4.0	3.0	1750	40
12AZ7	T-6½	Duotriode	9A	6.3* 12.6	0.450 0.225	VHF Amp.	2.75	100 250	270 ^M 200 ^M	3.7 10.0	15000 10900	4000 5500	60 60
12AZ7A	T-6½	Duotriode	9A	12.6/ 6.3*	0.225 0.450	VHF Osc./ Amp.	2.5	Characteristics Same as Type 12AZ7.									
12B3	T-6½	Diode	9BD	12.6*	0.600	T.V. Damper	Characteristics Same as Type 6B3. (12B3 Designed for Series String Receivers.)									
12B4A	T-6½	Triode	9AG	6.3* 12.6	0.600/ 0.300	Vert. Defl. Amplifier	6.0	Max. Peak Pos. Pulse Plate Voltage = 1000 Volts Max. D.C. Cathode Current = 30 Ma. (12B4A Designed for Series String Receivers.)									
							150	17.5	35	6500	6.5	

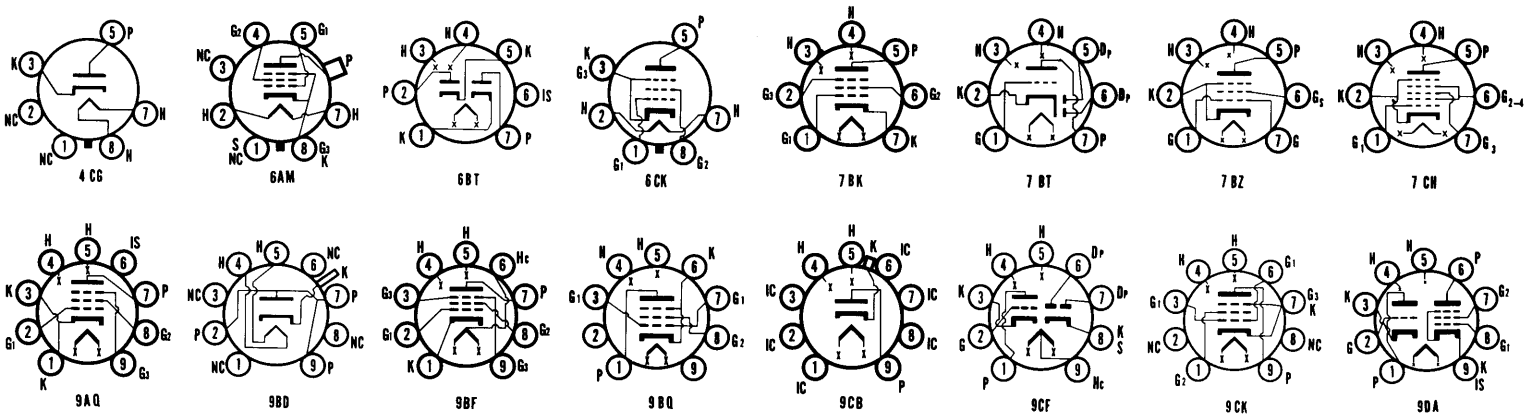

AVERAGE CHARACTERISTICS

TYPE	CONSTRUCTION			EMITTER		USE	Plate Diss. Watts ²	Plate Volts	Negative Grid Volts	Screen Volts	Plate Current Ma.	Screen Current Ma.	Plate Resis. Ohms	Transcon-ductance Micros.	Amplifi-cation Factor	Ohms Load for Stated Power Output	Power Output Milli-watts
	Bulb Size or Style ¹	Class	Basing Diag.	Volts	Amps.												
12BA6	T-5½	Pentode	7BK	12.6	0.150	R-F Amp.	3.3	Characteristics Same as Type 6BA6.									
12BA7	T-6½	Heptode	8CT	12.6	0.150	Converter	2.2	Characteristics Same as Type 6BA7.									
12BD6	T-5½	Pentode	7BK	12.6	0.150	R-F Amp.	3.3	Characteristics Same as Type 6BD6.									
12BE3	Comp. T-9	Diode	12BL	12.6*	0.600	T.V. Damper	6.5	Characteristics Same as Type 6BE3. (12BE3 Designed for Series String Receivers.)									
12BE6	T-5½	Heptode	7CH	12.6	0.150	Converter	1.1	Characteristics Same as Type 6BE6.									
12BF6	T-5½	Duodiode Tri.	7BT	12.6	0.150	Det. Amp.	2.75	250	9.0	9.5	8500	1900	16	10000	300		
12BH7	T-6½	Duotriode	9A	6.3*/12.6	0.600/0.300	Vert. Defl. Amplifier	3.85	Max. Peak Pos. Pulse Plate Voltage = 1500 Volts Max. D.C. Cathode Current = 20 Ma. (12BH7A Designed for Series String Receivers.)									
12BJ3	Comp. T-9	Diode	12BL	12.6*	0.450	T.V. Damper	5.3	Max. Peak Inverse Plate Voltage = 3300 Volts. Max. Cathode Current = 165 Ma.									
12BK5	T-6½	Beam Amp.	9BQ	12.6*	0.600	Power Amp.	9.9	Characteristics Same as Type 6BK5. (12BK5 Designed for Series String Receivers.)									
12BL6	T-5½	Pentode	7BK	12.6	0.150	R-F Amp.	12.6	0.65*	12.6	1.35	0.5	500000	1350	
12BN6	T-5½	Gated Beam	7DF	12.6	0.150	Quad. F.M. Detector	Characteristics Same as Type 6BN6.									
12BQ6GTA	T-11 T-9	Beam Pent.	6AM	12.6*	0.600	Horiz. Defl. Amplifier	12.1	Characteristics Same as Type 6BQ6GTA. (12BQ6GTA Designed for Series String Receivers.)									
12BQ6GTB	T-9	Beam Pent.	6AM	12.6*	0.600	Horiz. Amp.	12.1	Characteristics Same as Type 6BQ6GTB. (12BQ6GTB Designed for Series String Receivers.)									
12BR3	T-6½	Diode	9CB	12.6*	0.600	T.V. Damper	6.5	Characteristics Same as Type 6BR3. (12BR3 Designed for Series String Receivers.)									
12BR7	T-6½	Duodiode Tri.	9CF	12.6/6.3	0.225/0.450	Det. Amp.	2.75	100	270	3.7	15000	4000	60	
12BS3	Novar T-9	Diode	9HP	12.6*	0.600	T.V. Damper	6.0	Characteristics Same as Type 6BS3. (12BS3 Designed for Series String Receivers.)									
12BV7	T-6½	Pentode	9BF	12.6/6.3	0.300/0.600	Video Amp.	6.87	250	68	150	27	6.0	85000	13000	1000	
12BW4	T-6½	Duodiode	9DJ	12.6	0.450	F-W Rect.	Characteristics Same as Type 6BW4									
12BX6	T-6½	Pentode	9AQ	12.6	0.150	VHF Amp.	2.5	Characteristics Same as Type 6BX6. (12BX6 Designed for Series String Receivers.)									
12BY7	T-6½	Pentode	9BF	6.3	0.600	Video Amp.	7.1	250	100	180	26	5.75	93000	11000	1035	
12BZ6	T-5½	Pentode	7CM	12.6	0.150	R-F Amp.	2.3	Characteristics Same as Type 6BZ6.									
12BZ7	T-6½	Duotriode	9A	6.3/12.6	0.600/0.300	Sync. Sep. or Amplifier	1.65	250	2	2.5	31800	3200	100	Cout Sec. 1 = 0.7	
12C5	T-5½	Beam Pent.	7CV	12.6*	0.600	Power Amp.	6.6	120	8	110	49	4.0	10000	7500	2500	2300
12C8	Metal	Duodi. Pent.	8E	12.6	0.150	Det. Amp.	2.47	Characteristics Same as Type 6B8.									
12CA5	T-5½	Beam Pent.	7CV	12.6*	0.600	Power Amp.	5.5	Characteristics Same as Type 6CA5. (12CA5 Designed for Series String Receivers.)									
12CM6	T-6½	Beam Pent.	9CK	12.6	0.225	Power Amp.	13.2	Characteristics Same as Type 6CM6.									
12CN5	T-5½	Pentode	7CV	12.6	0.450	I-F Amp.	12.6	2.2 Meg ⁴	12.6	4.5	0.35	40000	3800	
12CR6	T-5½	Diode Pent.	7EA	12.6	0.150	Audio Amp.	2.75	250	2	100	9.6	2.6	800000	2200	
12CS6	T-5½	Dual Control Heptode	7CH	12.6	0.150	Sync. Sep.	11	100	0.0 Gr. 1	30	0.8	4.0	700000	950 Gr. 1	Grid 3 Volts = 0	
12CT8	T-6½	Tri. Pentode	9DA	12.6*	0.300	Sync. Amp. Video Amp.	2.5	150	150	9.0	8200	4900	40	
12CU5	T-5½	Beam Pent.	7CV	12.6*	0.600	Power Amp.	6.6	Characteristics Same as Type 6CU5. (12CU5 Designed for Series String Receivers.)									
12CU6	T-12	Beam Pent.	6AM	12.6*	0.600	Horiz. Defl. Amplifier	12.1	Characteristics Same as Type 6BQ6G, except Max. D.C. Plate Supply = 550 Volts. (12CU6 Designed for Series String Receivers.)									
12CX6	T-5½	Pentode	7BK	12.6	0.150	R-F Amp.	12.6	2.2 Meg ⁴	12.6	3.0	1.4	40000	3100	
12CY6	T-5½	Pentode	7BK	12.6	0.200	R-F Amp.	12.6	2.2 Meg ⁴	12.6	1.6	0.4	140000	3250	
12D4	T-9	Diode	4CG	12.6*	0.600	T.V. Damper	5.5	Max. Inverse Peak Plate Voltage = 4400 Volts. Max. D.C. Plate Current = 155 Ma.									
12D4A	T-9	Diode	4CG	12.6*	0.600	T.V. Damper	8.0	Max. Peak Inverse Plate Voltage = 5000 Volts. Max. D.C. Plate Current = 185 Ma. Characteristics Same as Type 6DA4A.									

- (1) See Frontal Section. (2) Design Maximum Values. † Maximum Signal. (3) Has Special Mechanical and/or Life Characteristics. (4) Average Contact Potential Bias Developed Across Specified Grid Resistor. ♦ Filamentary Type. * Controlled Heater Warm-up Time (applies to parallel connections of types having a tapped heater.) † Plate to Plate. ■ Cathode Resistor (ohms).

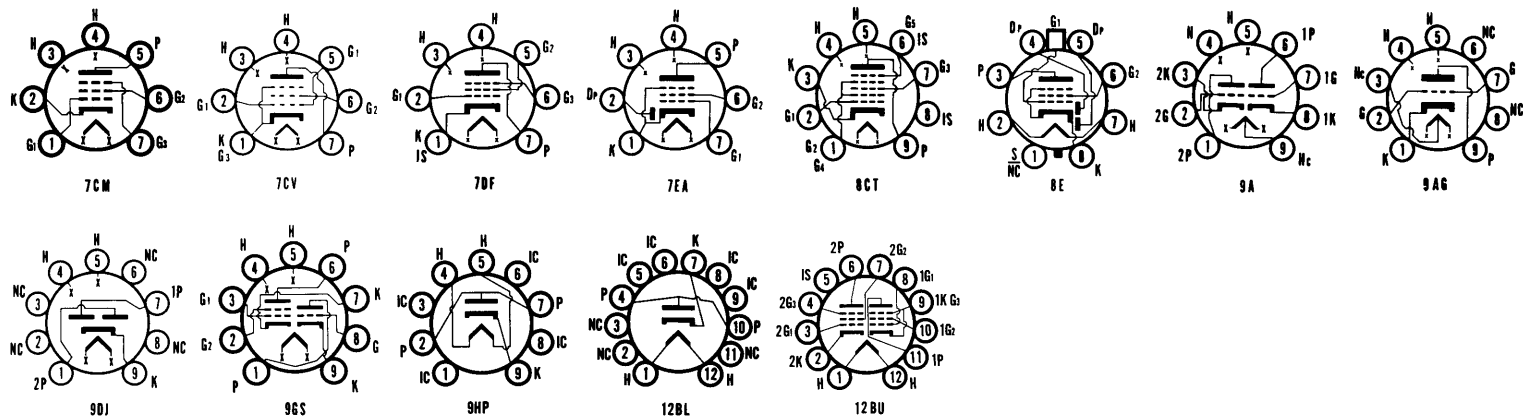

SYLVANIA TUBES

TYPE	CONSTRUCTION			EMITTER		USE	Plate Diss. Watts ²	Plate Volts	Negative Grid Volts	Screen Volts	Plate Current Ma.	Screen Current Ma.	Plate Resis. Ohms	Transconductance Micros.	Amplification Factor	Ohms Load for Stated Power Output	Power Output Milli-watts
	Bulb Size or Style ¹	Class	Basing Diag.	Volts	Amps.												
12DB5	T-6½	Beam Pent.	9GR	12.6*	0.600	Vert. Defl. Amplifier	11	Characteristics Same as Type 6DB5. (12DB5 Designed for Series String Receivers.)									
12DE8	T-6½	Diode Pent.	12DE8	12.6	0.200	R-F or I-F Amplifier	12.6	0.8 ⁴	12.6	1.3	0.5	30000	1500
12DF5	T-6½	Duodiode	9BS	12.6 6.3	0.450 0.900	F-W Rect.	325 A.V. Volts Per Plate, RMS, 100 Ma. Output Current. Condenser Input. 450 A.C. Volts Per Plate, RMS, 100 Ma. Output Current. Choke Input.									
12DF7	T-6½	Duotriode	9A	12.6 6.3	0.150 0.300	Audio Amp.	1.1	Characteristics Same as Type 12AX7. (Special Low Noise.)									
12DJ8	T-6½	Duotriode	9AJ	12.6	0.180	VHF Amp.	2.0	Characteristics Same as Type 6DJ8.									
12DK5	T-6½	Pentode	9GT	12.6	0.300	R-F Amp.	12.6	2.2 Meg ⁴	12.6	2.0	0.65	100000	3300
12DK6	T-5½	Pentode	7CM	12.6*	0.150	VHF Amp.	2.2	Characteristics Same as Type 6DK6. (12DK6 Designed for Series String Receivers.)									
12DK7	T-6½	Duodiode Tetrode	9HZ	12.6	0.500	Det. Power Amp. Driver	0.55	12.6	2.2 Meg ⁴	12.6	6.0	1.0	4000	5000	3500	10
12DL8	T-6½	Duodiode Tetrode	9HR	12.6	0.550	Det. Power Amp. Driver	12.6 G ₂ = 2 G ₁ = 12.6 (Space-Charge Grid Operation.)									
12DM4	T-9	Diode	4CG	12.6*	0.600	T.V. Damper	6.5	Characteristics Same as Type 6DM4. (12DM4 Designed for Series String Receivers.)									
12DM4A	T-9	Diode	4CG	12.6*	0.600	T.V. Damper	6.5	Characteristics Same as Type 6DM4A. (12DM4A Designed for Series String Receivers.)									
12DM5	T-5½	Beam Pent.	7CV	12.6*	0.450	Power Amp.	6.0	110	7.5	110	49.0	4.0	14000	7500	2500	1900
12DM7	T-6½	Duotriode	9A	6.3 12.6	0.260 0.130	A-F Amp.	1.1	Low Noise and Low Microphonism Version of Type 12AX7.									
12DQ4	T-9	Diode	4CG	12.6*	0.600	T.V. Damper	6.0	Characteristics Same as Type 6DQ4. (12DQ4 Designed for Series String Receivers.)									
12DQ6A	T-12	Beam Pent.	6AM	12.6*	0.600	Horiz. Defl. Amplifier	16.5	Characteristics Same as Type 6DQ6A. (12DQ6A Designed for Series String Receivers.)									
12DQ6B	T-12	Beam Pent.	6AM	12.6*	0.600	Horiz. Defl. Amplifier	18	Characteristics Same as Type 6DQ6B. (12DQ6B Designed for Series String Receivers.)									
12DQ7	T-6½	Pentode	9BF	12.6/ 6.3*	0.300 0.600	Video Amp.	6.5	200	68 [■]	125	26	5.6	53000	10500
12DS7 12DS7A	T-6½	Duodiode Tetrode	9JU	12.6	0.400	Det. Power Driver	12.6	2.2 Meg ⁴	G ₁ = 12.6	35-15†	80	700	35
12DT5	T-6½	Beam Pent.	9HN	12.6*	0.600	Vert. Defl. Amplifier	9.0	Characteristics and Ratings Same as Type 6DT5. (12DT5 Designed for Series String Receivers.)									
12DT6	T-5½	Gated Beam	7EN	12.6	0.150	Quad FM Det.	1.7	Characteristics Same as Type 6DT6.									
12DT7	T-6½	Duotriode	9A	6.3 12.6	0.300 0.150	A-F Amp.	1.1	Characteristics Same as Type 12AX7. Controlled for Hum and Noise.									
12DT8	T-6½	Duotriode	9AJ	12.6	0.150	A-F Amp.	2.75	100 250	270 [■] 200 [■]	3.7 10	15000 10900	4000 5500	60 60
12DU7	T-6½	Duodiode Tetrode	9JX	12.6	0.250	Det. Power Amp. Driver	12.6	2.2 Meg ⁴	12.6	12	1.5	6000	6200	2700	25
12DV7	T-6½	Duodiode Tri.	9JY	12.6	0.150	Det. Amp.	12.6	2.2 Meg ⁴	0.4	19000	750	14
12DV8	T-6½	Duodiode Tetrode	9HR	12.6	0.375	Detector, Pwr. Amp. Dr.	12.6	18 Ohm [■]	G ₁ = 12.6	6.8	54	900	8500	7.6	1250	5
12DW5	T-6½	Beam Pent.	9CK	12.6*	0.600	Vert. Defl. Amplifier	11	Max. Peak Positive Plate Voltage = 2200 Volts. Max. D.C. Cathode Current = 65 Ma. 200 22.5 150 55 2.0 15000 5500									
12DW7	T-6½	Duotriode	9A	6.3 12.6	0.300 0.150	Sect. 1 A-F Voltage Amp. Sect. 2 A-F Phase Inverter	1.2 3.3	100 250	1.0 2.0	0.5 1.2	80000 62500	1250 1600	100 100
12DW8	T-6½	Diode-Duo-Triode	9JC	12.6	0.450	Dissimilar Tri's Voltage Amp. Pwr. Amp. Dr.	0.5 0.5	12.6 12.6	1.5 Meg ⁴ 1.0 Meg ⁴	1.9 7.5	3520 970	2700 6500	9.5 6.4
12DZ6	T-5½	Pentode	7BK	12.6	0.190	R-F Amp.	12.6	G ₁ = 10 Meg ⁴	12.6	4.5	2.2	25000	3800

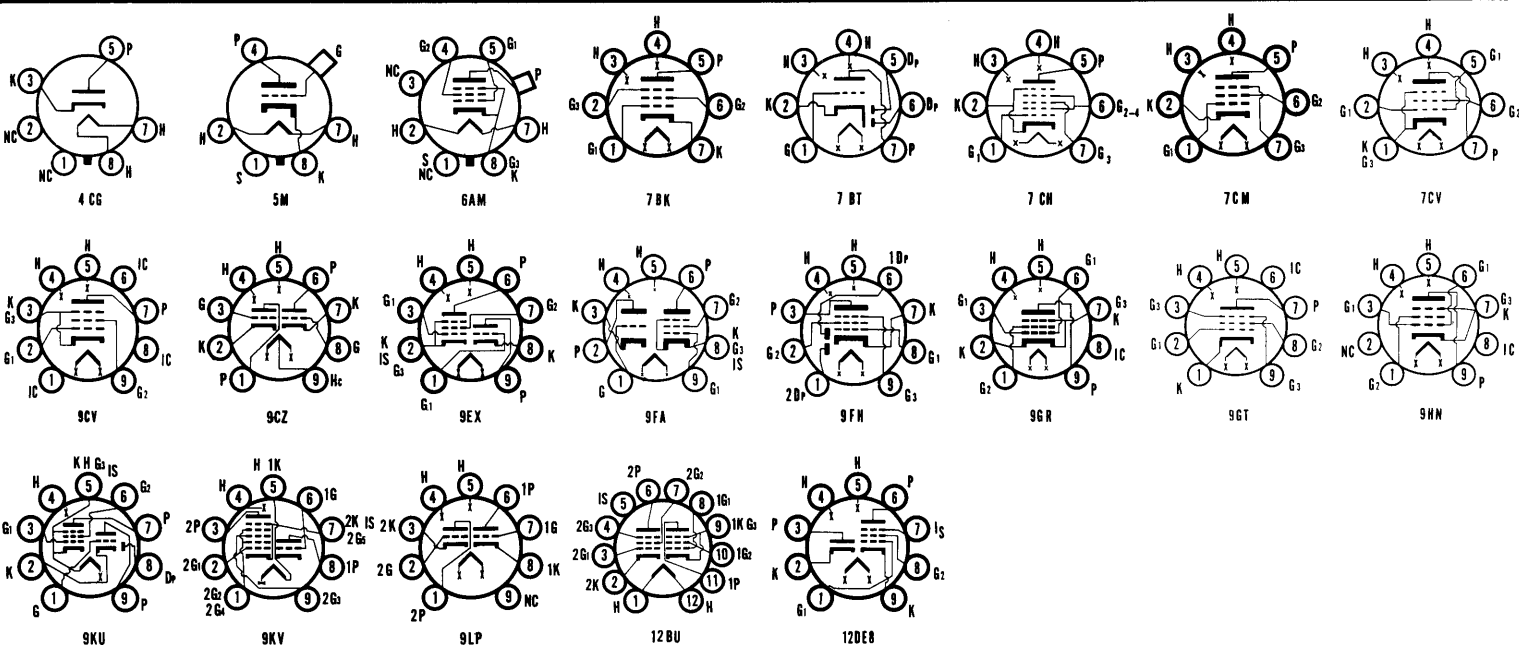

AVERAGE CHARACTERISTICS

TYPE	CONSTRUCTION			EMITTER		USE	Plate Diss. Watts ²	Plate Volts	Negative Grid Volts	Screen Volts	Plate Current Ma.	Screen Current Ma.	Plate Resis. Ohms	Trans-conductance Micros.	Amplification Factor	Ohms Load for Stated Power Output	Power Output Milli-watts
	Bulb Size or Style ¹	Class	Basing Diag.	Volts	Amps.												
12DZ8	T-6½	Tri. Beam Pentode	9EX	12	0.450	A-F Voltage Amp. and Power Amp.	.825	Characteristics Same as Type 6DZ8. (12DZ8 Designed for Series String Receivers.)									
12EA6	T-5½	Pentode	7BK	12.6	0.190	I-F Amp.	7.15	12.6	G1 = 10 Meg G3 = 0	12.6	3.2	1.4	32000	3800
12EC8	T-6½	Tri. Pentode	9FA	12.6	0.225	FM Osc. FM Amp.	12.6	0	12.6	0.66	0.28	6000	4700	25
12ED5	T-5½	Pentode	7CV	12.6	0.450	S.T. A1 Amp.	6.25	110	4.0	110	32	4	14000	8100	4500	1100
12EF6	T-9	Beam Pent.	7S	12.6*	0.450	Vert. Defl. Amplifier	11	Characteristics Same as Type 6EF6. (12EF6 Designed for Series String Receivers.)									
12EG6	T-5½	Heptode	7CH	12.6	0.150	Mixer Oscillator	12.6	0.8 ⁴	12.6	.04	2.47	150000	800
12EH5	T-5½	Beam Pent.	7CV	12.6*	0.600	S.T. A1 Amp.	5.5	Characteristics Same as Type 6EH5. (12EH5 Designed for Series String Receivers.)									
12EK6	T-5½	Pentode	7BK	12.6	0.190	FM Amp.	12.6	2.2 ⁴	12.6	4.0	1.7	50000	4200
12EL6	T-5½	Duodiode Tri.	7FB	12.6	0.150	Det. Amp.	12.6	1.0 Meg ⁴75	45000	1200	55
12EM6	T-6½	Diode Tetrode	9HV	12.6	0.500	Det. Power Amplifier	0.55	12.6	15 Meg ⁴	12.6	6.0	1.0	4000	5000	3500	10
12EN6	T-9	Beam Pent.	7S	12.6*	0.600	Vert. Defl. Amplifier	7.0	Max. Peak Positive Pulse Plate Voltage = 1200 Volts. Max. D.C. Cathode Currents = 50 Ma.									
12EQ7	T-6½	Diode Pent.	9LP	12.6	0.150	Det. R-F Amp.	3.0	Characteristics Same as Type 6EQ7.									
12EZ6	T-5½	Pentode	7BK	12.6	0.175	R-F or I-F Amplifier	12.6	0.7	12.6	1.9	0.7	400000	2700
12F5GT	T-9	Triode	5M	12.6	0.150	Amplifier	Characteristics Same as Type 6F5GT.									
12F8	T-6½	Duodi. Pent.	9FH	12.6	0.150	Amplifier	12.6	0	12.6	1.0	0.38	0.33 Meg.	1000
12FA6	T-5½	Heptode	7CH	12.6	0.150	Converter	12.6	0.5	12.6	.45	1.0	800000	320 ⁴
12FB5	T-6½	Beam Pent.	9CV	12.6	0.300	S.T. A1 Amp.	6.6	170	10.3	180	31	7.3	5000	2250
12FK6	T-5½	Duodiode Tri.	7BT	12.6	0.150	Det. Amp.	12.6	2.2 Meg ⁴	1.3	6200	1200	74
12FM6	T-5½	Duodiode Tri.	7BT	12.6	0.150	Det. Amp.	12.6	2.2 Meg ⁴	1.0	7700	1300	10
12FQ8	T-6½	Twin, Double-Plate Triode	9KT	12.6	0.150	Det. Amp.	0.5	250	1.5	1.5	76000	1250	95
12FR8	T-6½	Tri. Pentode Diode	9KU	12.6	0.320	Det. R-F Amp.	12.6	2.2 Meg ⁴	1.0	1200	10
12FT6	T-5½	Duodiode Triode	7BT	12.6	0.150	Det. Power Amp. Driver	12.6	2.2 Meg ⁴	0.6	13000	1000	14
12FV7	T-6½	Duotriode	9A	6.3/ 12.6	0.900/ 0.450	Relay Control Tube	2.5	100	2.0	16	2250	9600
12FX5	T-5½	Pentode	7CV	12.6*	0.450	Power Amp.	5.5	110	62 ⁴	115	35	12	17500	13500	3000	1300
12FX8	T-6½	Tri. Heptode	9KV	12.6	0.270	Tri. R-F Amp. Heptode Conv.	12.6	2.2 Meg ⁴	12.6	1.3	500000	1400	10
12FX8A	T-6½	Tri. Heptode	9KV	12.6	0.270	R-F Amp. Converter	12.6	2.2 Meg ⁴	12.6	1.3	1400	10
12G8	T-6½	Duotriode	9CZ	12.6	0.400	Amplifier	12.6	0	Input Tri. 12.6	3.0	8500	2600	22	2000	25
12G11	Comp. T-9	Double Pent.	12BU	12.6*	0.600	FM Det. Power Output	1.7 6.5	Characteristics Same as Type 6G11. (12G11 Designed for Series String Receivers.)									

(1) See Frontal Section. (2) Design Maximum Values. † Maximum Signal. (3) Has Special Mechanical and/or Life Characteristics. (4) Average Contact Potential Bias Developed Across Specified Grid Resistor. ‡ Filamentary Type. * Controlled Heater Warm-up Time (applies to parallel connections of types having a tapped heater.) † Plate to Plate. † Conversion Transconductance. † Cathode Resistor (ohms).

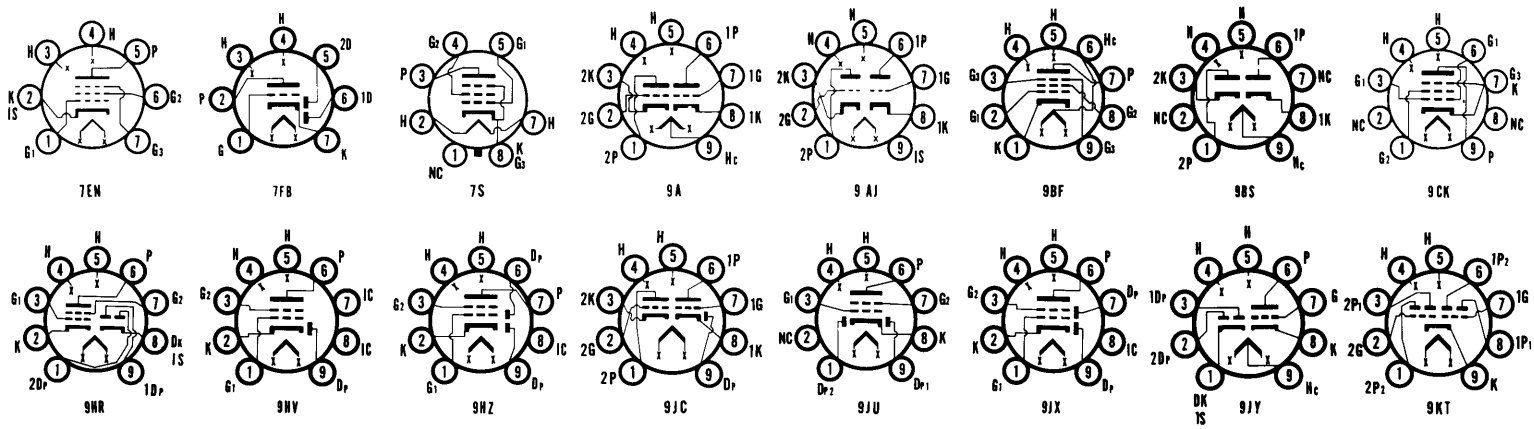

SYLVANIA TUBES

TYPE	CONSTRUCTION			EMITTER		USE	Plate Diss. Watts ²	Plate Volts	Negative Grid Volts	Screen Volts	Plate Current Ma.	Screen Current Ma.	Plate Resis. Ohms	Transconductance Micros.	Amplification Factor	Ohms Load for Stated Power Output	Power Output Milli-watts
	Bulb Size or Style ¹	Class	Basing Diag.	Volts	Amps.												
12GA6	T-5½	Heptode	7CH	12.6	0.150	Converter	12.6	G ² =2.2 M ⁴	12.6	0.3	0.8	1.0 Meg.	140
12GC6	T-12	Beam Pent.	8JX	12.6*	0.600	Horiz. Defl. Amplifier	17.5	Characteristics Same as Type 6GC6. (12GC6 Designed for Series String Receivers.)									
12GE5	Comp. T-12	Beam Pent.	12BJ	12.6*	0.600	Horiz. Defl. Amplifier	17.5	Characteristics Same as Type 6GE5. (12GE5 Designed for Series String Receivers.)									
12GN6	T-5½	Pentode	7FW	12.6	0.150	R-F Amp.	3.3	Characteristics Same as Type 6GN6.									
12GN7	T-6½	Pentode	9BF	6.3 12.6*	0.600 0.300	Video Amp.	7.5	250	56 ^m	150	28	6.5	50000	36000
12GJ5	Novar T-12	Beam Pent.	9QK	12.6*	0.600	Horiz. Defl. Amplifier	17.5	Characteristics Same as Type 6GJ5. (12GJ5 Designed for Series String Receivers.)									
12GT5	Novar T-12	Beam Pent.	9NZ	12.6*	0.600	Horiz. Defl. Amplifier	17.5	Characteristics Same as Type 6GT5. (12GT5 Designed for Series String Receivers.)									
12GW6	T-12	Beam Pent.	6AM	12.6*	0.600	Horiz. Defl. Amplifier	17.5	Characteristics Same as Type 6GW6. (12GW6 Designed for Series String Operation.)									
12H6	Metal	Duodiode	7Q	12.6	0.150	Rectifier	Characteristics Same as Type 6H6.									
12J5GT	T-9	Triode	6Q	12.6	0.150	Amplifier	2.75	Characteristics Same as Type 6J5GT.									
12J7GT	T-9	Pentode	7R	12.6	0.150	R-F Amp.	.825	Characteristics Same as Type 6J7G.									
12J8	T-6½	Duo. Tetrode	9GC	12.6	0.300	Det. Amp.	12.6	2.2 Meg ⁴	12.6	12	1.5	6000	5500	2700	20
12JB6	Novar T-12	Pentode	9QL	12.6*	0.600	Horiz. Defl. Amp.	17.5	Characteristics Same as Type 6JB6. (12JB6 Designed for Series String Receivers.)									
12JN8	T-6½	Tri. Pentode	9FA	12.6	0.225	Oscillator Voltage Amp.	2.5 2.5	Characteristics Same as Type 6JN8.									
12K5	T-5½	Tetrode	7FD	12.6	0.400	Power Amp. Driver	12.6	G ² =2	G ¹ =12.6	8	75	480	15000	7.2	800	40
12K7GT	T-9	Pentode	7R	12.6	0.150	R-F Amp.	3.0	Characteristics Same as Type 6K7G.									
12K8	Metal	Tri. Hexode	8K	12.6	0.150	Mixer Osc. Converter	3.0	Characteristics Same as Type 6K8GT.									
12KL8	T-6½	Diode Pent.	9LQ	12.6*	0.150	Detector R-F I-F Amp. 3.0	Characteristics Same as Type 6KL8. (12KL8 Designed for Series String Receivers.)									
12L6GT	T-9	Beam Pent.	7S	12.6*	0.600	Power Amp.	11	Characteristics Same as Type 25L6GT. (12L6GT Designed for Series String Receivers.)									
12Q7GT	T-9	Duodiode Tri.	7V	12.6	0.150	Det. Amp.	0.55	Characteristics Same as Type 6Q7GT.									
12R5	T-5½	Beam Pent.	7CV	12.6*	0.600	Vert. Defl. Amplifier	4.95	Max. Peak Positive Pulse Plate Voltage = 1500 Volts. Max. D.C. Cathode Current = 45 Ma. 110 8.5 110 40.0 3.3 13000 7000									
12SA7	Metal T-9	Heptode	8R	12.6	0.150	Converter	1.1	Characteristics Same as Type 6SA7.									
12SC7	Metal	Duotriode	8S	12.6	0.150	A-F Amp.	3.85	Characteristics Same as Type 6SC7.									
12SF5	Metal T-9	Triode	6AB	12.6	0.150	A-F Amp.	Characteristics Same as Type 6SF5.									
12SF7	Metal	Diode Pent.	7AZ	12.6	0.150	Det. Amp.	3.85	Characteristics Same as Type 6SF7.									
12SG7	Metal	Pentode	8BK	12.6	0.150	R-F Amp.	3.3	Characteristics Same as Type 6SG7.									
12SH7	Metal	Pentode	8BK	12.6	0.150	R-F Amp.	3.3	Characteristics Same as Type 6SH7.									
12SJ7	Metal T-9	Pentode	8N	12.6	0.150	A-F Amp.	2.75	Characteristics Same as Type 6SJ7.									
12SK7	Metal T-9	Pentode	8N	12.6	0.150	R-F Amp.	4.4	Characteristics Same as Type 6SK7.									
12SL7GT	T-9	Duotriode	8BD	12.6	0.150	Amplifier	1.1	Characteristics Same as Type 6SL7GT.									
12SN7GTA	T-9	Duotriode	8BD	12.6	0.300	Vertical Osc. Amp.	3.85	Characteristics Same as Type 6SN7GTA.									
12SQ7	Metal T-9	Duodiode Tri.	8Q	12.6	0.150	Det. Amp.	0.55	Characteristics Same as Type 6SQ7.									
12SR7	Metal	Duodiode Tri.	8Q	12.6	0.150	Det. Amp.	2.75	Characteristics Same as Type 6SR7.									
12U7	T-6½	Duotriode	9A	12.6	0.150	Class A1 Amp.	12.6	0	1.0	12500	1600	20

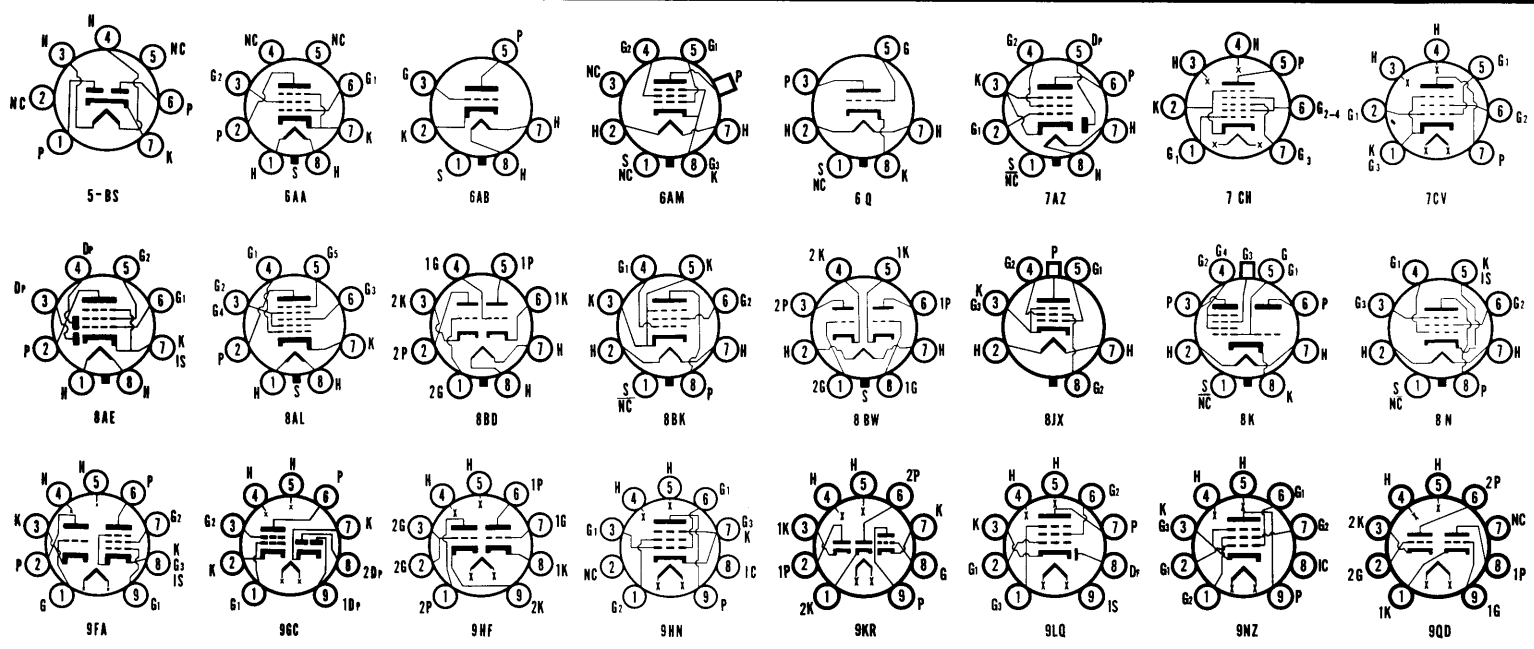

AVERAGE CHARACTERISTICS

TYPE	CONSTRUCTION			EMITTER		USE	Plate Diss. Watts ²	Plate Volts	Negative Grid Volts	Screen Volts	Plate Current Ma.	Screen Current Ma.	Plate Resis. Ohms	Transcon-ductance Micros.	Amplifi-cation Factor	Ohms Load for Stated Power Output	Power Output Milli-watts
	Bulb Size or Style ¹	Class	Basing Diag.	Volts	Amps.												
12V6GT	T-9	Beam Pent.	7S	12.6	0.225	Power Amp.	13.2	180 250	8.5 12.5	180 250	29 45	3 4.5	50000 50000	3700 4100	5500 5000	2000 4500
12W6GT	T-9	Beam Pent.	7S	12.6*	0.600	Power Amp. Vert. Defl. Amplifier	11	Characteristics Same as Type 6W6GT. (12W6GT Designed for Series String Receivers.)									
12X4	T-5½	Duodiode	5BS	12.6	0.300	F-W Rect.	Characteristics Same as Type 6X4.									
13CW4	M-N	Triode	12AQ	13.5	0.060	VHF Amp.	1.0	Characteristics Same as Type 6CW4.									
13DE7	T-6½	Duotriode	9HF	13.0*	0.450	Vert. Osc. Vert. Defl. Amplifier	1.5 7.0	Characteristics Same as Type 16DE7. (13DE7 Designed for Series String Receivers.)									
13DR7	T-6½	Duotriode	9HF	13*	0.450	S. 2 Ver. Amp. S. 1 Ver. Osc.	1.0 7.0	Characteristics Same as Type 6DR7. (13DR7 Designed for Series String Receivers.)									
13EM7	T-9	Duotriode	8BD	13*	0.450	Vert. Defl. Amp./Osc.	1.5 10	Characteristics Same as Type 6EM7. (13EM7 Designed for Series String Receivers.)									
13FD7	9-T9	Duotriode	9HF	13.0*	0.450	Vert. Defl. Amp./Osc.	1.5 10	Characteristics Same as Type 6FD7. (13FD7 Designed for Series String Receivers.)									
13FM7	Comp. T-9	Double Tri.	12EJ	13.0*	0.450	Ver. Defl. Osc. Ver. Defl. Amp.	1.0 10.0	Characteristics Same as Type 6FM7. (13FM7 Designed for Series String Receivers.)									
13FR7	9-T9	Duotriode	9HF	13.0*	0.450	Vert. Defl. Amp./Osc.	1.5 10	Characteristics Same as Type 6FR7. (13FR7 Designed for Series String Receivers.)									
13GB5	Magnoval T-9	Beam Pent.	9HN	13.3*	0.600	Horiz. Defl. Amp.	17	Characteristics Same as Type 6GB5. (13GB5 Designed for Series String Receivers.)									
13GF7	Novar T-9	Double Tri.	9QD	13.0*	0.450	Ver. Defl. Osc. Ver. Defl. Amp.	1.5 11.0	Characteristics Same as Type 6GF7. (13GF7 Designed for Series String Receivers.)									
13J10	Comp. T-9	Double Pent.	12BT	13.2*	0.450	FM Disc. Beam Amp. 10.0	Characteristics Same as Type 6J10. (13J10 Designed for Series String Receivers.)									
14A7	Lock-in	Pentode	8V	12.6	0.150	R-F Amp.	4.4	Characteristics Same as Type 7A7.									
14AF7/XXD	Lock-in	Duotriode	8AC	12.6	0.150	Amplifier	2.75	Characteristics Same as Type 7AF7.									
14B6	Lock-in	Duodiode Tri.	8W	12.6	0.150	Det. Amp.	0.55	Characteristics Same as Type 7B6.									
14C5	Lock-in	Beam Pent.	6AA	12.6	0.225	Power Amp.	13.2	Characteristics Same as Type 7C5.									
14C7	Lock-in	Pentode	8V	12.6	0.150	R-F Amp.	1.1	100 250	1.0 3.0	100 100	5.7 2.2	1.8 0.7	400000 1.0 Meg.	2275 1575	
14F7	Lock-in	Duotriode	8AC	12.6	0.150	A-F Amp.	1.1	Characteristics Same as Type 7F7.									
14F8	Lock-in	Duotriode	8BW	12.6	0.150	Osc. Amp.	3.85	Characteristics Same as Type 7F8.									
14GT8	T-6½	Duodiode Triode	9KR	14	0.150	FM Det. Audio Amp.	1.1	250	3.0	0.7	...	72000	1000	72
14JG8	T-6½	Duodiode Triode	9KR	14	0.150	FM Det./A-F Amp.	1.1	250	2.0	2	...	41000	2200	90
14Q7	Lock-in	Heptode	8AL	12.6	0.150	Converter	1.1	Characteristics Same as Type 7Q7.									
14R7	Lock-in	Duodi. Pent.	8AE	12.6	0.150	Det. Amp.	2.2	Characteristics Same as Type 7R7.									
15AF11	Comp. T-9	Pentode Duotriode	12DP	14.7*	0.450	Video Amp. AGC Keyer Sync. Sep.	Characteristics Same as Type 6AF11. (15AF11 Designed for Series String Receivers.)									
15BD11	Comp. T-9	Hi Mu Triode Med. Mu Tri. Sharp Cutoff Pentode	12DP	14.7*	0.450	Gen. Pur. Amp. Sync. Sep. Video Amp.	2.0 1.5 4.0	Characteristics Same as Type 6BD11. (15BD11 Designed for Series String Receivers.)									
15CW5	T-6½	Beam Pent.	9CV	15	0.300	A-F Pwr. Amp.	13	Characteristics Same as Type 6CW5. (15CW5 Designed for Series String Receivers.)									
15EA7	T-9	Duotriode	8BD	14.8*	0.450	Vert. Defl. Amp./Osc.	1.0 10	Characteristics Same as Type 6EA7. (15EA7 Designed for Series String Receivers.)									

(1) See Frontal Section. (2) Design Maximum Values. (3) Has Special Mechanical and/or Life Characteristics. (4) Average Contact Potential Bias Developed Across Specified Grid Resistor. * Controlled Heater Warm-up Time (applies to parallel connections of types having a tapped heater.)
 † Maximum Signal. ‡ Filamentary Type. †† Plate to Plate. ‡‡ Cathode Resistor (ohms).

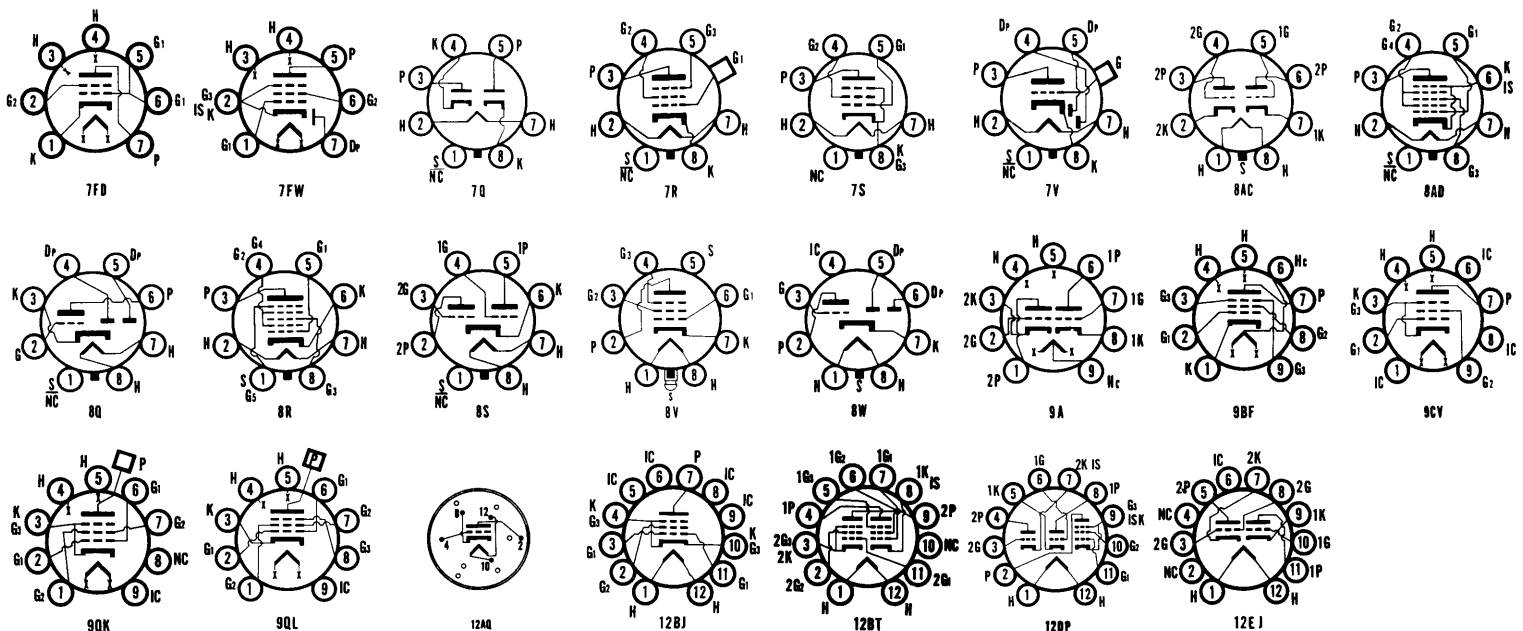

SYLVANIA TUBES

TYPE	CONSTRUCTION			EMITTER		USE	Plate Diss. Watts ²	Plate Volts	Negative Grid Volts	Screen Volts	Plate Current Ma.	Screen Current Ma.	Plate Resis. Ohms	Transcon-ductance Micros.	Ampli-fication Factor	Ohms Load for Stated Power Output	Power Output Milli-watts
	Bulb Size or Style ¹	Class	Basing Diag.	Volts	Amps.												
15FM7	Comp. T-9	Double Tri.	12EJ	14.8*	0.450	Ver. Defl. Osc. Ver. Defl. Amp.	1.0	10.0	Characteristics Same as Type 6FM7. (15FM7 Designed for Series String Receivers.)								
15FY7	Comp. T-9	Double Tri.	12EO	14.7*	0.450	Ver. Defl. Osc. Ver. Defl. Amp.	1.0	7.0	Characteristics Same as Type 6FY7. (15FY7 Designed for Series String Receivers.)								
15HB6	T-6½	Beam Pent.	9PU	14.7*	0.300	Ver. Defl. Amp.	10	Characteristics Same as Type 6HB6. (15HB6 Designed for Series String Receivers.)									
15KY8	Novar T-9	Hi Mu Triode Beam Pentode	9QT	15.0*	0.450	Ver. Defl. Osc. Ver. Defl. Amp.	1.5	250	3	1.4	40000	1600	64			
15EW6	T-5½	Pentode	7CM	15.	0.150	VHF Amp.	3.1	125	56 [■]	125	11	3.2	200000	14000		
16GK6	T-6½	Beam Pent.	9GK	16*	0.300	Power Amp.	13.2	Characteristics Same as Type 6GK6. (16GK6 Designed for Series String Receivers.)									
16GY5	Comp. T-12	Beam Pent.	12DR	15.8*	0.600	Horiz. Defl. Amp.	18	Characteristics Same as Type 6GY5. (16GY5 Designed for Series String Receivers.)									
17AV5GA	T-11 or T-12	Beam Pent.	6CK	16.8*	0.450	Horiz. Defl. Amplifier	12.1	Characteristics Same as Type 6AV5GA. (17AV5GA Designed for Series String Receivers.)									
17AX3	Comp. T-9	Diode	12BL	16.8*	0.450	T.V. Damper	5.3	Characteristics Same as Type 6AX3. (17AX3 Designed for Series String Receivers.)									
17AX4GT	T-9	Diode	4CG	16.8	0.450	T.V. Damper	5.28	Characteristics Same as Type 6AX4GT. (17AX4GT Designed for Series String Receivers.)									
17AX4GTA	T-9	Diode	4CG	16.8*	0.450	T.V. Damper	5.3	Maximum Peak Inverse Plate Voltage = 5000 Volts. Maximum D.C. Plate Current = 125 Ma.									
17AY3	Novar T-9	Diode	9HP	16.8*	0.450	T.V. Damper	6.5	Characteristics and Ratings Same as Type 6AY3. (17AY3 Designed for Series String Receivers.)									
17BE3	Comp. T-9	Diode	12BL	16.8*	0.450	T.V. Damper	6.5	Characteristics Same as Type 6BE3. (17BE3 Designed for Series String Receivers.)									
17BF11	Comp. T-9	Power Pent. Dual Control Pentode	12EZ	16.8*	0.450	A-F Out. Amp. FM Det.	6.5	1.7	Characteristics Same as Type 6BF11. (17BF11 Designed for Series String Receivers.)								
17BH3	Novar T-9	Diode	9HP	17*	0.600	T.V. Damper	6.5	Characteristics and Ratings Same as Type 6BH3.									
17BQ6GTB	T-12	Beam Pent.	6AM	16.8*	0.450	Horiz. Defl. Amplifier	12.1	Characteristics Same as Type 6BQ6GTB. (17BQ6GTB Designed for Series String Receivers.)									
17BR3	T-6½	Diode	9CB	16.8*	0.450	T.V. Damper	6.5	Characteristics Same as Type 6BR3. (17BR3 Designed for Series String Receivers.)									
17BS3	Novar T-9	Diode	9HP	16.8*	0.450	T.V. Damper	6.0	Characteristics Same as Type 6BS3. (17BS3 Designed for Series String Receivers.)									
17C5	T-5½	Beam Pent.	7CV	16.8*	0.450	Power Amp.	6.6	Characteristics Same as Type 12C5. (17C5 Designed for Series String Receivers.)									
17C8	T-6½	Duodi. Pent.	9T	17	0.100	Det. R-F Amp.	1.65	200	295 [■]	60	5	1.75	1 Meg.	2200		
17C9A	T-6½	Duotrode	10F	16.8*	0.150	VHF Amp.	2.5	Characteristics Same as Type 6C9. (17C9A Designed for Series String Receivers.)									
17CA5	T-5½	Beam Pent.	7CV	16.8*	0.450	Power Amp.	5.5	Characteristics Same as Type 12CA5. (17CA5 Designed for Series String Receivers.)									
17CU5	T-5½	Pentode	7CV	16.8*	0.450	Power Amp.	6.6	Characteristics Same as Type 6CU5. (17CU5 Designed for Series String Receivers.)									
17D4	T-9	Diode	4CG	16.8*	0.450	T.V. Damper	5.5	Maximum Peak Inverse Plate Voltage = 4400 Volts. Maximum D.C. Plate Current = 155 Ma. Characteristics Same as Type 12D4. (17D4 Designed for Series String Receivers.)									
17DE4	T-9	Diode	4CG	17.0*	0.600	T.V. Damper	6.5	Characteristics and Ratings Same as 6DE4. (17DE4 Designed for Series String Receivers.)									
17DM4	T-9	Diode	4CG	16.8*	0.450	T.V. Damper	6.5	Characteristics Same as Type 6DM4. (17DM4 Designed for Series String Receivers.)									
17DM4A	T-9	Diode	4CG	16.8*	0.450	T.V. Damper	6.5	Characteristics Same as Type 6DM4A. (17DM4A Designed for Series String Receivers.)									
17DQ4	T-9	Diode	4CG	16.8*	0.450	T.V. Damper	6.0	Characteristics Same as Type 6DQ4. (17DQ4 Designed for Series String Receivers.)									
17DQ6	T-12	Beam Pent.	6AM	16.8*	0.450	Horiz. Defl. Amplifier	16.5	Characteristics Same as Type 6DQ6. (17DQ6 and 17DQ6A Designed for Series String Receivers.)									
17DQ6A	T-12	Beam Pent.	6AM	16.8*	0.450	Horiz. Defl. Amplifier	18	Characteristics Same as Type 6DQ6A.									
17DQ6B	T-12	Beam Pent.	6AM	16.8*	0.450	Horiz. Defl. Amplifier	18	Characteristics Same as Type 6DQ6B. (17DQ6B Designed for Series String Receivers.)									
17GE5	Comp. T-12	Beam Pent.	12BJ	16.8*	0.450	Horiz. Defl. Amp.	17.5	Characteristics Same as Type 6GE5. (17GE5 Designed for Series String Receivers.)									
17GJ5	Novar T-12	Beam Pent.	9QK	16.8*	0.450	Horiz. Defl. Amplifier	17.5	Characteristics Same as Type 6GJ5. (17GJ5 Designed for Series String Receivers.)									
17GT5	Novar T-12	Beam Pent.	9NZ	16.8*	0.450	Horiz. Defl. Amplifier	17.5	Characteristics Same as Type 6GT5. (17GT5 Designed for Series String Receivers.)									
17GV5	Comp. T-12	Beam Pent.	12DR	16.8*	0.450	Horiz. Defl. Amp.	17.5	Characteristics Same as Type 6GV5. (17GV5 Designed for Series String Receivers.)									
17GW6	T-12	Beam Pent.	6AM	16.8*	0.450	Horiz. Defl. Amplifier	17.5	Characteristics Same as Type 6GW6. (17GW6 Designed for Series String Operation.)									
17H3	T-6½	Diode	9FK	17.5*	0.300	T.V. Damper	3.0	Maximum Peak Inverse Plate Voltage = 2000 Volts. Maximum D.C. Output Current = 75 Ma.									

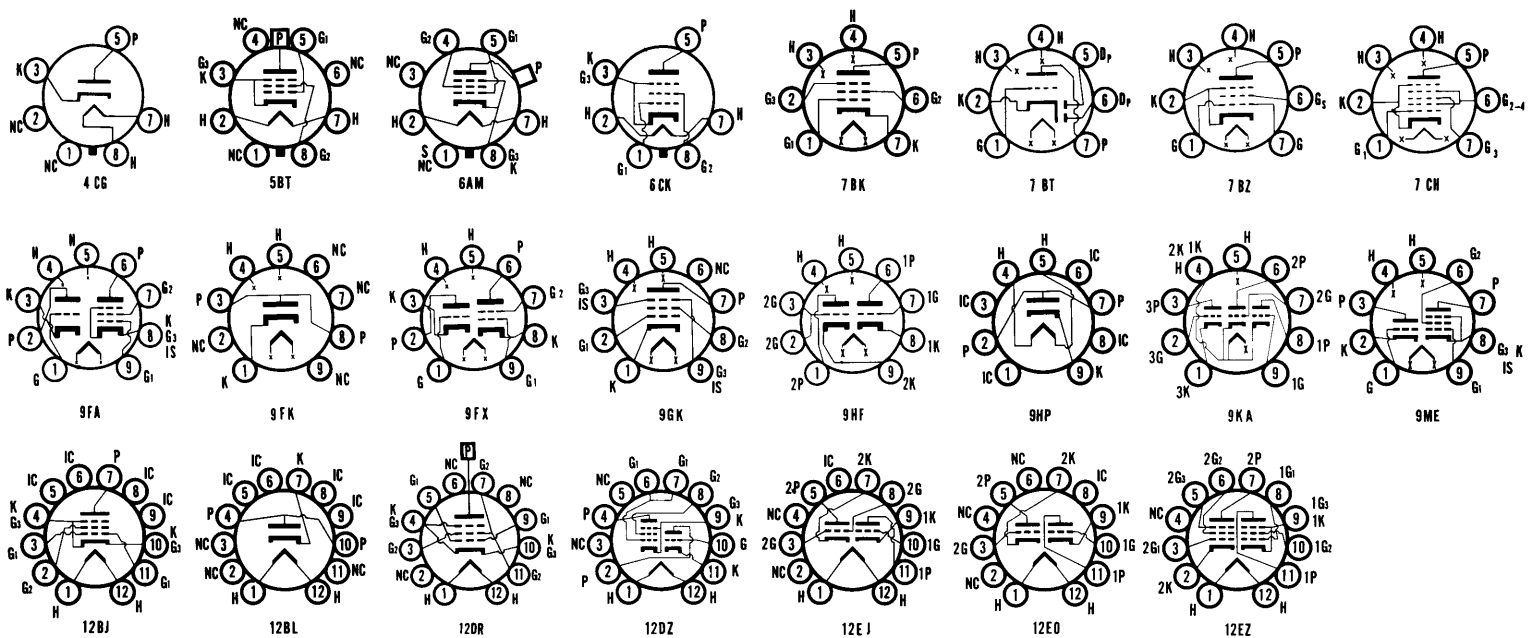

AVERAGE CHARACTERISTICS

TYPE	CONSTRUCTION			EMITTER		USE	Plate Diss. Watts ²	Plate Volts	Negative Grid Volts	Screen Volts	Plate Current Ma.	Screen Current Ma.	Plate Resis. Ohms	Transconductance Micros.	Amplification Factor	Ohms Load for Stated Power Output	Power Output Milli-watts	
	Bulb Size or Style ¹	Class	Basing Diag.	Volts	Amps.													
17HC8	9-T9	Tri. Pentode	9EX	16.8*	0.450	Vert. Defl. Osc./Amp.	1.0											Characteristics Same as Type 6HC8. (17HC8 Designed for Series String Receivers.)
17JB6	Novar T-12	Pentode	9QL	16.8*	0.450	Horiz. Defl. Amp.	17.5											Characteristics Same as Type 6JB6. (17JB6 Designed for Series String Receivers.)
17JK8	T-6½	Duotriode	9AJ	16.8*	0.150	FM Osc. FM Amp.	1.0 2.0	100 135	1.0 1.2	5.3 10	8000 5400	6800 13000	55 70	
17JZ8	Comp. T-9	Tri. Pentode	12DZ	16.8*	0.450	Vert. Osc. Vert. Defl. Amp	1.0											Characteristics Same as Type 6JZ8. (17JZ8 Designed for Series String Receivers.)
17L6GT	T-9	Beam Pent.	7S	16.8*	0.450	Power Amp.	11											Characteristics Same as Type 25L6GT. (17L6GT Designed for Series String Receivers.)
17LD8	T-9	Tri. Pentode	9QT	16.8*	0.450	Vert. Osc. Vert. Defl. Amp.	1.0 7.0	150 120	5 8 100	3.3 46.0 4	11300 11700	1900 7100	21.5	
17R5	T-5½	Beam Pent.	7CV	16.8*	0.450	Vert. Defl. Amplifier	4.95											Characteristics Same as Type 12R5. (17R5 Designed for Series String Receivers.)
17W6GT	T-9	Beam Pent.	7S	16.8*	0.450	A-F Pwr. Amp.	12											Characteristics Same as Type 6W6GT. (17W6GT Designed for Series String Receivers.)
18A5	T-9	Beam Pent.	6CK	18.5*	0.300	Horiz. Defl. Amplifier	9.0											Max. Peak Positive Pulse Plate Voltage = 3000 Volts. Max. D.C. Cathode Current = 90 Ma.
18DZ8	T-6½	Tri. Beam Pentode	9EX	18.0	0.300	A-F Voltage Amp. and Power Amp.	.825 7.15											Characteristics Same as Type 6DZ8. (18DZ8 Designed for Series String Receivers.)
18FW6	T-5½	Pentode	7BK	18.0	0.100	R-F or I-F Amplifier	2.5	100	68 [■]	100	11	4.4	250000	4400	
18FX6	T-5½	Heptode	7CH	18.0	0.100	Converter	1.0	100	1.5	100	2.3	6.2	400000	480	Osc. Grid Res. = 20000 Ohms Osc. Grid Current = 0.5 Ma.
18FY6	T-5½	Duodiode Tri.	7BT	18.0	0.100	A-F Amp.	0.5	100	1.0	0.6	77000	1300	100	
18GD6	T-5½	Pentode	7BK	18.0	0.100	R-F Amp.	2.5	100	150 [■]	100	5.0	2.0	500000	4300	
18GE6	T-5½	Duodiode Tri.	7BT	18.0	0.100	Det. Amp.	0.5	100	1.0	1.0	40000	1700	70	
18HB8	T-6½	Triode Beam Pentode	9ME	18	0.300	Voltage Amp. S.T. A1 Amp.	.75 6.5	115 115	410 [■] 150 [■] 115	2.5 33 7.5	3900 6250	74 3500	1000	
19AQ5	T-5½	Beam Pent.	7BZ	18.9	0.150	Power Amp.	13.2											Same as 6AQ5.
19AU4	T-9	Diode	4CG	18.9*	0.600	T.V. Damper	6.6											Characteristics Same as Type 6AU4GT. (19AU4 Designed for Series String Receivers.)
19AU4GTA	T-9	Diode	4CG	18.9*	0.600	T.V. Damper	6.6											Characteristics Same as Type 6AU4GTA. (19AU4GTA Designed for Series String Receivers.)
19BG6G	ST-16 T-12	Beam Pent.	5BT	18.9	0.300	Horiz. Defl. Amplifier	22											Characteristics Same as Type 6BG6G.
19C8	T-6½	Triple Dio. Tri.	9E	18.9	0.150	Det. Amp.	1.1	100	1.0	0.5	80000	1250	100	
19CL8A	T-6½	Tri. Tetrode	9FX	18.9	0.150	VHF Osc. VHF Amp.	2.97 3.0											Characteristics Same as Type 6CL8A.
19DE7	T-6½	Duotriode	9HF	19.4*	0.300	Vert. Defl. Amp. and Osc.	7.0 1.5											Characteristics Same as Type 6DE7. (19DE7 Designed for Series String Receivers.)
19EA8	T-6½	Tri. Pentode	9AE	18.9	0.150	Tri. VHF Amp. Pent. Amp.	3.0 3.1											Characteristics Same as Type 6EA8.
19EW7	T-9	Duotriode	9HF	18.9*	0.300	Vert. Osc. Vert. Defl. Amp.	1.5 10.0											Characteristics Same as Type 6EW7. (19EW7 Designed for Series String Receivers.)
19EZ8	T-6½	Triple Triode	9KA	18.9	0.150	VHF Amp.	2.0	125	1.0	4.2	13600	4200	57	
19GQ7	T-6½	Triple Diode	9QM	18.9	0.150	AM Det. FM Ratio Det.											Characteristics Same as Type 6GQ7.
19HR6	T-5½	Pentode	7BK	18.9*	0.150	FM I-F Amp.	3.0											Characteristics Same as Type 6HR6. (19HR6 Designed for Series String Receivers.)
19HS6	T-5½	Pentode	7BK	18.9*	0.150	I-F Amp.	3.0											Characteristics Same as Type 6HS6. (19HS6 Designed for Series String Receivers.)
19HV8	T-6½	Tri. Pentode	9FA	18.9	0.150	A-F Amp. I-F Amp.	0.5 3.0	100 125	1.0 1.0 125	0.8 12 4	54000 200000	1300 6500	70	

(1) See Frontal Section. (2) Design Maximum Values. † Maximum Signal. (3) Has Special Mechanical and/or Life Characteristics. (4) Average Contact Potential Bias Developed Across Specified Grid Resistor. †† Plate to Plate. ■ Cathode Resistor (ohms).

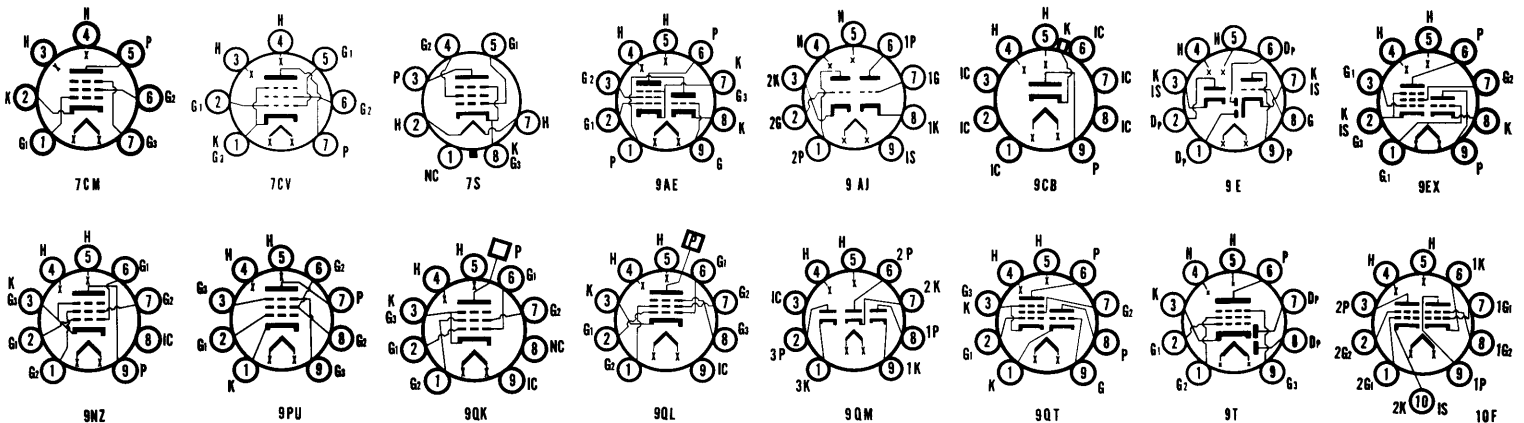

SYLVANIA TUBES

TYPE	CONSTRUCTION			EMITTER		USE	Plate Diss. Watts?	Plate Volts	Negative Grid Volts	Screen Volts	Plate Current Ma.	Screen Current Ma.	Plate Resis. Ohms	Transconductance Micros.	Amplification Factor	Ohms Load for Stated Power Output	Power Output Milli-watts
	Bulb Size or Style ¹	Class	Basing Diag.	Volts	Amps.												
19J6	T-5½	Duotriode	7BF	18.9	0.150	VHF Osc. Amplifier	1.65	Characteristics Same as Type 6J6.									
19KG8	T-6½	Tri. Pentode	9LY	18.9	0.150	VHF Osc. VHF Mixer	2.5 2.5	125	1	125	13.5 12.0	4.0	5400 200000	8500 7500	46
19Q9	T-6½	Tri. Pentode	10H	18.9*	0.150	Auto. Mixer FM R-F Amp.	3.0 2.5	125 125	1	125	12.0 14.0	4.0	200000 5000	6500 8000	40
19T8	T-6½	Triple Diode Triode	9E	18.9	0.150	Det. Amp.	1.1	Characteristics Same as Type 6T8.									
19V8	T-6½	Triple Diode Triode	9AH	18.9	0.150	Det. Amp.	1.1 250	100 3.0	0.8 1.0	54000 58000	1300 1200	70 70	
19X8	T-6½	Tri. Pentode	9AK	18.9	0.150	VHF Osc. Amplifier	1.65 2.2	Characteristics Same as Type 6X8.									
20EQ7	T-6½	Diode Pent.	9LQ	20	0.100	Det. R-F Amp.	3.0	Characteristics Same as Type 6EQ7.									
20EZ7	T-6½	Duotriode	9PG	20*	0.100	A-F Amp.	1.2	100 250	1.0 2.0	0.5 1.2	80000 62500	1250 1600	100 100
21EX6	T-12	Beam Pent.	5BT	21.5*	0.600	Horiz. Defl. Amplifier	22	Characteristics Same as Type 6EX6. (21EX6 Designed for Series String Receivers.)									
21GY5	Comp. T-12	Beam Pent.	12DR	21.0*	0.450	Horiz. Defl. Amp.	18	Characteristics Same as Type 6GY5. (21GY5 Designed for Series String Receivers.)									
21HB5	Comp. T-12	Beam Pent.	12BJ	21.0*	0.450	Horiz. Defl. Amp.	18	Characteristics Same as Type 6HB5. (21HB5 Designed for Series String Receivers.)									
21HD5	Comp. T-12	Beam Pent.	12ES	21.5*	0.600	Horiz. Defl. Amp.	24	Characteristics Same as Type 6HD5. (21HD5 Designed for Series String Receivers.)									
21HJ5	Comp. T-12	Beam Pent.	12ES	21.5*	0.600	Horiz. Defl. Amp.	24	Characteristics Same as Type 6HJ5. (21HJ5 Designed for Series String Receivers.)									
22BH3	Novar T-9	Diode	9HP	22.4*	0.450	T.V. Damper	6.5	Characteristics and Ratings Same as Type 6BH3.									
22DE4	T-9	Diode	4CG	22*	0.450	T.V. Damper	6.5	Characteristics and Ratings Same as Type 6DE4. (22DE4 Designed for Series String Receivers.)									
22JG6	Novar T-12	Beam Pent.	9QU	22.0*	0.450	Horiz. Defl. Amp.	17	Max. Peak Positive Pulse Plate Voltage = 6500 Volts. Max. Cathode Current = 275 Ma.									
25AV5GA	T-11 or T-12	Beam Pent.	6CK	25.0	0.300	Horiz. Defl. Amplifier	12.1	Characteristics Same as Type 6AV5GA.									
25AX4GT	T-9	Diode	4CG	25.0	0.300	T.V. Damper	5.28	P.I.V. = 4000 Volts Max. D.C. Plate Current = 125 Ma. Max.									
25BK6	T-6½	Beam Pent.	9BQ	25.0	0.300	Power Amp.	9.9	Characteristics Same as Type 6BK5.									
25BQ6GA	T-11	Beam Pent.	6AM	25.0	0.300	Horiz. Defl. Amplifier	12.1	Characteristics and Ratings Same as Type 6BQ6G.									
25BQ6GT	T-9	Beam Pent.	6AM	25.0	0.300	Horiz. Defl. Amplifier	12.1	Characteristics Same as Type 6BQ6GT.									
25BQ6GTB	T-9	Beam Pent.	6AM	25.0	0.300	Horiz. Amp.	12.1	Characteristics Same as Type 6BQ6GTB.									
25BR3	T-6½	Diode	9CB	25.0*	0.300	T.V. Damper	6.5	Characteristics Same as Type 6BR3. (25BR3 Designed for Series String Receivers.)									
25C5	T-5½	Beam Pent.	7CV	25.0	0.300	Power Amp.	6.6	120	8	110	49	4.0	10000	7500	2500	2300
25CA5	T-5½	Beam Pent.	7CV	25.0	0.300	Power Amp.	5.5	Characteristics Same as Type 6CA5.									
25CD6GB	T-12	Beam Pent.	5BT	25.0*	0.600	Horiz. Defl. Amplifier	22	Characteristics Same as Type 6CD6GA. (25CD6GB Designed for Series String Receivers.)									
25DK4	T-5½	Diode	5BQ	25	0.150	H-W Rect.	117 A.C. Volts, RMS, 90 Ma. D.C. Output. (Condenser Input to Filter.)									
25DN6	T-12	Beam Pent.	5BT	25.0*	0.600	Horiz. Defl. Amplifier	16.5	Peak Positive Pulse Plate Voltage = 6600 Volts Max. D.C. Cathode Current = 200 Ma. (25DN6 Designed for Series String Receivers.)									
25DQ6A	T-12	Beam Pent.	6AM	25*	0.300	Horiz. Defl. Amplifier	16.5	Characteristics Same as Type 6DQ6A. (25DQ6A Designed for Series String Receivers.)									
25DT5	T-6½	Beam Pent.	9HN	25*	0.300	Vert. Defl. Amplifier	9.0	Characteristics Same as Type 6DT5. (25DT5 Designed for Series String Receivers.)									
25EC6	T-12	Beam Pent.	5BT	25.0*	0.600	Horiz. Defl. Amp.	10.0	Max. Peak Positive Pulse Plate Voltage = 7000 Volts. Max. Cathode Current = 200 Ma.									
25EH5	T-5½	Beam Pent.	7CV	25	0.300	S.T. A1 Amp.	5.5	Characteristics Same as Type 6EH5.									
25F5	T-5½	Beam Pent.	7CV	25.0	0.150	Power Amp.	4.5	110	7.5	110	36.0	7.0	16000	5800	2500	1200

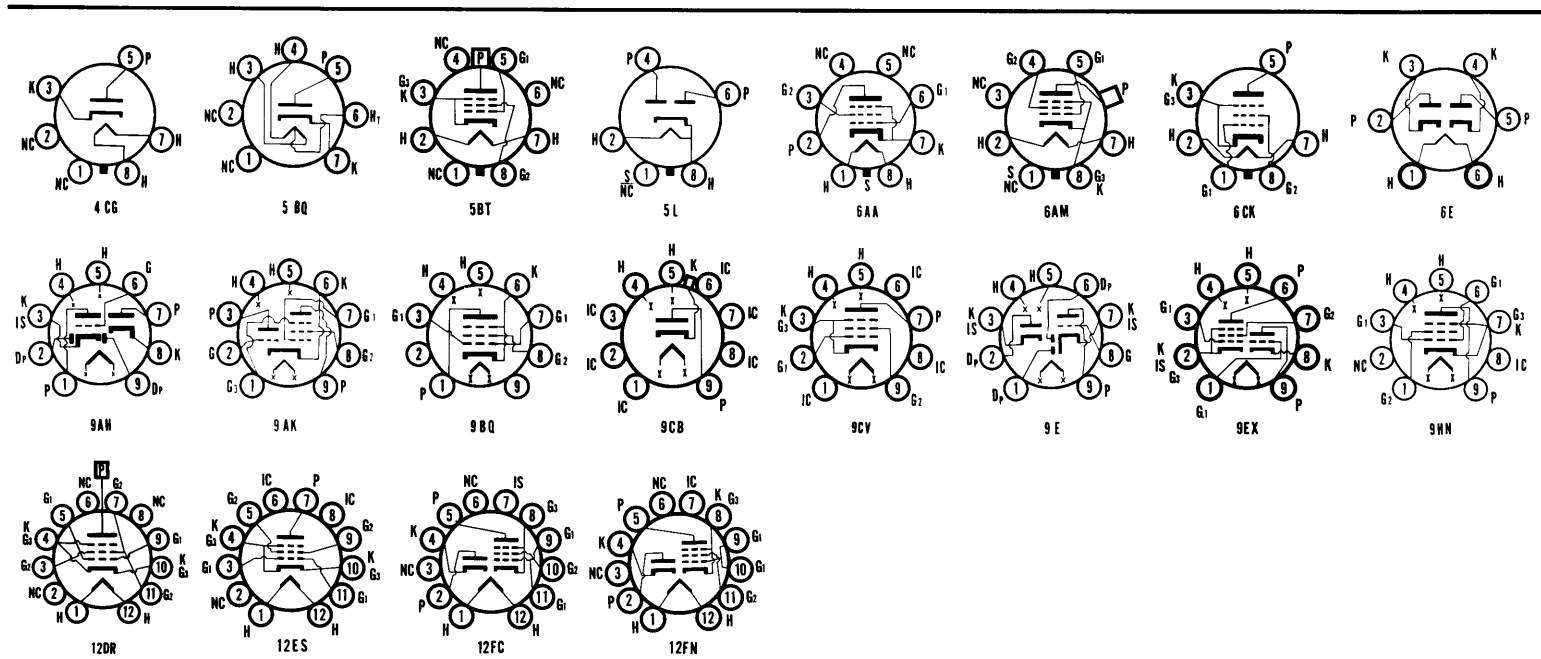

AVERAGE CHARACTERISTICS

TYPE	CONSTRUCTION			EMITTER		USE	Plate Diss. Watts ²	Plate Volts	Negative Grid Volts	Screen Volts	Plate Current Ma.	Screen Current Ma.	Plate Resis. Ohms	Transconductance Micros.	Amplification Factor	Ohms Load for Stated Power Output	Power Output Milli-watts
	Bulb Size or Style ¹	Class	Basing Diag.	Volts	Amps.												
25F5A	T-5½	Beam Pent.	7CV	25.0	0.150	Power Amp.	5.0	110	7.5	110	45.0	7.3	13000	6400	2500	1500
25L6GT	T-9	Beam Pent.	7S	25.0	0.300	Power Amp. P-PA ¹ Amp.	11	110	7.5	110	49.0	4.0	13000	8000	2000	2100
25W4GT	T-9	Diode	4CG	25.0	0.300	H-W Rect.	3.85	350 A.C. Volts RMS, 125 Ma. D.C. Output. Condenser Input to Filter.									
25W6GT	T-9	Beam Pent.	7S	25.0	0.300	Power Amp.	11	110	7.5	110	50	4.0	13000	8000	2000	2100
25Z5	ST-12	Duodiode	6E	25.0	0.300	Doubler	Characteristics Same as Type 25Z6GT.									
25Z6GT	T-9	Duodiode	7Q	25.0	0.300	Doubler H-W Rect.	117 A.C. Volts Per Plate, RMS, 75 Ma. Output Current. 235 A.C. Volts, RMS, 75 Ma. Output Current Per Plate.									
27GB5	Magnoval T-9	Beam Pent.	9HN	27	0.300	Horiz. Defl. Amplifier	17	Characteristics and Ratings Same as Type 6GB5. (27GB5 Designed for Series String Receivers.)									
28D7 28D7W (3) GB-28D7W (3)	Lock-in	Duo. Beam Pentode	8BS	28.0	0.400	Amplifier (per section) P.P. A2 Total	3.0	28	390 [■]	28	9.0	0.7	4200	3400	4000	80
28GB5	Magnoval T-9	Beam Pent.	9HN	28	0.300	Horiz. Defl. Amplifier	17	Characteristics and Ratings Same as Type 6GB5.									
28HD5	Comp. T-12	Beam Pent.	12ES	28.0*	0.450	Horiz. Defl. Amp.	24.0	Characteristics Same as Type 6HD5. (28HD5 Designed for Series String Receivers.)									
30AG11	Comp. T-9	Duodiode Duotriode	12DA	30.0	0.150	FM Multiplex Service	2.0	Characteristics Same as Type 6AG11.									
30CW5	T-6½	Beam Pent.	9CV	30.0	0.150	S.T. A1 Amp. S.T. A1 Amp. P.P. AB1 Amp.	13	Characteristics Same as Type 6CW5.									
30HD5	Comp. T-12	Beam Pent.	12ES	30.0*	0.450	Horiz. Defl. Amp.	24.0	Characteristics Same as Type 6HD5. (30HD5 Designed for Series String Receivers.)									
30HJ5	Comp. T-12	Beam Pent.	12ES	30.0*	0.450	Horiz. Defl. Amp.	24.0	Characteristics Same as Type 6HJ5. (30HJ5 Designed for Series String Receivers.)									
32ET5	T-5½	Beam Pent.	7CV	32	0.100	Power Amp.	5.4	110	7.5	110	30	2.8	21500	5500	2800	1200
33GT7	Comp. T-12	Diode Pent.	12FC	33.6	0.450	T.V. Damper Horiz. Defl. Amp.	3.5	Max. Peak Inverse Plate Voltage = 2500 Volts. Max. D.C. Cathode Current = 125 Ma. Max. Peak Positive Pulse Plate Voltage = 3500 Volts. Max. Cathode Current = 140 Ma.									
33GY7	Comp. T-12	Diode Pent.	12FN	33.6*	0.450	T.V. Damper Horiz. Defl. Amp.	3.8	Max. Peak Inverse Plate Voltage = 4200 Volts. Max. D.C. Cathode Current = 135 Ma. Max. Peak Positive Pulse Plate Voltage = 5000 Volts. Max. Cathode Current = 155 Ma.									
EL34/6CA7	T-10 (SP)	Beam Pent.	8ET	6.3	1.500	S.T. A1 Amp. P.P. AB1 Amp.	27.5	250	13.5	250	100	15	15000	11000	2000	11000
GZ34	T-11	Duodiode	5L	5.0 [♦]	1.900	F-W Rect.	Characteristics and Ratings Same as Type 5AR4.									
34GD5	T-5½	Beam Pent.	7CV	34	0.100	S.T. A1 Amp.	5.0	110	7.5	110	35	3	13000	5700	2500	1300
35A5	Lock-in	Beam Pent.	6AA	35.0	0.150	Power Amp.	9.35	110	7.5	110	40.0	3.0	14000	5800	2500	1500
35B5	T-5½	Beam Pent.	7BZ	35.0	0.150	Power Amp.	4.95	110	7.5	110	40.0	3.0	5800	2500	1500
35C5	T-5½	Beam Pent.	7CV	35.0	0.150	Power Amp.	4.95	110	7.5	110	40	3.0	5800	2500	1500
35CD6GA	T-12	Beam Pent.	5BT	35.0*	0.450	Horiz. Defl. Amplifier	22	Characteristics Same as Type 6CD6GA. (35CD6GA Designed for Series String Receivers.)									
35DZ8	T-6½	Tri. Beam Pentode	9EX	35	0.150	A-F Voltage Amp. and Power Amp.	.825	Characteristics Same as Type 6DZ8. (35DZ8 Designed for Series String Receivers.)									
35EH5	T-5½	Beam Pent.	7CV	35	0.150	A-F Pwr. Amp.	5.5	Characteristics Same as Type 6EH5.									
35GL6	T-5½	Beam Pent.	7FZ	35	0.150	S.T. A1 Amp.	5.5	110	7.5	110	45-47†	3-9†	12000	7500	2500	1800

(1) See Frontal Section. (2) Design Maximum Values. (3) Has Special Mechanical and/or Life Characteristics. (4) Average Contact Potential Bias Developed Across Specified Grid Resistor. * Controlled Heater Warm-up Time (applies to parallel connections of types having a tapped heater.)
 † Maximum Signal. ‡ Filamentary Type. † Conversion Transconductance. ‡ Plate to Plate. † Cathode Resistor (ohms).

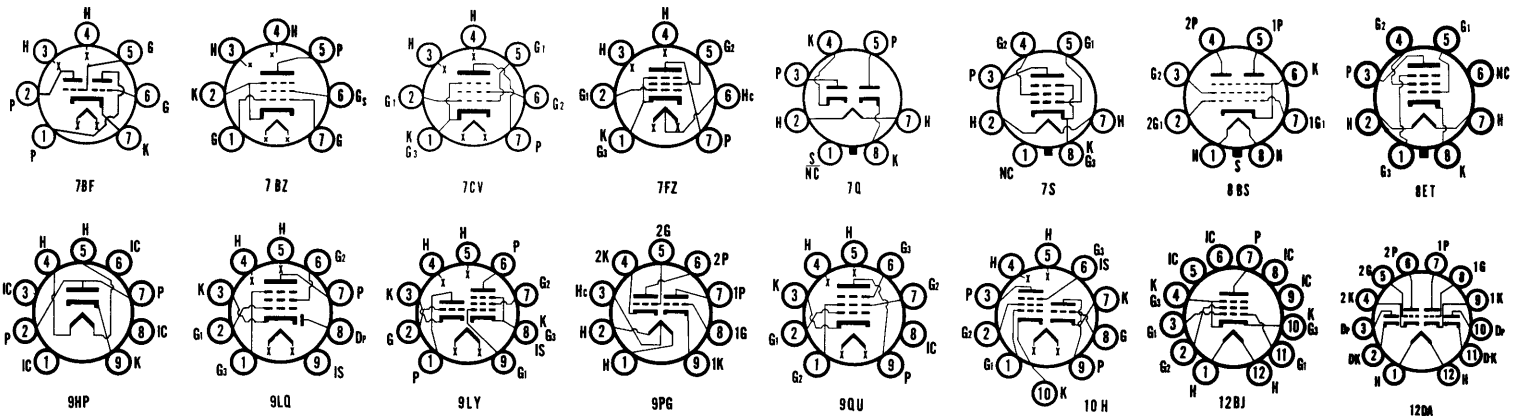

SYLVANIA TUBES

TYPE	CONSTRUCTION			EMITTER		USE	Plate Diss. Watts ²	Plate Volts	Negative Grid Volts	Screen Volts	Plate Current Ma.	Screen Current Ma.	Plate Resis. Ohms	Transcon-ductance Micros.	Amplification Factor	Ohms Load for Stated Power Output	Power Output Milli-watts
	Bulb Size or Style ¹	Class	Basing Diag.	Volts	Amps.												
35HB8	T-6½	Triode Beam Pent.	9ME	35	0.150	Voltage Amp. S.T. A1 Amp.	.75 6.5	Characteristics Same as Type 18HB8.									
35L6GT	T-9	Beam Pent.	7S	35.0	0.150	Power Amp.	9.35	110 200	7.5 8.0	110 110	40.0 43.0	3.0 2.0	14000 34000	5800 6100	2500 5000	1500 3000
35W4	T-5½	Diode	5BQ	35.0	0.150	H-W Rect.	117 A.C. Volts, RMS, 60 Ma. Output Current with Panel Lamp. 117 A.C. Volts, RMS, 100 Ma. Output Current without Panel Lamp.									
35Y4	Lock-in	Diode	5AL	35.0	0.150	H-W Rect.	235 Max. A.C. Volts, RMS, 60 Ma. Output Current with Panel Lamp. 235 Max. A.C. Volts, RMS, 100 Ma. Output Current without Panel Lamp.									
35Z3	Lock-in	Diode	4Z	35.0	0.150	H-W Rect.	235 Max. A.C. Volts Per Plate, RMS, 100 Ma. Output Current. Condenser Input to Filter									
35Z5GT	T-9	Diode	6AD	35.0	0.150	H-W Rect.	Characteristics Same as Type 35Y4.									
36AM3	T-5½	Diode	5BQ	36	0.100	H-W Rect.	117 A.C. Volts, RMS, 75 Ma. Condenser Input to Filter.									
36AM3A	T-5½	Diode	5BQ	36	0.100	H-W Rect.	120 A.C. Volts Per Plate, RMS, 75 Ma. Condenser Input to Filter.									
EL37	Curved Bulb	Beam Pent.	7S	6.3	1.400	S.T. A1 Amp. P.P. AB1 Amp.	250 400	13.5 36	250 400	100 100-276†	13.5 12-72†	13500	11000	2500 3250†	11500 69000
40A1	T-9	Ballast	8ES	Horiz. Reg. Horiz. Reg.	Avg. Operating Current—0 Ma. at 20 Volts; 150 Ma. at 40 Volts; 155 Ma. at 60 Volts.									
40B2	T-9	Ballast	8ES	Horiz. Reg. Horiz. Reg.	Avg. Operating Current—140 Ma. at 20 Volts; 150 Ma. at 40 Volts; 155 Ma. at 60 Volts.									
40FR5	T-5½	Power Pent.	7CV	40	0.100	A-F Power Amplifier	5.2	110 115	7.5 180 ^m	110 115	32 34	3 7	20000	6000	2800 3200	1500 1300
41	ST-12	Power Pent.	6B	6.3	0.400	Power Amp.	9.35	Characteristics Same as Type 6K6GT.									
42	ST-14	Power Pent.	6B	6.3	0.700	Power Amp.	12.1	Characteristics Same as Type 6F6G.									
43	ST-14	Power Pent.	6B	25.0	0.300	Power Amp.	5.83	Characteristics Same as Type 25A6GT.									
45	ST-14	Triode	4D	2.5†	1.500	Power Amp.	11	180 250 275	31.5 50.0 56.0	31.0 34.0 36.0	1650 1610 1700	2125 2175 2050	3.5 3.5 3.5	2700 3900 4600	830 1600 2000
50A1	T-6½	Ballast	9CM	Fil. Ballast	Avg. Operating Current—59 Ma. at 30 Volts; 54 Ma. at 50 Volts; 56 Ma. at 65 Volts.									
50A5	Lock-in	Beam Pent.	6AA	50.0	0.150	Power Amp.	11	110 200	7.5 8.0	110 110	49.0 50.0	4.0 1.5	13000 28000	8000 8000	2000 4000	2100 3800
50AX6G	ST-14	Duodiode	7Q	50.0	0.300	F-W Rect.	Characteristics Same as Type 6AX6G.									
50B5	T-5½	Beam Pent.	7BZ	50.0	0.150	Power Amp.	6.6	120	8	110	49	4.0	10000	7500	2500	2300
50BK5	T-6½	Beam Pent.	9BQ	50.0	0.150	Power Amp.	9.9	250	5.0	250	35	3.5	0.1 Meg.	8500	6500	3500
50BM8	T-6½	Tri. Pentode	9EX	50	0.100	A-F Tri. Amp. Power Amp.	1.1 7.7	100 100 200	0 6 16 100 200	3.5 26 35 5 7	28000 15000 20000	2500 6800 6400	70 3900 5600 1050 3500
50C5	T-5½	Beam Pent.	7CV	50.0	0.150	Power Amp.	6.6	120	8	110	49.	4.0	10000	7500	2500	2300
50CA5	T-5½	Beam Pent.	7CV	50	0.150	Power Amp.	5.5	Characteristics Same as Type 6CA5.									
50DC4	T-5½	Diode	5BQ	50	0.150	H-W Rect.	117 A.C. Volts Per Plate, RMS, 110 Ma. Output Current. Heater Tap Voltage (Pin 4 to Pin 6) = 7.5 Volts.									
50EH5	T-5½	Beam Pent.	7CV	50	0.150	S.T. A1 Amp.	5.5	Characteristics Same as Type 6EH5.									
50FA5	T-5½	Beam Pent.	7CV	50	0.150	S.T. A1 Amp.	5.2	110	7.5	110	40	3	13000	5800	2500	1500
50FE5	T-6½	Beam Pent.	8KB	50	0.150	S.T. A1 Amp. P.P. AB1 Amp.	14.5	Characteristics Same as Type 6FE5.									
50FK5	T-5½	Power Pent.	7CV	50	0.100	S.T. A1 Amp.	5.0	110	62 ^m	110	32	8.5	14000	12800	3000	1200
50FY8	T-6½	Tri. Beam Pentode	9EX	50	0.150	Tri. Volt. Amp. Pent. S.T. A1 A. Pent. P.P. A1 A.	1.0 1.0 1.0	125 125 125	1.5 120 ^m 62 ^m 125 125	2.5 70-66† 10-19†	17000 5000 7500	2700 7500	46	2000 4000† 6000 3000 6000
50HC6	T-5½	Pentode	7FZ	50	0.150	S.T. A1 Amp.	5.5	110	62 ^m	115	42	11.5	11000	14600	3000	1.4
50L6GT	T-9	Beam Pent.	7S	50.0	0.150	Power Amp.	11	Characteristics Same as Type 25L6GT.									
50X6	Lock-in	Duodiode	7DX	50.0	0.150	H-W Rect. Doubler	235 Volts RMS Per Plate, 75 Ma. D.C. Output Per Plate. 117 Volts RMS Per Plate, 75 Ma. D.C. Output.									
50Y6GT	T-9	Duodiode	7Q	50.0	0.150	F-W Rect.	Characteristics Same as Type 25Z6GT.									

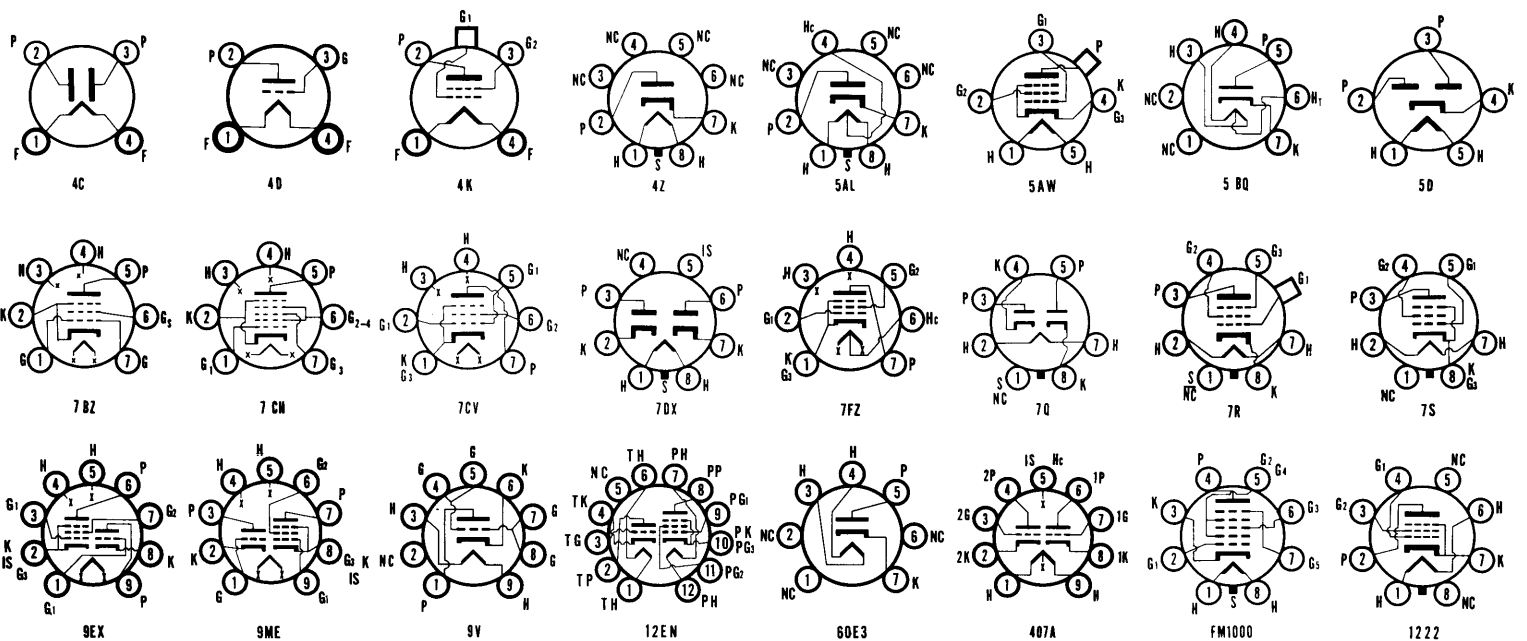

AVERAGE CHARACTERISTICS

TYPE	CONSTRUCTION			EMITTER		USE	Plate Diss. Watts [†]	Plate Volts	Negative Grid Volts	Screen Volts	Plate Current Ma.	Screen Current Ma.	Plate Res. Ohms	Transconductance Micros.	Amplification Factor	Ohms Load for Stated Power Output	Power Output Milli-watts	
	Bulb Size or Style [†]	Class	Basing Diag.	Volts	Amps.													
50Y7GT	T-9	Duodiode	8AN	46.0	0.150	Doubler H-W Rect.	117 A.C. Volts, RMS, 65 Ma. Output with Panel Lamp.										
56R9	Comp. T-9	Tri. Pentode	12EN	Tri. 14.0 Pent. 42.0	0.150 0.150	A-F Amp. Power Amp.	1.0 6.5	100 120	1500 [■] 8.0 110	0.6 50.0 8.5	55500 10000	1800 7500	100	2500	2300	
60E3	T-5½	Diode	60E3	60	0.150	H-W Rect.	117 Volts, RMS, 110 Ma. D.C. Output. Condenser Input.										
60FX5	T-5½	Pentode	7CV	60	0.100	S.T. A1 Pwr. Amplifier	5.5	110	62 [■]	115	36-35	10-12	17500	13500	3000	1300	
KT66	Curved Bulb	Beam Pent.	7S	6.3	1.270	S.T.A1 Amp. P.P.AB1 Amp.	250 450	15 250 [■]	250 415	85 105-125†	6.3 5-18†	22500	6300	2200 8000†	7250 30000	
75	ST-12	Duodiode Tri.	6G	6.3	0.300	Det. Amp.	250	2.0	0.9	91000	1100	100	
78	ST-12	Pentode	6F	6.3	0.300	R-F Amp.	3.0	90 180 250	3.0 3.0 3.0	90.0 75.0 100	5.4 4.0 7.0	1.3 1.0 1.7	300000 1 Meg. 800000	1275 1100 1450	
80	ST-14	Duodiode	4C	5.0	2.000	F-W Rect.	350 A.C. Volts Per Plate, RMS, 125 Ma. Output Current. Condenser Input to Filter.										
83	ST-16	Duodiode	4C	5.0	3.00	F-W Rect.	450 A.C. Volts Per Plate, RMS, 125 Ma. Output Current. Choke Input to Filter.										
84/6Z4	ST-12	Duodiode	5D	6.3	0.500	F-W Rect.	325 A.C. Volts Per Plate, RMS, 60 Ma. Output Current. Condenser Input to Filter.										
EL84/6BQ5	T-6½	Beam Pent.	9CV	6.3	0.760	Power Amp.	13.2	Characteristics Same as Type 6BQ5.										
EL86	T-6½	Beam Pent.	9CV	6.3	0.760	A-F Pwr. Amp.	13	Characteristics Same as Type 6CW5.										
EF86/6267	T-6½	Pentode	9CQ	6.3	0.200	A-F Amp.	1.1	250	2.0	140	3.0	0.6	2.5 Meg.	1800	
KT88	ST-16	Beam Pent.	7S	6.3	1.800	P.P.AB1 Amp.	450	65	450	100-240†	(Plate and Grid No. 2 Current.)	3800†	65000	
VR-90-105-150							Now Listed as OB3, OC3 and OD3.											
117L7/M7GT	T-9	Diode Beam Pentode	8AO	117	0.090	H-W Rect. Power Amp.	6.6	117 A.C. Volts, RMS, 75 Ma. Output Current.	Condenser Input to Filter.									
117Z6GT	T-9	Duodiode	7Q	117	0.075	Voltage Dblr.	117 A.C. Volts Per Plate, RMS, 60 Ma. Output Current.										
407A GB-407A (3)	T-6½	Duotriode	407A	40 20	0.050 0.100	Amplifier	1.35	150	240 [■]	8.2	6370	5500	
408A GB-408A (3)	T-5½	Pentode	7BD	20	0.050	Amplifier	1.7	120	200 [■]	120	7.0	2.2	340000	5000	
417A	T-6½	Triode	9V	6.3	0.300	UHF R-F Amp.	4.0	Characteristics Same as Type 5842.										
807 807W (3)	ST-16 ST-12	Beam Pent.	5AW	6.3	0.900	P.P.AB1 Amp. P.P.AB2 Amp. P.P.AB2 Amp.	25	400 400 600	45 25 30 300 300	60-140† 90-240† 60-200† 2.15† 0.7-16†	(Current, Output for 2 Tubes) (Current, Output for 2 Tubes) (Current, Output for 2 Tubes)	3000 3200 6400	15000 55000 80000			
884	ST-12	Gas Triode	6Q	6.3	0.600	Relay Tube	300	30	75	For Relay Operation Limit Time to 30 Secs. 300 Ma. Pa Current. 16 Volt Tube Drop.				
FM1000	Lock-in	Heptode	FM 1000	6.3	0.300	F-M Det.	
1216 (3) GB-1216 (3)	T-5½	Duotriode	7BF	6.3	0.300	Computer	0.55	100 150 150	470 [■] 0 10	4.8 4.8 Min. 0.1 Max. Plate Res. = 20K Ohms. Plate Res. = 20K Ohms.	7950 3400	27 Grid Res. = 47K Ohms. Grid Res. = 47K Ohms.		
1217 (3) GB-1217 (3)	T-5½	Heptode	7CH	6.3	0.300	Dual-Control Computer	1.0	67.5 67.5 150	0 4 0	67.5 67.5 75	Grid No. 3 = 0 Volts Grid No. 3 = 0 Volts 5.8	2400 1700 9 Rb = 20K, RG3 = 47K, RG1 = 47K, RG2-4 = 470 Ohms			
1221	ST-12	Pentode	6F	6.3	0.300	Amplifier	.825	Special Non-Microphonic Tube, Characteristics Same as Type 6C6.										
1222A	ST-14	Beam Pent.	1222	6.3	0.900	Power Amp.	20.9	Characteristics Similar to Type 6L6GA.										
1223	ST-12	Pentode	7R	6.3	0.300	Amplifier	.825	"G" Equivalent of Type 1221 Above.										
1229	ST-12	Tetrode	4K	2.0†	0.060		Special Type 32. Made for Low Grid Current Application.										

(1) See Frontal Section. (2) Design Maximum Values. † Maximum Signal. (3) Has Special Mechanical and/or Life Characteristics. (4) Average Contact Potential Bias Developed Across Specified Grid Resistor. ‡ Filamentary Type. * Controlled Heater Warm-up Time (applies to parallel connections of types having a tapped heater.) †† Plate to Plate. ††† Cathode Resistor (ohms).

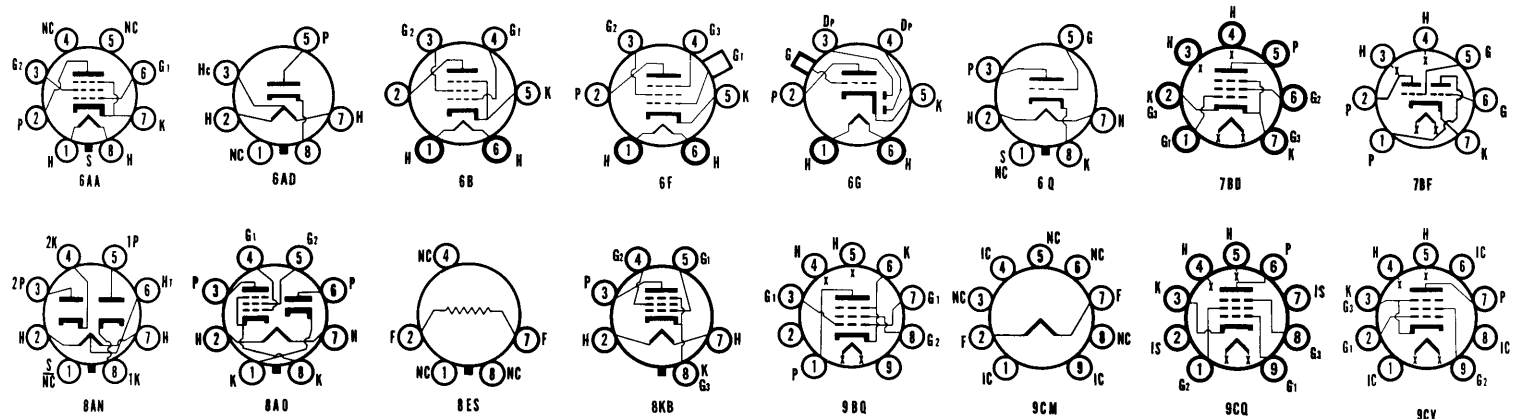

SYLVANIA TUBES

TYPE	CONSTRUCTION			EMITTER		USE	Plate Diss. Watts ²	Plate Volts	Negative Grid Volts	Screen Volts	Plate Current Ma.	Screen Current Ma.	Plate Resis. Ohms	Transconductance Micros.	Amplification Factor	Ohms Load for Stated Power Output	Power Output Milli-watts		
	Bulb Size or Style ¹	Class	Basing Diag.	Volts	Amps.														
1230	T-9	Triode	4D	2.0♣	0.060		Special Type 30.	Made for Low Grid Current Applications.										
1231	Lock-in	Pentode	8V	6.3	0.450	R-F Amp. Tet. Amp.	300	200♣	150	10.0	2.5	700000	5500	3850		
1232	Now Known as Type 7G7.							300	200♣	150	12.0	0.5	540000	6500	3500		
1236A	T-9	Diode	1236A	1.9♣	0.450	Regulator	Plate Voltage = 330 Volts (Abs. Max.). D.C. Current = 0.8 Ma. (Abs. Max.). Plate Current = 0.63 Ma. Plate Load Resistance = 0.25 Meg.											
1238	Lock-in	Duo. Beam Amplifier	8BS	28.0	0.400	Amplifier	3.3	Characteristics Similar to 28D7.											
1247	T-3	Diode	1247	0.7♣	0.065	R-F Probe	300 A.C. Volts RMS, 0.4 Ma. D.C. Plate Current.											
1265	ST-12	Diode	4AJ	Voltage Reg.	Starting Voltage = 135, Operating Voltage = 90, Operating Current = 5 to 30 Ma.											
1266	T-9	Diode	4AJ	Regulator	Voltage Regulator Similar to Type OB3/VR-90-30, Except Regulating at 70 Volts.											
1267	T-9	Gas Triode	4V	Relay Tube	Similar to Type OA4G.											
1273	Lock-in	Pentode	8V	6.3	0.300	Amplifier	1.1	Characteristics Same as Type 7C7 (Special Non-Microphonic Tube).											
1274	T-9	Duodiode	6S	6.3	0.600	F-W Rect.	Characteristics Same as Type 7Y4.											
1275	ST-16	Duodiode	4C	5.0♣	1.750	F-W Rect.	Similar to Type 5Z3.											
1276	ST-16	Triode	4D	4.5♣	1.140	Power Amp.	16.5	Similar to Type 6A3.											
1280	Lock-in	Pentode	8V	12.6	0.150	Amplifier	1.1	Characteristics Same as Type 14C7 (Special Non-Microphonic Tube).											
1284	Lock-in	Pentode	8V	12.6	0.150	R-F Amp.	250	3	100	9.0	2.5	800000	200			
1291	Now Known as Type 3B7.																		
1293	Lock-in	Triode	4AA	1.4♣	0.110	Oscillator	90	0	5.2	1500	15		
1294	Now Known as Type 1R4							90	20	13.25	120 Mc. Oscillator Rg = 10000 Ohms.					
1299	Now Known as Type 3D6.																		
1612	Metal	Heptode	7T	6.3	0.300	Mixer Amp.	1.65	Characteristics Same as Type 6L7.											
1614	T-10 Sp.	Beam Pent.	7S	6.3	0.900	P.P.AB1 Amp.	21	360	22.5	270	88-132†	15†	6600	26500		
								530	36	340	60-160†	20†	7200	50000		
1625	ST-16	Beam Pent.	5AZ	12.6	0.450	P.P.AB1 Amp. P.P.AB2 Amp.	25	Characteristics Same as Type 807.											
2050	ST-12	Gas Tetrode	6BS	6.3	0.600	Relay Tube	400	5.0	0	100	For Relay Operation Limit Time to 30 Seconds. 1 Amp. Peak Current, 8 Volts Tube Drop.						
2050A							220	4.0	0	75		
5636 (3)	T-3	Pentode	8DC	6.3	0.150	Mixer	1.1	100	150♣	100	3.6	5.3	320000	1280*		
5639 (3)	T-3	Beam Pent.	8DL	6.3	0.450	Power Amp.	4.0	150	100♣	100	21	4	50000	9000	1000		
5641 (3)	T-3	Diode	6CJ	6.3	0.450	H-W Rect.	117 A.C. Volts Per Plate, RMS, 48 Ma. D.C. Output. Condenser Input to Filter. 235 A.C. Volts Per Plate, RMS, 45 Ma. D.C. Output. Condenser Input to Filter.											
5642	T-3	Diode	5642	1.25♣	0.200	H-W Rect.	Pulse Type Rectifier for Television Service, 10000 Volts Peak Inverse.											
5643 (3)	T-3	Gas Tetrode	8DD	6.3	0.15	Relay Tube	150	5 A.C.	0	16	(Grid Bias Voltage 180°, Out of Phase with Anode Voltage.)						
5644 (3)	T-3	Gas Diode	4CN	Voltage Reg.	Starting Voltage at 130, Operating Voltage 95, Operating Current 5 to 25 Ma.											
5647 (3)	T-1	Diode	5647	6.3	0.150	Detector	117 Volts, RMS Plate, 9 Ma. D.C. Output.											
5651	T-5½	Gas Diode	5BO	Volt. Ref.	Starting Voltage = 115 Volts Max. Operating Voltage = 92 Volts Max. Operating Current = 3.5 Ma. Max.											
5651WA (3)																			
5654/6AK5W(3)	T-5½	Pentode	7BD	6.3	0.175	VHF Amp.	1.65	120	200♣	120	7.5	2.5	340000	5000		
5654/6AK5W/6096																			
GB-5654(3)																			
5670(3)	T-6½	Duotriode	8CJ	6.3	0.350	VHF Amp.	1.35	150	240♣	8.2	6370	5500	35		
GB-5670(3)																			
5670WA(3)																			
5686	T-6½	Beam Pent.	9G	6.3	0.350	Power Amp.	8.25	250	12.5	250	27	5.0	3100	9000	2700		
5687 (3)	T-6½	Duotriode	9H	6.3	0.900	Amplifier	4.2	250	12.5	12	3000	5400	16		
GB-5687 (3)				12.6	0.450			180	7.0	23	2000	8500	17		

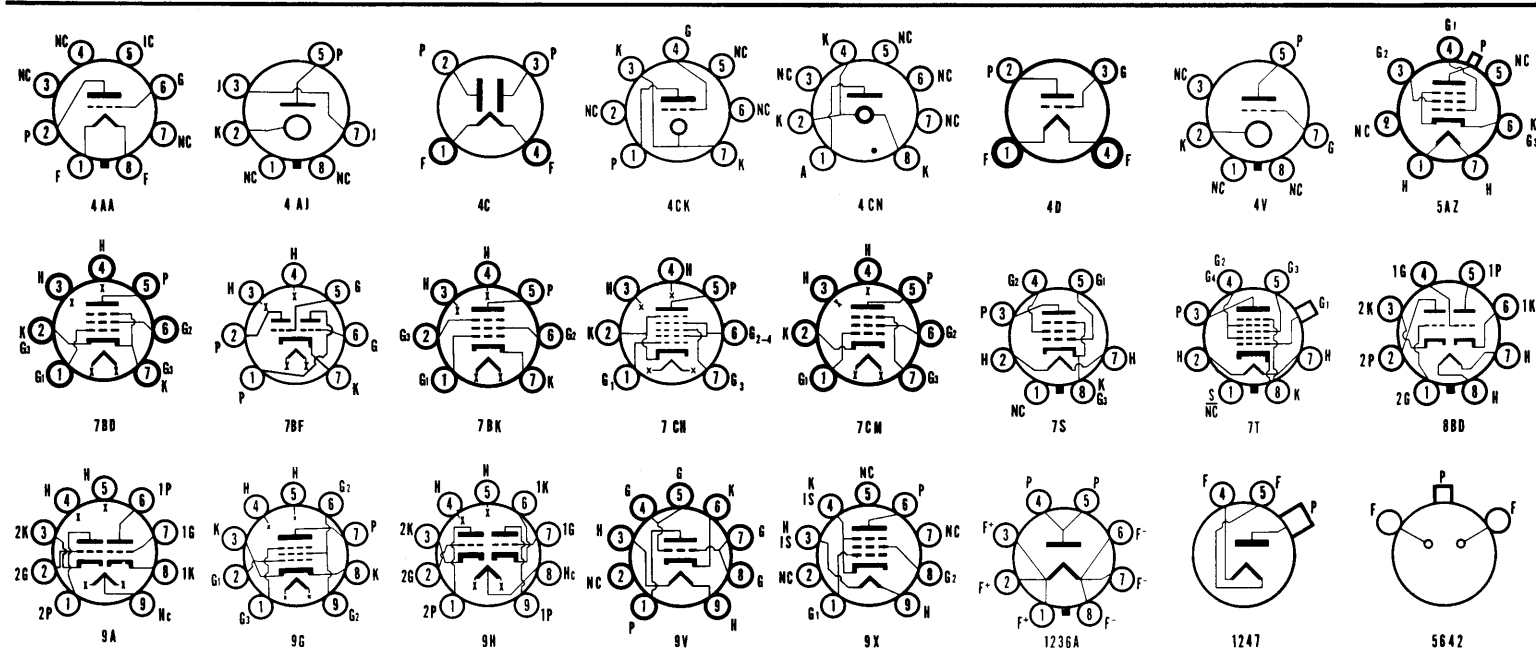

AVERAGE CHARACTERISTICS

TYPE	CONSTRUCTION			EMITTER		USE	Plate Diss. Watts ²	Plate Volts	Negative Grid Volts	Screen Volts	Plate Current Ma.	Screen Current Ma.	Plate Resis. Ohms	Transcon-ductance Micros.	Ampli-fication Factor	Ohms Load for Stated Power Output	Power Output Milli-watts
	Bulb Size or Style ¹	Class	Basing Diag.	Volts	Amps.												
5691	T-9	Duotriode	8BD	6.3	0.600	A-F Amp.	1.0	250	2	2.3	44000	1600	70
5692	T-9	Duotriode	8BD	6.3	0.600	A-F Amp.	1.75	250	9	6.5	9100	2200	20
5693	Metal	Pentode	8N	6.3	0.300	A-F Amp.	2.0	250	3	100	3.0	0.85	1650
5702 5702WA (3) 5702WB (3)	T-3	Pentode	5702	6.3	0.200	VHF Amp.	120	200 [■]	120	7.5	2.5	340000	5000
5703 5703WA (3) 5703WB (3)	T-3	Triode	5703	6.3	0.200	VHF Osc.	3.3	120	220 [■]	9.0	5000	25
5704 (3)	T-2	Diode	5704	6.3	0.150	VHF Det.	3.3	150 Volts, RMS Plate, 9 Ma. D.C. Output Current.									
5718 (3)	T-3	Triode	8DK	6.3	0.150	UHF Amp.	3.3	100	150 [■]	8.5	4650	5800	27
								150	180 [■]	13.0	4150	6500	27
5719 (3)	T-3	Triode	8DK	6.3	0.150	UHF Amp.	.055	150	680 [■]	1.85	30500	2300	70
5722 (3)	T-5½	Diode	5CB	4.9 [†]	1.600	Noise Diode	200	For Noise Generator Service Ib 35 Ma. Max.								
5725 (3) GB-5725 (3) 5725/6AS6W(3)	T-5½	Pentode	7CM	6.3	0.175	Mixer	1.65	120	2	120	5.2	3.5	3200
5726/6AL5W(3) GB-5726 (3) 5726/6AL5W/6097(3)	T-5½	Duodiode	6BT	6.3	0.300	Rectifier	117 Volts, RMS Plate, 9 Ma. D.C. Output Current Per Plate.									
5744	T-3	Triode	5744	6.3	0.200	A-F Amp.	250	500 [■]	4	4000	70
5749/6BA6W(3) GB-5749	T-5½	Pentode	7BK	6.3	0.300	R-F Amp.	3.3	100	68 [■]	100	10.8	4.4	250000	4300
								250	68 [■]	100	11.0	4.2	1.0 Meg.	4400
5750 (3) 5750/6BE6W(3) GB-5750 (3)	T-5½	Heptode	7CH	6.3	0.300	Converter	1.1	Characteristics Same as Type 6BE6.									
5751WA (3) 5751 (3) GB-5751 (3)	T-6½	Duotriode	9A	6.3 12.6	0.350 0.175	A-F Amp.	0.8	Characteristics Same as Type 12AX7.									
5783	T-3	Gas Diode	5783	Voltage Reg.	Starting Voltage at 115 Volts. Operating Voltage 85. Operating Current 1.5 to 3.5 Ma.									
5784	T-3	Pentode	5784	6.3	0.200	Amplifier	1.87	120	2	120	5.2	3.5	3200
5785	T2x3	Diode	5785	1.25 [†]	0.015	H-W Rect.	1235 Volts, RMS Plate, 100 μa D.C. Output Current.									
5787	T-3	Gas Diode	5783	Voltage Reg.	Starting Voltage at 135 Volts. Operating Voltage 100. Operating Current 5 to 25 Ma.									
5814 (3) GB-5814A (3) 5814WA (3)	T-6½	Duotriode	9A	6.3/ 12.6	0.350/ 0.175	Class A Amplifier	3.0	100	0	11.8	6250	3100	19.5
								250	8.5	10.5	7700	2200	17.0
5823	T-5½	Gas Triode	4CK	Relay Tube	Peak Cathode Ma. = 100 Max. D.C. Cathode Ma. = 25 Max. Starter Anode Volt Drop = 61 Volts. Anode Drop = 62 Volts.									
5824 (3)	ST-14	Beam Pent.	7S	25.0	0.300	Power Amp.	13.7	135	22	135	61	2.5	15000	5000	1700	4300
5840 (3)	T-3	Pentode	8DL	6.3	0.150	R-F Amp.	1.1	100	150 [■]	100	7.5	2.4	260000	5000
5842 (3)	T-6½	Triode	9V	6.3	0.300	UHF R-F Amplifier	4.0	150	62 [■]	26	1800	24000	43
5844 (3) GB-5844 (3)	T-5½	Duotriode	7BF	6.3	0.300	Computer	1.0	100	470 [■]	4.8	7550	3700	28
5845	T-5½	Duodiode	5CA	5.0 [†]	0.435	Control Diode	300max.	2.0max.
5847 (3)	T-6½	Pentode	9X	6.3	0.300	R-F Amp.	3.3	150	110 [■]	150	13	4.5	12500
5851	T-3	Pentode	6CL	1.25 [†] 2.50 [†]	0.110 0.055	R-F Amp.	1.65	125	7.5	125	5.5	0.9	175000	1600	650
5871	T-9	Beam Pent.	7S	6.3	0.450	Power Amp.	13.2	Characteristics Same as Type 6V6GT.									

- (1) See Frontal Section. (3) Has Special Mechanical and/or Life Characteristics. * Controlled Heater Warm-up Time (applies to parallel connections of types having a tapped heater.)
 (2) Design Maximum Values. (4) Average Contact Potential Bias Developed Across Specified Grid Resistor. † Maximum Signal. ‡ Filamentary Type. ▲ Conversion Transconductance. ¶ Plate to Plate. ■ Cathode Resistor (ohms).

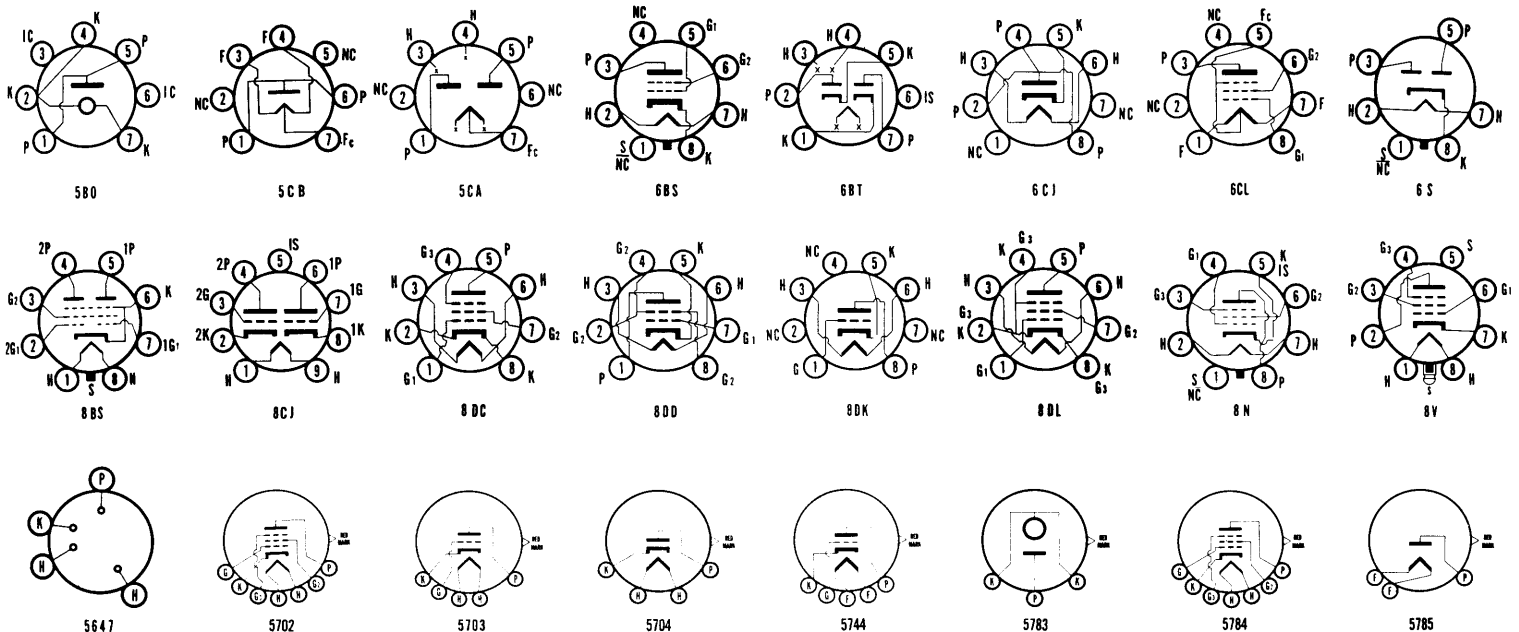

SYLVANIA TUBES

TYPE	CONSTRUCTION			EMITTER		USE	Plate Diss. Watts ²	Plate Volts	Negative Grid Volts	Screen Volts	Plate Current Ma.	Screen Current Ma.	Plate Resis. Ohms	Transconductance Micros.	Amplification Factor	Ohms Load for Stated Power Output	Power Output Milli-watts
	Bulb Size or Style ¹	Class	Basing Diag.	Volts	Amps.												
5879	T-6½	Pentode	9AD	6.3	0.150	A-F Amp.	1.37	250	3	100	1.8	0.4	2000000	1000	21
5881	T-11	Beam Pent.	7S	6.3	0.900	Power Amp.	25.3	Characteristics Same as Type 6L6G.									
5889	T-3	Pentode	5889	1.25	7.5 Ma	Amplifier	12	2.0005	.005	1.8 Meg.	(For Low Grid Current Applications.)			
5896 (3)	T-3	Duodiode	8DJ	6.3	0.300	F-W Rect.	150 Volts, RMS Per Plate, 18 Ma. D.C. Output Current.									
5899 (3)	T-3	Pentode	8DL	6.3	0.150	R-F Amp.	1.1	100	120	100	7.2	2.2	260000	4500
5902 (3)	T-3	Pentode	8DL	6.3	0.450	Power Amp.	4.0	110	270	110	30	2.2	15000	4200	1000
5903 (3)	T-3	Duodiode	8DJ	26.5	0.075	UHF Det.	PIV = 460 Volts, PKIb = 60 Ma., Ib = 10 Ma. and EHK = 360 Volts.									
5904 (3)	T-3	Triode	8DK	26.5	0.045	UHF Osc./Amp.	26.5	2.2 Meg ⁴	3.0	4000	5000	20
5905 (3)	T-3	Pentode	8DL	26.5	0.045	UHF Amp.	26.5	2.2 Meg ⁴	26.5	2.1	0.75	150000	2850
5906 (3)	T-3	Pentode	8DL	26.5	0.045	UHF Amp.	1.1	100	150	100	7.5	2.4	260000	5000
5907 (3)	T-3	Pentode	8DL	26.5	0.045	UHF Amp.	26.5	2.2 Meg ⁴	26.5	2.7	1.1	100000	3000
5908 (3)	T-3	Pentode	8DC	26.5	0.045	UHF Amp.	26.5	2.2 Meg ⁴	26.5	3.3	2.0	31000	2200
5910 (3)	T-5½	Pentode	6AR	1.4	0.050	R-F Amp.	90	0	90	1.6	0.45	1500000	900
5915 (3)	T-5½	Dual Control Heptode	7CH	6.3	0.300	Computer	1.0	150	0	75	5.8	9.0	Grid No. 3 Voltage = 0 Rb = 20K Ohms				
5915A (3)							150	10.0	75	0	0	Grid No. 3 Voltage = 0					
GB-5915A (3)							150	0	75	0	14.0	Grid No. 3 Voltage = -10					
5916 (3)	T-3	Pentode	8DC	26.5	0.045	Dual-Control Mixer	1.1	100	150	100	5.3	3.6	110000	3200
5931 (3)	T-12	Duodiode	5T	5.0	3.000	F-W Rect.	Characteristics Same as Type 5U4G.										
GB-5931 (3)																	
5932 (3)	T-12	Beam Pent.	7S	6.3	0.900	Power Amp.	Characteristics Same as Type 6L6G.										
GB-5932 (3)																	
5933 (3)	T-12	Beam Pent.	5AW	6.3	0.900	Power Amp.	Characteristics Same as Type 807W.										
5933WA (3)																	
5933 (3)																	
5963 (3)	T-6½	Duotriode	9A	6.3	0.300	Computer	2.5	67.5	0	8.5	6600	3200	21
GB-5963 (3)				12.6	0.150		150	0	5.4	(Rb = 20000 Ohms)			
5964 (3)	T-5½	Duotriode	7BF	6.3	0.450	Computer	1.5	100	50	9.5	6500	6000	39
GB-5964 (3)							150	0	5.0	(Rb = 20000 Ohms)			
5965A	T-6½	Duotriode	9A	6.3/	0.450/	Computer	2.4	150	220	8.5	7000	6700	47
GB-5965 (3)				12.6	0.225							
5968	T-3	Duotriode	8DQ	1.25	0.120	VHF Mixer	45	0	0.7	1300	50
5969	T-3	Duotetrode	8DR	1.25	0.200	VHF Amp. or VHF Osc.	0.96	135	3.0	45	6.0	0.6	1700
							Class A Ratings										
5970	T-3	Duo. Pentode	8DS	1.25	0.160	VHF Amp.	45	5 Meg. ⁴	45	3.0	0.9	170000	1850
5977 (3)	T-3	Triode	8DK	6.3	0.150	Amplifier	3.3	100	270	10.0	3650	4500	16
5987 (3)	T-3	Triode	8DM	6.3	0.450	Amplifier	4.0	100	18	9.0	1850	4.1
5998A	T-12	Duotriode	8BD	6.3	2.400	Passing Tube for V.R. Serv.	15	110	105	100	350	15500	5.4
6000	T-11	Beam Pent.	6CK	26.5	0.280	Class "C" Amp./Osc.	25	400	60	200	125	16	RG = 12000 Ohms, PK R-F = 75 V, IG1 = 5 Ma, Driving Power = 0.4 Watt,				28
							600	60	225	100	18	RG = 20K Ohms, PK. R-F = 75 V, IG1 = 3 Ma., Driving Pwr. = 0.23 Watts				
6005 (3)	T-5½	Beam Pent.	7BZ	6.3	0.450	S.T. Class A1	11	180	8.5	180	29.	3.0	58000	3700	5500	2000
GB-6005 (3)							250	12.5	250	45.	4.5	52000	4100	5000	4500
6005/6A05W/6095(3)							250	15	250	70-79†	5-13†	Current, Output for 2 Tubes				10000†
6005/6A05W (3)																	
6021 (3A)	T-3	Duotriode	8DG	6.3	0.300	UHF Amp.	1.1	100	150	6.5	6480	5400	35
6028	T-5½	Pentode	7BD	20	0.050	Amplifier	1.87	120	180	120	7.5	2.5	300000	5000
GB-6080	T-12	Duotriode	8BD	6.3	2.500	Passing Tube for V.R. Service	13	135	250	200	280	7000	2
6080													
6082A	T-12	Duo Power Triode	8BD	26.5	0.600	Power Amp.	13	135	250	125	280	7000	2

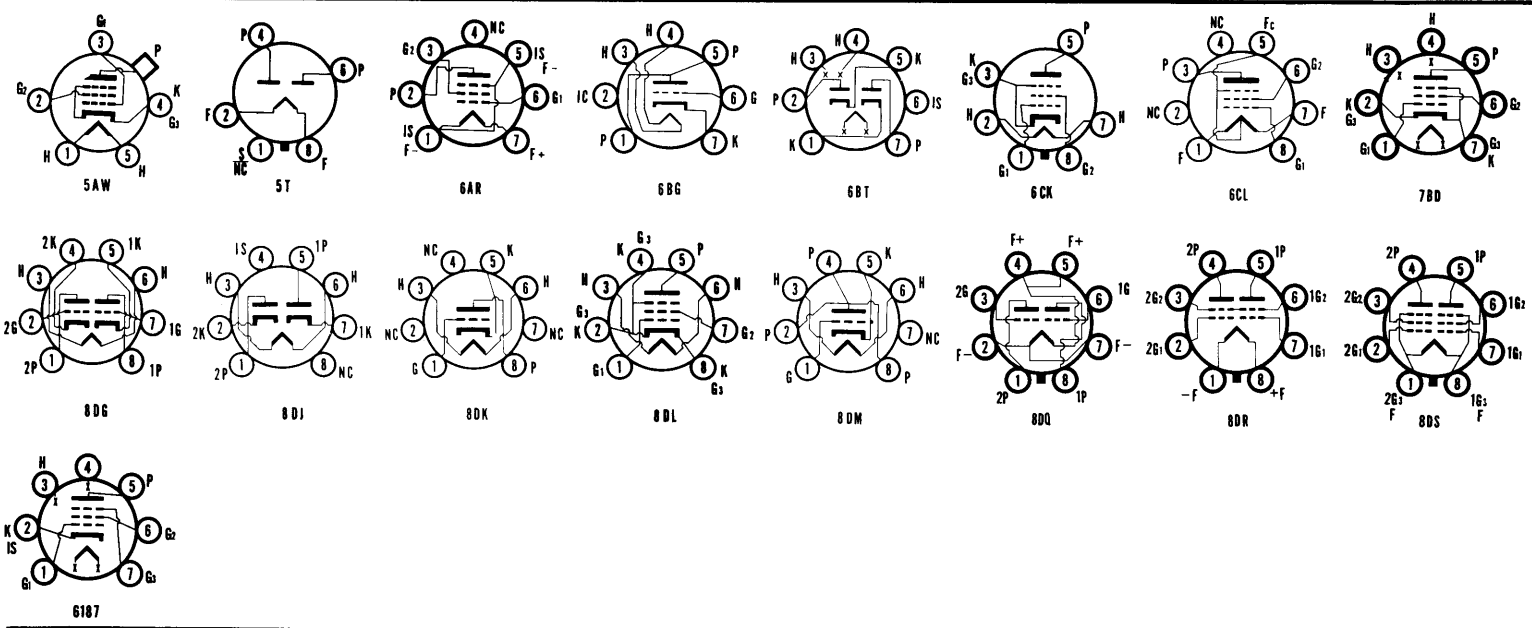

AVERAGE CHARACTERISTICS

TYPE	CONSTRUCTION			EMITTER		USE	Plate Diss. Watts ²	Plate Volts	Negative Grid Volts	Screen Volts	Plate Current Ma.	Screen Current Ma.	Plate Resis. Ohms	Transconductance Micros.	Amplification Factor	Ohms Load for Stated Power Output	Power Output Milli-watts
	Bulb Size or Style ¹	Class	Basing Diag.	Volts	Amps.												
6095 (3)	T-5½	Beam Pent.	7BZ	6.3	0.450	Power Amp.	13.2	Characteristics Same as Type 6AQ5.									
6096 (3)	T-5½	Beam Pent.	7BZ	6.3	0.450	Power Amp.	13.2	Characteristics Same as Type 6AQ5.									
6097	T-5½	Duodiode	6BT	6.3	0.300	F-W Rect.	Characteristics Same as Type 5726/6AL5W.									
6098 (3)	T-12	Beam Tet.	6098	6.3	1.200	Oscilloscope Defl. Amp.	21.0	Characteristics Same as Type 6AR6.									
6099 (3)	T-5½	Duotriode	7BF	6.3	0.450	VHF Osc. VHF Amp.	1.6	Characteristics Same as Type 6101 Except Plate Current Difference Between Units Shall Not Exceed 0.25 Ma. Initially or 1.0 Ma. After 500 Hours.									
6100 (3)	T-5½	Triode	6BG	6.3	0.150	R-F Osc. R-F Amp.	5.5 3.85	Characteristics Same as Type 6C4.									
6101 (3) GB-6101	T-5½	Duotriode	7BF	6.3	0.450	VHF Osc./ Amp.	1.6	Characteristics Same as Type 6J6.									
6110 (3)	T-3	Duodiode	8DJ	6.3	0.150	UHF Det.	Peak Inverse Voltage = 460 Volts. Peak Anode Current = 26.4 Ma. Per Plate.									
6111 (3)	T-3	Duotriode	8DG	6.3	0.300	Med. Mu Amplifier	1.1	100	220 [■]	8.5	4200	4750	20
6112 (3)	T-3	Duotriode	8DG	6.3	0.300	High Mu Amplifier	0.55	100 150	1500 [■] 820 [■]	0.8 1.75	38900 28000	1800 2500	70 70
6118 (3)	Metal	Duodiode Tri.	7V	6.3	0.300	Det. Amp.	100 250	1.0 3.0	0.8 1.0	58000 58000	1200 1200	70 70
6135 (3) GB-6135 (3)	T-5½	Triode	6BG	6.3	0.170	VHF Osc./ Amp.	3.8	Characteristics Same as Type 6C4.									
6136 (3)	T-5½	Triode	6BG	6.3	0.175	VHF Osc.	3.5	250	8.5	10.5	7700	2200	17
6145 GB-6145 (3)	Lock-in	Pentode	8V	6.3	0.600	Computer	11	150	0	100	34	8.0	0.1 Meg.	9700
6146	T-12	Beam Pent.	7CK	6.3	1.250	P.P.AB1 Amp. P.P.AB1 Amp. P.P.AB2 Amp.	20	600 500 600	45 44 44	180 175 165	26-200† 27-242† 22-207†	1-23† 0.7-18† 0.6-17†	(Current, Output for 2 Tubes) (Current, Output for 2 Tubes)		7000† 4600† 6800†	82000 83000 90000	
6147	T-3	Power Pent.	6CL	1.25♦	0.125	VHF Power Amplifier	1.5	125	7.5	125	5.5	0.9	175000	1600
6186 (3) 6186 6186/6AG5WA(3) GB-6186 (3)	T-5½	Pentode	7BD	6.3	0.300	VHF Amp.	2.5	250	200 [■]	150	7	2	5000
6187	T-5½	Pentode	6187	6.3	0.175	VHF Amp.	1.6	120	2.0	120	5.2	3.5	3200
6188	T-9	Duotriode	8BD	6.3	0.300	D.C. Amp.	1.1	250	2.0	2.3	44000	1600	70
6189 (3) 6189/12AU7WA(3) GB-6189 (3)	T-6½	Duotriode	9A	6.3 12.6	0.300 0.150	Osc./Amp.	3.0	Characteristics Same as Type 12AU7.									
6201 (3) GB-6201 (3)	T-6½	Duotriode	9A	6.3 12.6	0.300 0.150	VHF Amp.	2.5	Characteristics Same as Type 12AT7.									
6205 (3)	T-3	Pentode	8DC	6.3	0.150	UHF Amp.	1.1	100	150 [■]	100	7.5	2.4	0.26 Meg.	5000
6206 (3)	T-3	Pentode	8DC	6.3	0.150	UHF Amp.	1.1	100	120 [■]	100	7.5	2.0	0.26 Meg.	4500
6211A	T-6½	Duotriode	9A	12.6/ 6.3	0.150/ 0.300	Computer	1.3	100	2.0	6.6	6500	4700	31
6308 (3)	T-3	Gas Diode	8EX	Voltage Reg.	Starting Voltage at 115 Volts. Operating Voltage at 87 Volts and Current at 3.5 Ma. Max.									
6336A	TT-16	Duo Power Triode	8BD	6.3	5.000	Passing Tube for V.R. Serv.	30	190 200 [■]	182	300	13500	2.7
6350 (3) GB-6350 (3)	T-6½	Duotriode	9CZ	6.3 12.6	0.600 0.300	Computer	3.85	150	5.0	11.0	3900	4600	18
6352 (3)	T-3	Duodiode	8EY	3.0♦ Series	0.360 Series	Regulator	Temperature Limited Diode. Max. Ef. = 4.0. Max. Eb. = 275. Max. Ib. = 1.1 Ma.									

(1) See Frontal Section.
(2) Design Maximum Values.
† Maximum Signal.

(3) Has Special Mechanical and/or Life Characteristics.
(4) Average Contact Potential Bias Developed Across Specified Grid Resistor.
♦ Filamentary Type. ▲ Conversion Transconductance.

* Controlled Heater Warm-up Time (applies to parallel connections of types having a tapped heater.)
‡ Plate to Plate. ■ Cathode Resistor (ohms).

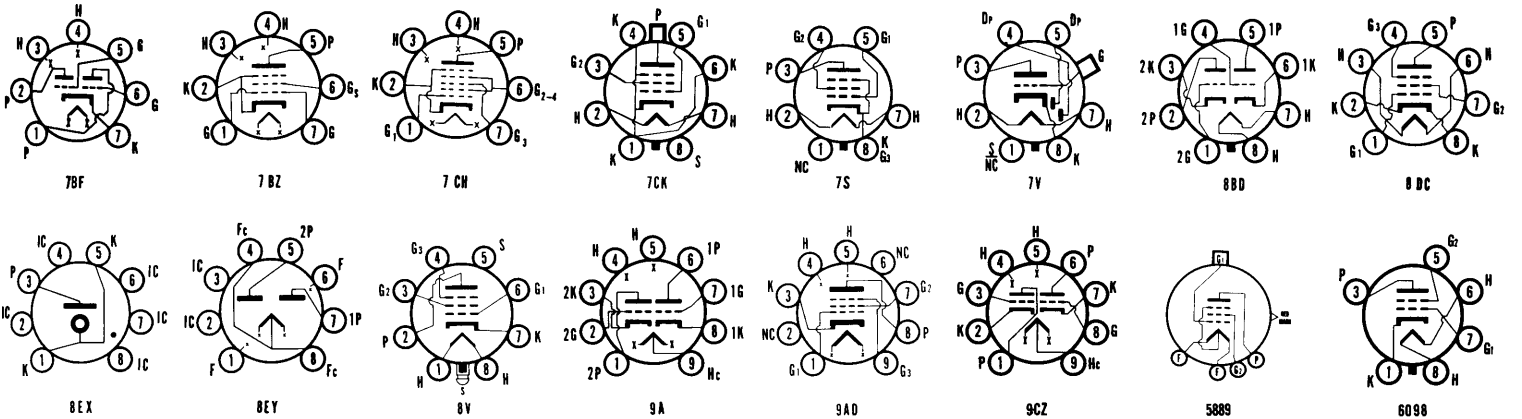

SYLVANIA TUBES

TYPE	CONSTRUCTION			EMITTER		USE	Plate Diss. Watts ²	Plate Volts	Negative Grid Volts	Screen Volts	Plate Current Ma.	Screen Current Ma.	Plate Resis. Ohms	Transcon-ductance Micros.	Ampli-fication Factor	Ohms Load for Stated Power Output	Power Output Milli-watts
	Bulb Size or Style ¹	Class	Basing Diag.	Volts	Amps.												
6354	T-5½	Diode	7DU	Voltage Reg.	Starting Voltage at 180. Operating Volts 150. Operating Current 5 Ma. Min., 30 Ma. Max.									
6394A	TT-16	Duo Power Triode	8BD	26.5	1.300	Passing Tube for V.R. Serv.	30	Characteristics Same as Type 6336A.									
6418	T-2	Pentode	6418	1.25	0.010	Power Amp.	22.5	1.2	22.5	.24	.60	420000	300	100000	2200
6463	T-6½	Duotriode	9CZ	6.3 12.6	0.600 0.300	Computer	4.4	200 250	11.0 620	1.0 14.5	3850	5200	20
6483	T-3	Gas Tetrode	6483	Switching	450	Trigger Grid Voltage = 0 Volts. Trigger Pulse Voltage = 300 Volts. Keep Alive Current = 45 µa.								
6486A	T-6½	Pentode	9DV	6.3	0.250	Dual Control Pentode	2.0	120	2	120	3.5	3.3	3250
6516	T-5½	Beam Pent.	6CH	6.3	0.200	VHF/AF Power Amp.	5.2	250	13.5	250	16.0	2.25	150000	2550	16000	1400
6520	T-16	Duo Power Triode	8BD	6.3	2.500	Passing Tube for V.R. Serv.	15.4	Characteristics Same as Type 6AS7G.									
6528	ST-16	Duo Power Triode	8BD	6.3	5.000	Passing Tube for V.R. Serv.	30	100	4	185	245	37000	9
6550	ST-16	Beam Pent.	7AC	6.3	1.800	S.T. A1 Amp. P.P.AB1 Amp.	42.0	400 600	23 32.5	270 300	170-225† 100-270†	9-35† 5-33†	15000 (Current, Output for 2 Tubes)	11000	3500 5000†	60000 100000
6582A	T-6½	Pentode	9EJ	6.3	0.250	R-F Pent.	2.0	120	2	120	7.5	2.5	.5 Meg.	4500
6611	T-2x3	Pentode	6611	1.25	0.020	VHF Amp.	0.1	30 45	5 Meg. ⁴ 5 Meg. ⁴	30 45	1.0 1.0	0.35 0.35	400000 400000	1000 1000
6612	T-2x3	Pentode	6612	1.25	0.080	VHF Amp.	0.2	30 45	2 Meg. ⁴ 2 Meg. ⁴	30 45	3.0 3.0	1.0 1.0	180000 180000	3000 3000
6626	T-5½	Gas Diode	5BO	Voltage Reg.	Starting Voltage = 165. Operating Voltage = 148. Operating Current = 5 to 30 Ma.									
6627	T-5½	Gas Diode	5BO	Voltage Reg.	Starting Voltage = 130. Operating Voltage = 108. Operating Current = 5 to 30 Ma.									
6660/6BA6	T-5½	Pentode	7BK	6.3	0.300	R-F/I-F Amp.	3.3	100 250	68 [■] 68 [■]	100 100	10.8 11	4.4 4.2	250000 1 Meg.	4300 4200
6661/6BH6	T-5½	Pentode	7CM	6.3	0.150	R-F/I-F Amp.	3.3	100 250	200 [■] 95 [■]	100 100	3.6 7.4	1.4 2.9	700000 1.4 Meg.	3400 4600
6662/6BJ6	T-5½	Pentode	7CM	6.3	0.150	R-F/I-F Amp.	3.3	100 250	80 [■] 80 [■]	100 100	9 9.2	3.5 3.3	250000 1.3 Meg.	3650 3600
6663/6AL5	T-5½	Duodiode	6BT	6.3	0.300	Detector	A.C. Voltage Per Plate = 117 Volts. D.C. Output Current = 9.0 Ma.									
6664	T-5½	Triode	5CE	6.3	0.150	VHF Amp./Osc.	2.9	Characteristics Same as Type 6AB4.									
6669/6AQ5	T-5½	Beam Pent.	7BZ	6.3	0.450	A-F Pwr. Amp.	12	250	12.5	250	45	4.5	52000	4100	5000	4500
6676	T-5½	Pentode	7CM	6.3	0.300	VHF Amp.	2.3	Characteristics Same as Type 6CB6.									
6677/6CL6	T-6½	Beam Pent.	9BV	6.3	0.650	R-F Osc./Amp.	8.5	250	3.0	150	30	7	150000	11000	7500	2800
6678/6U8	T-6½	Tri. Pentode	9AE	6.3	0.450	VHF Osc./Amp.	3.0 3.0	150 250	56 [■] 68 [■] 110	18 10 3.5	5000 400000	8500 5200	40
6679/12AT7	T-6½	Duotriode	9A	6.3/ 12.6	0.300/ 0.150	VHF Osc./Amp.	2.8	100 250	270 [■] 270 [■]	3.7 10	15000 10900	4000 5500	60
6680/12AU7	T-6½	Duotriode	9A	6.3/ 12.6	0.300/ 0.150	Gen. Purpose	3.0	100 250	0 8.5	11.8 10.5	6500 7700	3100 2200	20 17
6681/12AX7	T-6½	Duotriode	9A	6.3/ 12.6	0.300/ 0.150	A-F Amp.	1.1	100 250	1.0 2.0	0.5 1.2	80000 62500	1250 1600	100 100
6690 (3)	T-3	Duotriode	8GQ	6.3	0.300	Video Amp.	1.1	100	100 [■]	8.0	4800	35
6788 (3)	T-3	Pentode	8DL	6.3	0.175	Audio Amp.	0.5	100	1500 [■]	100	0.7	0.1	1.2 Meg.	1100
GB-6814 (3)	T-3	Triode	8DK	6.3	0.150	Computer	2.2	100	0	10	4800	6000	29
6832	T-3	Duotriode	8DG	6.3	0.400	D.C. Amp.	0.1	100	3000 [■]	0.8	1050
6840	T-6½	Duotriode	9CZ	12.6 6.3	0.400 0.800	Computer	4.0	250	620 [■]	14	3400	7100	20
6851	T-6½	Duotriode	9A	6.3	0.250	Amplifier	1.0	250	3100 [■]	1.0	60000	1200	70

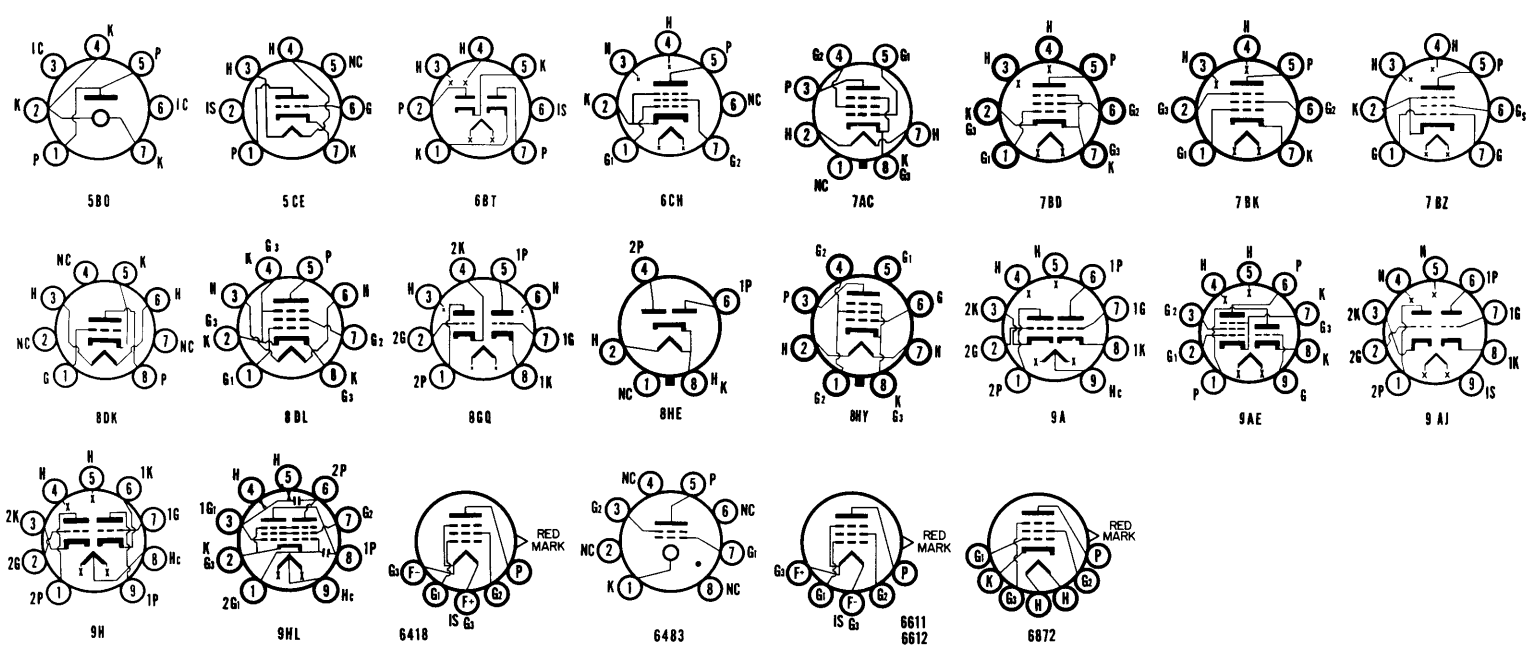

AVERAGE CHARACTERISTICS

TYPE	CONSTRUCTION			EMITTER		USE	Plate Diss. Watts ²	Plate Volts	Negative Grid Volts	Screen Volts	Plate Current Ma.	Screen Current Ma.	Plate Resis. Ohms	Trans-conductance Micros.	Amplification Factor	Ohms Load for Stated Power Output	Power Output Milli-watts		
	Bulb Size or Style ¹	Class	Basing Diag.	Volts	Amps.														
6853 (3)	T-9	Diode	8HE	5.0	1.700	F-W Rect.	350 Vac Per Plate	500 Vac Per Plate	RMS	125 Ma.	Output Current	Condenser Input to Filter.						
6854	T-6½	Duotriode	9FV	6.3	0.500	Amplifier	1.65	150	240	8.2	6500	5225	35		
6870	T-6½	Beam Pent.	9BF	6.3	0.600	VHF Power Amplifier	6.9	250	120	250	25.0	3.5	230	8500		
6872	T-3	Pentode	6872	6.3	0.200	VHF Amp.	1.1	120	200	120	7.75	2.7	340000	4100		
6877	T-6½	Power Triode	9GB	6.3	0.800	Power Amp.	150	12	75	2000	6500	3.75	12000		
6883 (3)	T-12	Beam Pent.	7CK	12.6	0.625	Power Amp.	20	Characteristics Same as Type 6146.									
6893	T-9	Beam Pent.	7CK	12.6	0.400	Power Amp.	10	Characteristics Same as Type 2E26.									
6900	T-6½	Duotriode	9H	6.3	1.000	Pulse Amp.	4.25	120	2	36	1700	11500	18.5		
6919	T-5½	Duodiode	6BT	6.3	0.200	F-W Rect. Computer	Maximum Inverse Peak Plate Voltage = 300 Volts. Maximum Peak Plate Current = 30 Ma. Maximum D.C. Output Current = 10 Ma. (Design Max. Values.)									
6922	T-6½	Duotriode	9AJ	6.3	0.300	VHF Amp.	1.65	90	120	12	2800	11500	33		
6939	T-6½	Duotetrode	9HL	6.3	0.600	P.P.A1 Amp.	3.0	150	3.5	150	27-31.6	3.6-12.2	7000	10560	1750		
6943 (3)	T-3	Pentode	8DC	6.3	0.175	R-F Amp.	1.0	100	150	100	8	2.3	300000	3600		
6944 (3)	T-3	Pentode	8DC	6.3	0.175	R-F Amp.	1.0	100	150	100	7	2.1	280000	3200		
6945 (3)	T-3	Beam Pent.	8DL	6.3	0.350	Power Amp.	3.0	100	270	100	25	1.5	20000	3500	3000	800		
6946 (3)	T-3	Triode	8DK	6.3	0.175	Amplifier	1.5	100	270	9.0	3800	16.5		
6947 (3)	T-3	Duotriode	8DG	6.3	0.350	Amplifier	0.75	150	270	6.5	4000	35		
6948 (3)	T-3	Duotriode	8DG	6.3	0.350	Amplifier	0.50	100	150	0.8	1650	70		
6954	T-5½	Pentode	7CM	6.3	0.300	Dual-Control Computer	3.3	150	1.0	150	5.8	6.6	50000	2050	Grid No. 3 = -3.0 Volts.		
6955	T-6½	Duotriode	9A	6.3	0.350	Amplifier	3.0	100	0	13.0	5800	3500	21.3		
6968	T-5½	Pentode	7BD	6.3	0.175	VHF Amp.	1.81	Characteristics Same as Type 6AK5.									
6973	T-6½	Beam Pent.	9EU	6.3*	0.450	S.T. A1 Amp. P.P.AB1 Amp. P.P.AB1 Amp.	13.2	250	15	250	46	3.5	73000	4800	5500	15000†	
7001	T-5½	Beam Tetrode	7EJ	6.3	0.450	Power Amp.	5.5	120	250	120	35	4	4800		
7025 7025A	T-6½	Duotriode	9A	12.6 6.3	0.150 0.300	Audio Amp.	1.1	Characteristics Same as Type 12AX7, except Controlled for Noise and Hum.									
7027 7027A	T-12	Beam Pent.	8HY	6.3	0.900	P.P.AB1 Amp.	27.5	330	24	330	122-184†	5.6-18.5†	4500†	31500		
								400	25	300	102-152†	6-17†	6600†	34000		
								450	30	350	95-194†	3.4-19.2†	6000†	50000		
								400	200	300	112-128†	7-16†	6600†	32000		
								380	180	380	138-170†	5.6-20†	4500†	36000		
								410	220	410	134-155†	(Cathode Current) Ultra-Linear Circuit.	8000†	24000		
7032	T-5½	Heptode	7CH	6.3	0.300	Computer	1.1	150	G1+3=0	75	3.5	6.0	G3+1=470K	1400	G1 = Control Grid		
								150	G1+3=0	75	3.5	6.0	G3+1=470K	650	G3 = Control Grid		
								150	6.0	75	<0.1	<0.3	G3+1=470K	G3 = 0 Volts		
								150	0	75	<0.1	8.8	G3+1=470K	G3 = -6 Volts		
7036	T-5½	Heptode	7CH	6.3	0.300	Dual Control Computer	0.9	Characteristics Same as Type 5915A.									
7044 GB-7044 (3)	T-6½	Duotriode	9H	6.3 12.6	0.900 0.450	Computer	4.5	120	2.0	36	1750	12000	21		
7054	T-6½	Power Pent.	9BF	13.5	0.275	S.T.A1 Amp. Class "C" Amplifier	5.0	250	120	150	19	3.5	100000	11500		
								300	12	175	26	5.5	4000		

(1) See Frontal Section. (2) Design Maximum Values. (3) Has Special Mechanical and/or Life Characteristics. (4) Average Contact Potential Bias Developed Across Specified Grid Resistor. † Maximum Signal. ‡ Filamentary Type. †† Conversion Transconductance. ††† Plate to Plate. †††† Cathode Resistor (ohms).

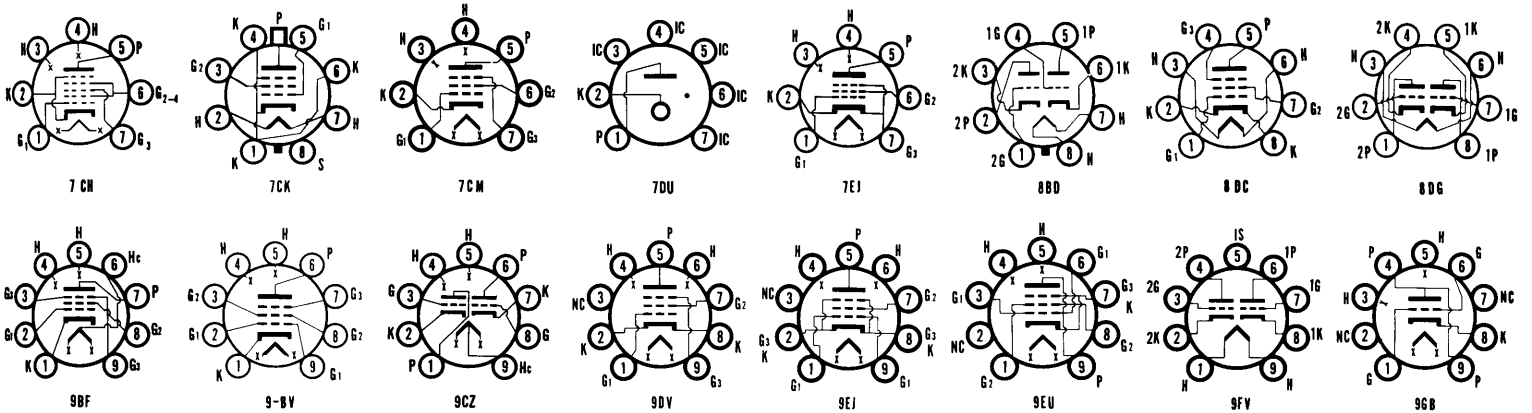

SYLVANIA TUBES

TYPE	CONSTRUCTION			EMITTER		USE	Plate Diss. Watts ²	Plate Volts	Negative Grid Volts	Screen Volts	Plate Current Ma.	Screen Current Ma.	Plate Resis. Ohms	Transconductance Micros.	Amplification Factor	Ohms Load for Stated Power Output	Power Output Milli-watts
	Bulb Size or Style ¹	Class	Basing Diag.	Volts	Amps.												
7055	T-5½	Duodiode	6BT	13.5	0.155	Detector	...	117 A.C. Volts Per Plate, RMS, 9 Ma. Output Current.	300 Ohms Min.	Effective Plate Supply Imp.
7056	T-5½	Pentode	7CM	13.5	0.150	VHF Amp.	2.0	200	180	150	9.5	2.8	600000	6200
7057	T-6½	Duotriode	9AJ	13.5	0.180	VHF Amp.	2.2	150	220	...	10	...	5300	6800	36
7058	T-6½	Duotriode	9A	13.5	0.155	A-F Amp.	1.0	250	2	...	1.25	...	61000	1650	100
7059	T-6½	Tri. Pentode	9AE	13.5	0.195	VHF Osc. VHF Amp.	2.5 2.8	150 250	56 [■] 68 [■]	...	18 10	...	4700 400000	8500 5200	40
7060	T-6½	Tri. Pentode	9DX	13.5	0.280	VHF Osc. VHF Amp.	2.5 3.0	150 200	150 [■] 82 [■]	...	9 15	...	8200 150000	4900 7000	40
7061	T-6½	Beam Pent.	9EU	13.5	0.210	S.T.A1 Amp.	9.0	200	10	200	35.5	9	60000	4200	...	5000	3000
7077	Ceramic and Metal	Triode	7077	6.3	0.240	UHF R-F Amplifier	1.0	250	82 [■]	...	6.4	...	8900	9000	80
7105	T-12	Duo Power Triode	8BD	12.6	1.250	Passing Tube for V.R. Serv.	13.2	Characteristics Same as Type 6080WA.									
7119	T-6½	Duotriode	9H	6.3 12.6	0.640 0.320	Computer	4.5	120 150	2.0 14	...	36 0.2	15000	24
7137 GB-7137 (3)	T-5½	Triode	7BQ	6.3	0.225	VHF Amp.	2.25	150	100 [■]	...	13.5	8500	40
7150	Spec. Base T-9	Tetrode	9JH	6.3	0.450	VHF Amp.	4.0	135	G1 = +8V RK = 260 Ohms	135	27.5	8.5	30000	35800
7167	T-5½	Tetrode	7EW	13.5	0.090	VHF Amp.	2.0	250	1.0	80	10	1.4	125000	8000
7189	T-6½	Beam Pent.	9CV	6.3	0.760	S.T.A1 Amp. P.P.AB1 Amp. P.P.AB1 Amp.	13.2	250 400 375	7.3 15 220 [■]	250 300 375	48 15-105† 75-81†	5.5 1.6-25† (Cathode Current)	40000	11300	19.5	(G1 to G2)	24000 16500
7199	T-6½	Tri. Pentode	9JT	6.3	0.450	A-F Tri. Amp. A-F Pent. Amplifier	2.4 3.0	215 100 220	8.5 1000 [■] 62 [■]	...	9 50 130	1.1 0.35 3.5	8100 1 Meg. 0.4 Meg.	2100 1500 7000	17
7212	T-12	Beam Pent.	8EC	6.3	1.250	P.P.AB1 Amp. P.P.AB1 Amp. P.P.AB2 Amp.	20	600 500 600	45 40 44	180 185 165	26-200† 57-215† 22-207†	1-23† 2-25† 0.6-17†	7000 5500 6800	82000 70000 90000
7227	T-6½	Pentode	9BA	27.5	0.175	Power Amp.	2.2	27.5	2.5	27.5	11	1.1	8000	5500	4	...	70
7233	T-6½	Triode	9FR	6.3	1.250	Passing Tube for V.R. Serv.	7.5	50	22 [■]	...	120	...	230	17500	4
7236	T-12	Duotriode	8BD	6.3	2.400	Passing Tube for V.R. Serv.	15	120	14	...	100	12500	4.8
7239	T-6½	Beam Pent.	9KH	6.3	0.300	Pulse Amp. and Shunt Reg.	4.0	300 100	5.0 ...	100 100	10.5 43	2.6 13.5	300000 Grid No. 1 = 400 μa.	4200	...	(Applied for Short Intervals—2 Sec. Max.)	...
7241	TT-18	Triode	7241	6.3	7.500	Passing Tube for V.R. Serv.	100	190	200 [■] RG = 500 Ohms	...	550	...	67	40000	2.7
7242	TT-18	Triode	7241	6.3	7.500	Passing Tube for V.R. Serv.	100	100	4 RG = 500 Ohms	...	555	...	82	110000	9.0
7244 7244A	T-5½	Duotriode	7BF	6.3	0.450	Amplifier	1.1	100	50 [■]	...	9.0	...	6300	6000	38
7245	T-5½	Triode	7BQ	6.3	0.400	VHF Amp.	2.25	150	100 [■]	...	13.5	...	4500	11000	50
7246	T-2x3	Triode	7246	1.25	0.150	VHF Amp./Osc./Det.	0.7	105	2.5	...	4.5	2700	22
7258	T-6½	Tri. Pentode	9DA	13.5	0.210	Gen. Amp. VHF Amp.	2.8 2.3	150 125	3 56 [■]	...	15 12	...	4700 170000	4500 7800	21
7316	T-6½	Duotriode	9A	6.3 12.6	0.300 0.150	Computer	2.7	250 100	8.5 0	...	10.5 11.8	...	7700 6250	2200 3100	17 19.5
7318	T-6½	Duotriode	9A	6.3 12.6	0.350 0.175	Pulse Amp.	1.35	100 250	0 8.5	...	13 11.5	...	5800 7000	3500 2350	21.3 16.5

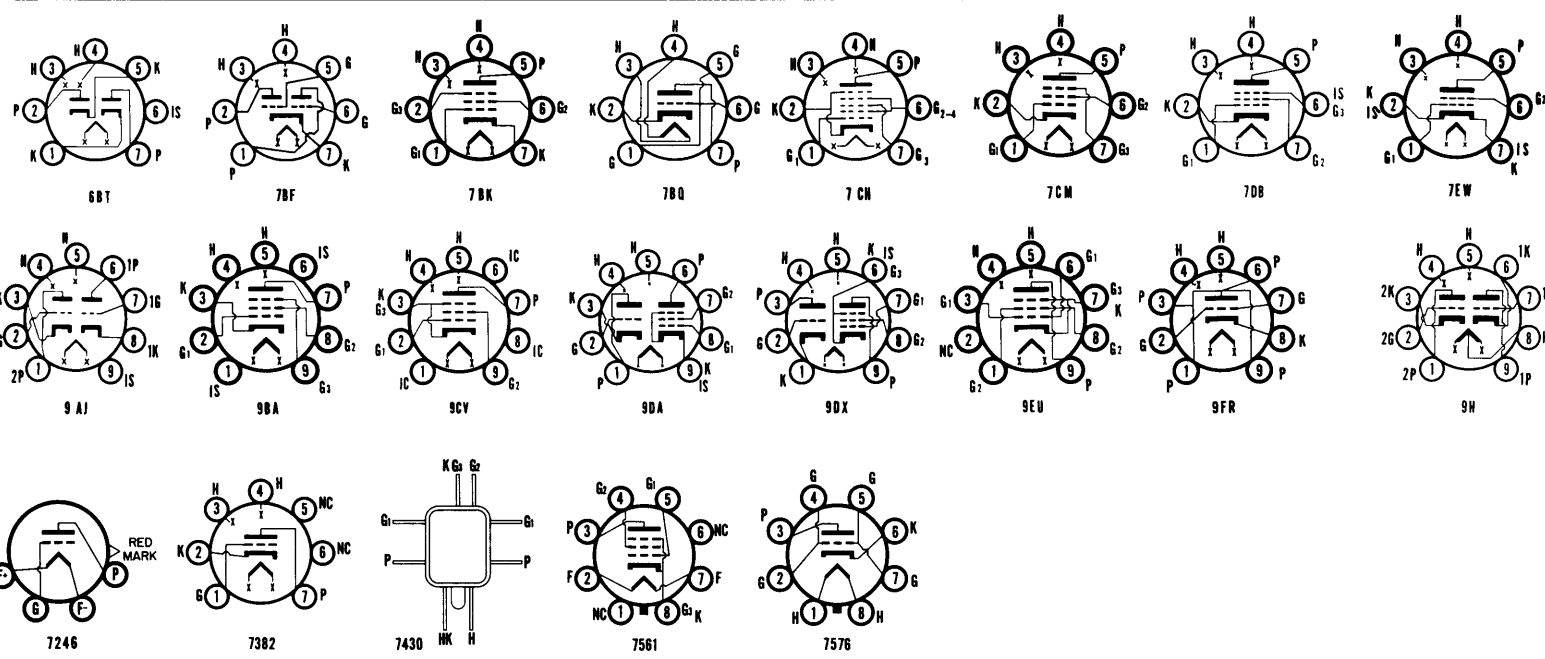

AVERAGE CHARACTERISTICS

TYPE	CONSTRUCTION			EMITTER		USE	Plate Diss. Watts ²	Plate Volts	Negative Grid Volts	Screen Volts	Plate Current Ma.	Screen Current Ma.	Plate Resis. Ohms	Transconductance Micros.	Amplification Factor	Ohms Load for Stated Power Output	Power Output Milli-watts
	Bulb Size or Style ¹	Class	Basing Diag.	Volts	Amps.												
7320	T-6½	Beam Pent.	9CV	6.3	0.760	Power Amp.	12	Characteristics Same as Type 6BQ5.									
7327 (3)	T-3	Duotriode	8DG	6.3	0.300	Pulse Amp. Blocking Osc.	0.95	150	25	Pulse Applied to Grid = 40 Volts at $T_p = 10 \mu\text{sec.}$, $P_{rr} = 1000 \text{ Pps.}$, $T_r = 0.2 \mu\text{sec. Max.}$, $T_f = 0.2 \mu\text{sec. Max.}$, —PEAK Plate Current = 400 Ma. Min.							
7355	T-9	Beam Pent.	8KN	6.3	0.800	S.T.A1 Amp. P.P.AB1 Amp. P.P.AB1 Amp.	18	250 300 400	15 21 34	225 250 300	62-74† 100-185† 56-175†	3.2-16.5† 5.5-24† 3.5-24†	42000	7600	2500 4000† 5000†	9000 28500 40000
7358	T-12	Pentode	8EC	6.3	1.250	Pulse Mod.	10	200 3000 175	200 300	100 15 4	7000	4.2 (G2 to G1)
7360	T-6½	Beam Defl. Tube	9KS	6.3	0.350	Balanced Mod. Dble. Sideband Balanced Mixer Single Sideband	1.5 1.5	150 25 Volts = Defl. Electrode Voltage, PK to PK R-F Grid No. 1 Volts = 10 Volts, Push-Pull Double Sideband Output Voltage = 4 Volts.	1200 [■] 150 1200 [■]	175 175	1.5 1.5	0.75 0.75	5000† 10000†
7370	T-6½	Duotriode	9H	20/40	0.260/0.130	Computer	4.75	120 250	2.0 12.5	36 12	1560 3000	11500 5400	18 16
7382	T-5½	Triode	7382	6.3	0.300	A-F Amp.	0.55	Characteristics Same as Type 12AX7, except Controlled for Noise and Hum.									
7408	T-9	Beam Pent.	7S	6.3	0.450	A-F Pwr. Amp.	14	Characteristics Same as Type 6V6GT.									
7430	Special	Pentode	7430	6.3	0.200	R-F Amp.	1.87	120 180	2.0 2.0	120 120	7.5 7.7	2.5 2.4	300000 500000	5000 5100
7489	T-6½	Duotriode	9A	6.3/12.6	0.300/0.150	A-F Amp.	3.0	250	8.5	10.5	7700	2200	17
7490	T-6½	Duotriode	9A	6.3/12.6	0.600/0.300	A-F/D.C. Amp.	5.0	250	4.6	6.0	2350	32
7492	T-6½	Duotriode	9DA	6.3/12.6	0.300/0.150	R-F Amp. and Computer	2.8	250	200 [■]	10	5500	60
7494	T-6½	Duotriode	9A	12.6/6.3	0.150/0.300	A-F Amp.	1.1	250	2	1.25	59000	1600	95
7495	T-6½	Beam Tetrode	9K	6.0	0.750	VHF Power Amplifier	12	250	7.5	250	45	7 Max.	7000	G1 to G2 = 16.
7496	T-5½	Pentode	7BK	6.3	0.300	R-F Amp.	3.3	250	68 [■]	100	11	4.2	1 Meg.	4400
7498	T-5½	Pentode	7DB	6.3	0.300	R-F Amp.	3.0	250	160 [■]	250	9.85	2.6	7620	75
7499	T-6½	Pentode	9BA	6.3	0.750	Video Amp.	12	250	4.5	250	40	6.0	11000	26
7500	T-6½	Beam Tetrode	9AH	6.3	0.450	A-F Power Amplifier	13	250	12.5	250	45	5.5	50000	4100
7502	T-5½	Heptode	7CH	6.3	0.300	Converter	1.1	250	1.5	100	3.0	7.5	1.0 Meg.	7250
7543	T-5½	Pentode	7BK	6.3	0.300	A-F Amp.	3.3	Characteristics Same as Type 6AU6. Type 7543 has a Folded Coil Heater for Low Noise Operation.									
GB-7550 7550 (3)	T-3	Duotriode	8DG	6.3	0.525	Pulse Amp.	2.0	300	30	1400
7561	T-9	Beam Pent.	7561	25	0.300	S.T.A1 Amp. S.T.A1 Amp. S.T.AB1 Amp.	13	115 250 250	8.0 15 18	115 150 150	55 48-51† 50-110†	2.5 1-7† 8-14†	8000 10000	10000	5000 3000	6000 17000
7576	T-3	Triode	7576	6.3	0.450	VHF Amp.	4.1	200	0	15.5	10700	46
7581	T-12	Pentode	7S	6.3	0.900	P.P.AB1 Amp.	35	360 360 450	22.5 22.5 37	270 270 400	88-132† 88-140† 116-210†	5-15† 5-11† 5.6-22†	6600† 3800† 5600†	26.5 18 55	
7581A	T-12	Beam Pent.	7S	6.3*	0.900	S.T.A1 Amp. P.P.AB1 Amp. P.P.AB1 Amp.	35	250 360 450	14 22.5 37	250 270 400	72 88-132† 116-210†	5 5-15† 5.6-22†	22500	6000	2500 6600† 5600†	6500 26500 55000
7586	M-N	Triode	12AQ	6.3*	0.140	VHF Amp.	1.0	75	100 [■]	10.5	3000	11500	35

(1) See Frontal Section.

(3) Has Special Mechanical and/or Life Characteristics.

* Controlled Heater Warm-up Time (applies to parallel connections of types having a tapped heater.)

(2) Design Maximum Values.

(4) Average Contact Potential Bias Developed Across Specified Grid Resistor.

† Maximum Signal.

◆ Filamentary Type.

▲ Conversion Transconductance.

¶ Plate to Plate.

■ Cathode Resistor (ohms).

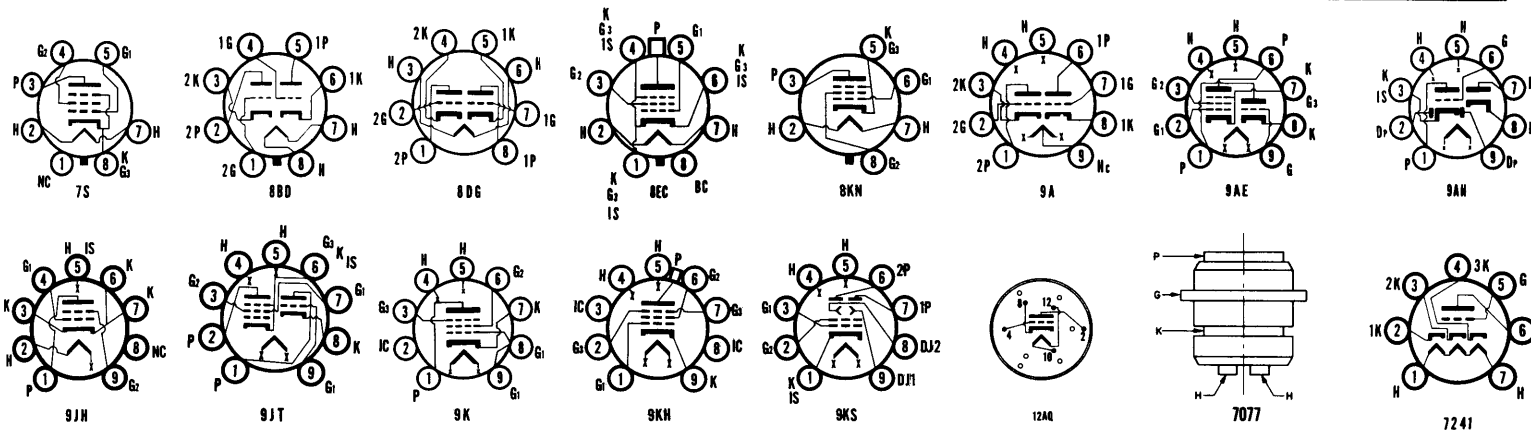

SYLVANIA TUBES

TYPE	CONSTRUCTION			EMITTER		USE	Plate Diss. Watts?	Plate Volts	Negative Grid Volts	Screen Volts	Plate Current Ma.	Screen Current Ma.	Plate Resis. Ohms	Transconductance Micros.	Amplification Factor	Ohms Load for Stated Power Output	Power Output Milli-watts			
	Bulb Size or Style*	Class	Basing Diag.	Volts	Amps.															
7587	M-N	Tetrode	12AS	6.3	0.150	VHF Amp.	2.2	125	68 [■]	50	10	2.7	200000	10600			
7591	T-9	Beam Pent.	8KG	6.3	0.800	S.T.A1 Amp. P.P.AB1 Amp. P.P.AB1 Amp. P.P.AB1 Amp. P.P.AB1 Amp. P.P.AB1 Amp. P.P.AB1 Amp. P.P.AB1 Amp.	19	300 300 350 400 450 450 450 400 425	10 12.5 15.5 16 16.5 21 200 20.5 185 [■]	300 300 350 350 350 400 400	55-65† 86-116† 92-130† 85-143† 77-153† 66-144† 82-94† 80-138† 88-104†	7-16† 12-26† 13-29† 11-27† 10-27† 9.4-30† 11.5-22† 11.5-26† 13-17.5†	29000	10200
7591A	T-9	Beam Pent.	8KG	6.3	0.800	S.T. A1 Amp. P.P. AB1 Amp.	19	Characteristics Same as Type 7591 Except for Controlled Zero Bias Plate and Screen Current and Low Loss Base.												
7631	T-5½	Duodiode	6BT	6.3	0.300	Detector	Max. Peak Inverse Plate Voltage = 360 Volts. Max. Peak Plate Current = 10 Ma. Max. Surge Plate Current = 350 Ma.												
7643	T-6½	Tri. Pent.	9AE	6.3	0.330	VHF Amp./Osc.	1.7 2.1	100 170	120 [■] 155 [■] 170	14 10 2.8 400000	5000 6200	18 40			
7687	T-6½	Tri. Pentode	9AE	6.3	0.500	A-F Amp.	2.4 3.0	215 220	8.5 62 [■] 130	7.5 10 3.4	7200 500000	2500 5800	18			
7688	Special Base T-7½	Triple Triode	12BA	6.3	0.450	A-F Amp.	3.0	Characteristics Same as Type 12AU7.												
7689	Special Base T-7½	Triple Triode	12BA	6.3	0.450	A-F Amp.	1.1	Characteristics Same as Type 12AX7.												
7690	Special Base T-7½	Triple Triode	12BA	6.3	0.450	A-F Amp.	2.8	Characteristics Same as Type 12AT7.												
7693	T-5½	Pentode	7EN	6.3	0.150	R-F Amp.	2.6	250	100 [■]	150	7.4	2.9	1.3 Meg.	4600	G1 to G2=48				
7694	T-5½	Pentode	7EN	6.3	0.150	R-F Amp.	3.3	250	80 [■]	100	9.2	3.3	1.0 Meg.	3800	G1 to G3=25				
7695	9-T9	Pentode	9PX	50	0.150	S.T.A1 Amp. P.P.AB1 Amp.	16	130 140	11 50 [■]	130 140	100 210-220†	5-14† 9-20†	7000	11000	1100 1500 [■]	4500 10000			
7701	T-6½	Beam Pent.	9MS	13.6	0.160	VHF Class C Amplifier	9.0	250	12.5	250	28	3.1	31000	3600			
7716	T-6½	Tri. Pentode	9DX	13.6	0.350	High Mu High GM	1.0 5.0	125 200	1.0 68 [■] 125	1.5 24 5.2	35000 70000	2900 10000	102			
7717	T-5½	Tetrode	7EW	6.3	0.200	VHF Amp.	2.0	125	1.0	80	10	1.4	125000	8000			
7719	T-6½	Triode	9MX	12.6/ 6.3	0.225/ 0.450	Computer	6.0	300	10.5	4	7100	3500	25			
7720	Ceramic and Metal	Triode	7720	6.3	0.240	VHF Amp.	1.0	150	82 [■]	7.5	10500	90			
7721	T-6½	Pentode	9EQ	6.3	0.320	VHF Amp.	4.0	190	400 [■]	160	22	6.0	120000	35000			
7722	T-6½	Pentode	9EQ	6.3	0.320	VHF Amp.	4.0	190	370 [■]	160	20	6.0	100000	26000			
7724	T-6½	Duodiode Tri.	9KR	14	0.150	A-F Amp.	250	3.0	0.7	72000	1000	72			
7728	T-6½	Duotriode	9A	6.3/ 12.6	0.300/ 0.150	VHF Amp.	2.8	Characteristics Same as Type 12AT7.												
7729	T-6½	Duotriode	9A	6.3/ 12.6	0.300/ 0.150	A-F Amp.	1.1	Characteristics Same as Type 12AX7.												
7730	T-6½	Duotriode	9A	6.3/ 12.6	0.300/ 0.150	Gen. Purpose	3.0	Characteristics Same as Type 12AU7.												
7731	T-6½	Tri. Pent.	9AE	6.3	0.450	VHF Osc. VHF Amp.	3.0 3.0	Characteristics Same as Type 6U8.												
7732	T-5½	Pentode	7CM	6.3	0.300	VHF Amp.	2.3	Characteristics Same as Type 6CB6.												
7733	T-6½	Pentode	9BF	6.3/ 12.6	0.600 0.300	Video Amp.	6.5	Characteristics Same as Type 12BY7A.												
7734	T-6½	Tri. Pentode	9LC	6.3	0.900	V.R. Voltage Control Tube	7.0 1.0	150 150	21 2.0 150	35 5.5 1.7	1080 340000	5000 3200	5.4			

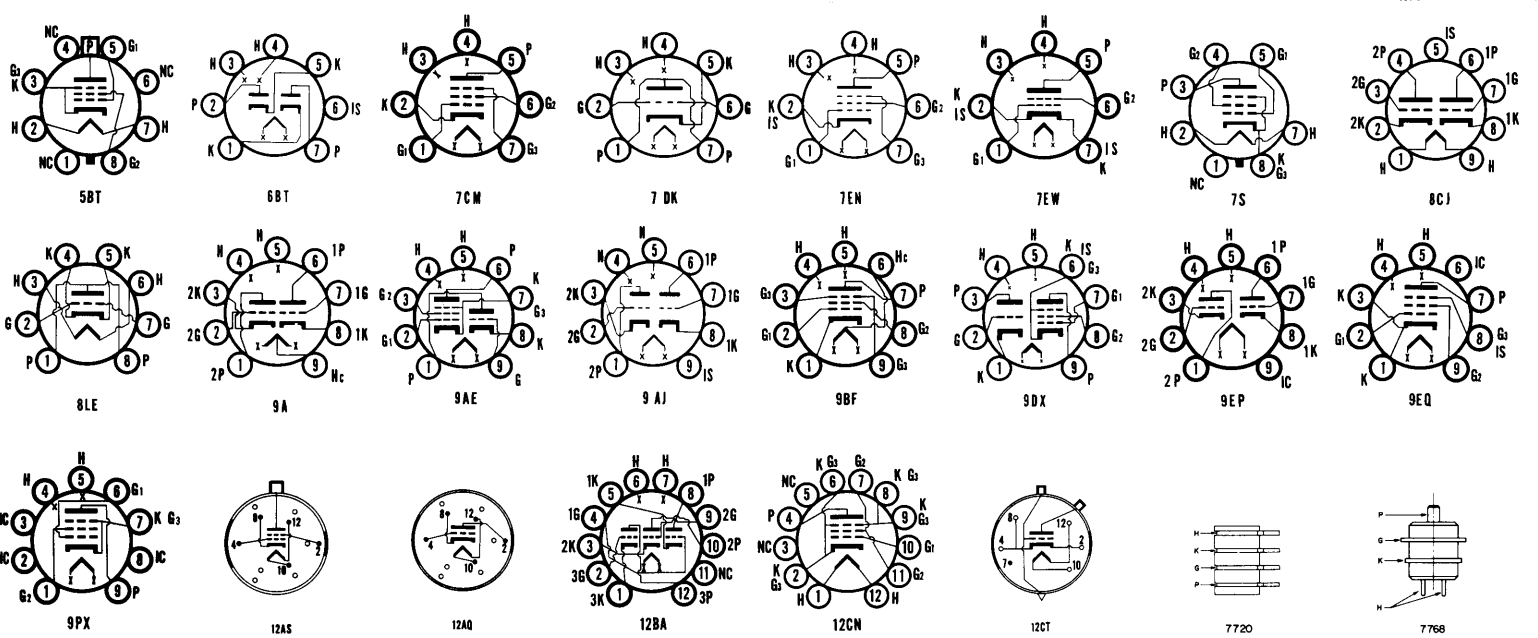

AVERAGE CHARACTERISTICS

TYPE	CONSTRUCTION			EMITTER		USE	Plate Diss. Watts ¹	Plate Volts	Negative Grid Volts	Screen Volts	Plate Current Ma.	Screen Current Ma.	Plate Resis. Ohms	Transconductance Micros.	Amplification Factor	Ohms Load for Stated Power Output	Power Output Milli-watts	
	Bulb Size or Style ¹	Class	Basing Diag.	Volts	Amps.													
7737 (3)	T-6½	Pentode	9M2	6.3	0.320	Amplifier	3.0	180	100 [■]	150	11.5	2.9	15900	
7738	T-5½	Triode	7DK	6.3	0.225	VHF Class C Amplifier	5.0	200	100 [■]	12	9500	80	
7751	T-9	Beam Pent.	7S	6.3	1.200	Pulse Amp.	10	100	8.2	100	100	7	5000	14000	G1 to G2=5.6		
7754	9-T9	Beam Pent.	9PX	6.3	1.200	A-F Power Amplifier	16	Characteristics Same as Type 7695.										
7759	T-3	Duotriode	8DG	26.5	0.090	VHF Amp./Osc.	1.1	100	150 [■]	6.5	5400	35	
7760	T-3	Duotriode	8DG	26.5	0.090	VHF Amp./Osc.	26.5	2.2 Meg ⁴	3	5000	20	
7761	T-3	Pentode	8DL	26.5	0.110	Video Amp.	4.0	150	100 [■]	100	21	4	50000	9000	
7762	T-3	Beam Pent.	8DL	26.5	0.110	S.T. A1 Amp.	4.0	110	270 [■]	110	30	2.2	15000	4200	3000	1000	
7763 (3)	T-6½	Sheet Beam Tube	9NF	6.3	0.300	I-F Amp. Limiter	0.75	135	Acc. and Screen = 300 Volts. Total Plate Current = 4.2 Ma. Deflection Electrode = 135 Volts. Acc. and Screen Current = 4.0 Ma.									
7768	Ceramic and Metal	Triode	7768	6.3	0.400	VHF Amp.	5.5	200	270 [■]	24	4500	50000	225	
7803	T-6½	Duotriode	9AJ	6.3	0.365	V-F Osc. Doubler	3.5	90	1.3	15	12500	33	
7841	Ceramic and Metal	Diode	7841	6.3	0.215	Detector	Max. Peak Inverse Plate Voltage = 350 Volts. Max. D.C. Output Current = 5.0 Ma.										
7861	T-6½	Duotriode	8CJ	12.6	0.175	Gen. Purpose	1.3	150	240 [■]	8.2	6400	5500	35	
7867	T-12	Beam Pent.	5BT	6.3	2.500	S.T. A1 Amp. P.P.AB1 Amp. P.P.AB1 Amp.	24	250	120 [■]	90	80	1.0	12000	10000	3000	7500	
								250	200 [■]	150	114-128†	2-17†	6000†	28000	
								250	35	150	58-210†	1.4-26†	5000†	65000	
7868	Novar T-9	Beam Pent.	9NZ	6.3	0.800	S.T. A1 Amp. P.P.AB1 Amp. P.P.AB1 Amp.	19	300	10	300	60	8	29000	10200	3000	11000	
								300	12.5	300	74-116†	10-28†	6600†	24000	
								400	16	350	64-135†	8-28†	6600†	34000	
7887	T-3	Duotriode	8DG	26.5	0.090	Osc./Amp.	1.1	100	220 [■]	8.5	5000	20	
7888	T-3	Triode	8DK	26.5	0.045	UHF Osc.	1.0	100	150 [■]	8.5	5800	27	
								150	180 [■]	13	6000	27	
7889	T-3	Duotriode	8DG	26.5	0.090	A-F Amp.	0.55	100	1500 [■]	0.8	1800	70	
								150	820 [■]	1.75	2500	70	
7898	T-6½	Duotriode	9EP	13.5	0.150	VHF Osc./Amp.	2.75	250	200 [■]	10	10900	5500	60	
7905	T-6½	Beam Pent.	9PB	6.3	0.650	VHF Class "C" Power Amp.	10	200	6	185	36	2.5	6700	
								300	39	185	60	4	RG1 = 18 K Ohms, Driving Pwr. = 1 Watt Pk R-F Grid Volts = 43 Volts	7000		
7984	T-12	Beam Pent.	12CN	13.5	0.580	Class "C" Amp. 175 Mc.	35	200	7.5	125	125	4.5	13500	
								750	150	250	180	12	Driving Pwr. = 2 Watts at 2.5 Ma.	46000		
7994	T-3	Triode	8KM	6.3	0.250	VHF Amp.	2.0	100	82 [■]	13.0	2200	18000	41	
7995	T-3	Pentode	8KZ	6.3	0.250	R-F I-F Amp.	1.6	150	160 [■]	150	8.0	2.0	85000	13000	
8056	M-N	Triode	12AQ	6.3	0.135	VHF Amp.	0.45	24	100 [■]	8.7	1530	7500	11.5	
8058	M-N	Triode	12CT	6.3	0.135	UHF Amp.	1.5	110	47 [■]	10	5600	12400	70	
8064	T-3	Beam Pent.	8DL	26.5*	0.045	VHF Amp.	0.75	100	120 [■]	100	7.2	2	275000	4500	
8068	T-12	Beam Pent.	8LC	6.3	0.900	Series Reg.	35	3500	30	100	1.0	
								600	7.5	125	36	1.0	54500	5200	
8070	T-3	Triode	8LD	6.3	0.125	UHF Amp.	1.0	110	130 [■]	7.5	11000	58	
8071 (3)	T-3	Triode	8LE	6.3	0.125	UHF Amp.	2.0	150	100 [■]	11.5	12000	56	

(1) See Frontal Section.

(2) Design Maximum Values.

† Maximum Signal.

(3) Has Special Mechanical and/or Life Characteristics.

(4) Average Contact Potential Bias Developed Across Specified Grid Resistor.

♦ Filamentary Type.

▲ Conversion Transconductance.

* Controlled Heater Warm-up Time (applies to parallel connections of types having a tapped heater.)

¶ Plate to Plate.

■ Cathode Resistor (ohms).

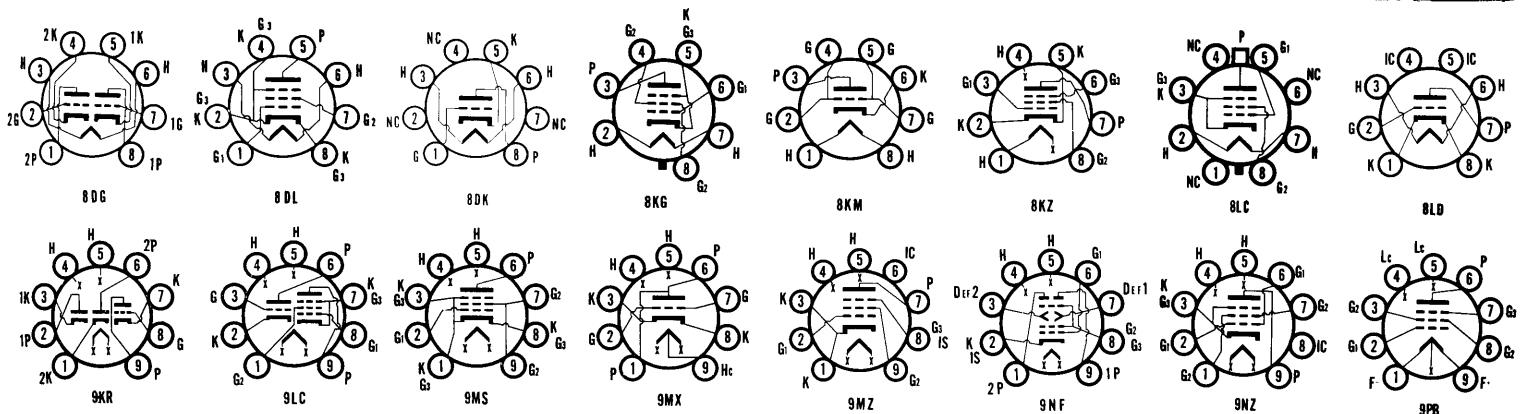

7841

SYLVANIA TUBES

TYPE	CONSTRUCTION			EMITTER		USE	Plate Diss. Watts ²	Plate Volts	Negative Grid Volts	Screen Volts	Plate Current Ma.	Screen Current Ma.	Plate Resis. Ohms	Transconductance Micros.	Amplification Factor	Ohms Load for Stated Power Output	Power Output Milli-watts
	Bulb Size or Style ¹	Class	Basing Diag.	Volts	Amps.												
8084 (3)	T-5½	Pentode	7CM	13.5	0.160	VHF Freq. Multiplier	2.3	125	1	80	7.0	1.7	10500
8102 (3)	T-6½	Tri. Pentode	9PJ	13.5	0.230	Gen. Purpose Amp.	2.5 2.5	125 125	1 1 125	13.5 12.0 4.0	5400 200000	8500 7500	46
8103 (3)	T-3	Double Tri.	8DG	26.5	0.075	UHF Amp. UHF Osc.	26.5	2.2 Meg. ⁴	5.5	11000	26
8106 (3)	T-6½	Pentode	9PL	13.5	0.250	Frequency Multiplier	6.0	300	3.5	150	16.0	3.2	90000	9000
8113 (3)	T-5½	Tetrode	7EW	6.3	0.200	R-F Amp.	2.0	120	2.0	120	10.0	2.3	20000	7000
8136	T-5½	Pentode	7CM	6.3	0.300	VHF Amp.	2.2	125	56 [■]	125	10.8	2.9	9800
8149	Comp. T-12	Beam Pent.	12DT	6.5 13.0	1.200 0.600	R-F Power Amp.	35.0	420	24	180	165	9.0	7500	4.5
8150	Comp. T-12	Beam Pent.	12DU	6.5 13.0	1.200 0.600	R-F Power Amp.	35.0	Characteristics Same as Type 8149. (8150 has Top Cap Construction.)									
8156	Comp. T-9	Beam Pent.	12EU	13.5	0.300	R-F Pwr. Amp.	15.0	200	9	125	75	3.5	7600
8185 (3)	T-3	Triode	8KM	6.3	0.300	R-F Pwr. Amp.	4.25	200	220 [■]	17.0	19000	42
8186 (3)	T-3	Triode	8KM	26.5	0.075	R-F Pwr. Amp.	4.25	Characteristics Same as Type 8185.									
8210 (3)	T-3	Pentode	8LS	6.3	0.125	VHF Mixer VHF Amp.	1.1	100	100 [■]	100	7.5	2.5	260000	8500
8211 (3)	T-3	Pentode	8DL	6.3	0.360	Video Amp.	4.0	150	62 [■]	100	17.0	4.2	65000	15500
8212 (3)	T-6½	Triode	9PY	6.3 12.6	0.460 0.230	Cathode Follower	10.0	105	75 [■]	25.0	965	29000	28
8213 (3)	T-3	Triode	8LT	6.3 12.6	0.380 0.190	Cathode Follower	5.0	105	75 [■]	23.0	1348	23000	31
8223 (3)	T-6½	Twin Triode	9AJ	6.3	0.475	A-F R-F Amp.	3.0	60	80 [■]	15	1850	14000	25
8233 (3)	T-9	Pentode	9PZ	6.3	0.600	Power Amp.	10.0	125	3	125	50	5.5	20000	45000	30
8254 (3)	T-3	Triode	8LW	6.3	0.185	High Freq. Probe Tube	1.5	80	2	14	14500	24
8278 (3)	Novar T-9	Tetrode	9QB	6.3	1.200	Power Amp.	25.0	250	12.5	250	100	8.0	7300	24000	14
8319 (3)	T-3	Triode	8LD	6.3	0.150	I-F R-F Amp.	1.0	100	160 [■]	7.5	14000	55
8334 (3)	T-5½	Triode	7DK	6.3	0.225	UHF Amp.	4.4	200	100 [■]	18	10750	55
8358	T-6½	Twin Beam Pent.	9QR	1.9	3.150	R-F Osc. R-F Pwr. Amp.	7.5	180	20	180	50	11.5	10000	30	4500
8380	M-N	Tetrode	12AS	6.0 to 8.5	Freq. Doubler R-F Osc.	1.6	100	68 [■]	50	11	2.6	11000

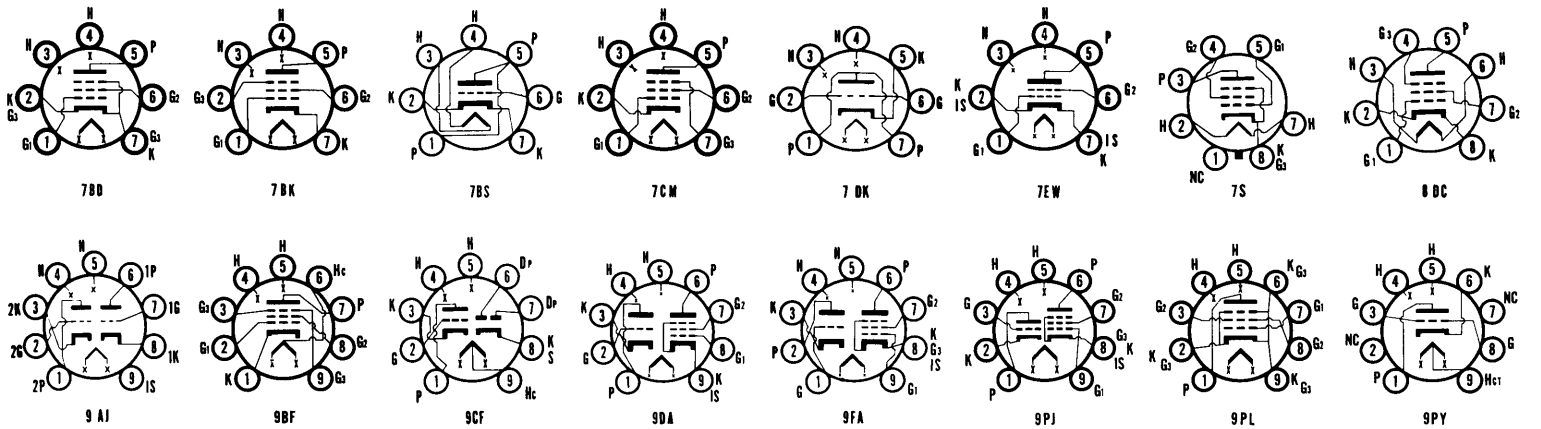

AVERAGE CHARACTERISTICS

TYPE	CONSTRUCTION			EMITTER		USE	Plate Diss. Watts ²	Plate Volts	Negative Grid Volts	Screen Volts	Plate Current Ma.	Screen Current Ma.	Plate Resis. Ohms	Trans-conductance Micros.	Amplification Factor	Ohms Load for Stated Power Output	Power Output Milli-watts
	Bulb Size or Style ¹	Class	Basing Diag.	Volts	Amps.												
8382	M-N	Triode	12AQ	6.0 to 8.5	Class C Amp. R-F Osc.	2.0	75	100 ⁴	15	...	2200	12800	28
8414 (3)	T-3	Pentode	8DC	26.5	0.045	VHF Amp.	26.5	2.2 Meg. ⁴	26.5	4.5	1.5	50000	5000
8417	T-12	Beam Pent.	7S	6.3	1.600	Power Amp.	35.0	300	12	300	100	5.5	16000	23000	165
8425 (3)	T-5½	Pentode	7BK	6.3	0.300	I-F R-F Amp.	3.5	250	68 ⁴	150	10.5	4.1	1100000	6200
8426 (3)	T-5½	Pentode	7BK	12.6	0.150	I-F R-F Amp.	3.5	Characteristics Same as Type 8425.									
8431	T-6½	Double Tri.	9AJ	12.6	0.180	Class C Amp.	3.5	90	1.3	15	12500	33
8441	M-N	Triode	12AQ	6.0 to 8.5	Amplifier	1.0	110	150 ⁴	7	...	6800	9400	64
8444 (3)	T-3	Pentode	8DC	6.3	0.125	VHF Amp.	1.1	100	100 ⁴	100	8.5	2.8	260000	9000
8445 (3)	T-6½	Triode Pent.	9AE	6.75	0.440	Gen. Purpose Amp.	2.0	100	1	12.5	7000	43
8446 (3)	T-6½	Triode Pent.	9FA	6.75	0.440	Gen. Purpose Amplifier	2.0	Characteristics Same as Type 8445.									
8447 (3)	T-6½	Double Diode Triode	9CF	6.75 to 13.5	0.380 to 0.190	Det. Amp.	Diode Voltage Drop for Ib = 17 Ma = 50 Volts.									
8448 (3)	T-6½	Pentode	9BF	6.75 to 13.5	0.520 to 0.260	Power Amp.	6.5	250	100 ⁴	180	26	5.7	10900	5500	60
8456 (3)	M-N	Triode	12AQ	6.0 to 8.5	Cathode Follower	0.45	24	100 ⁴	8.7	...	1530	7500	11.5
8489 (3)	T-6½	Tri. Pentode	9DA	6.3	0.450	Amplifier	2.8	150	3	15.0	...	4700	4500	21
9001	T-5½	Pentode	7BD	6.3	0.150	VHF Amp.	0.55	250	3.0	100	2.0	0.7	1 Meg. >	1400
9002	T-5½	Triode	7BS	6.3	0.150	Amplifier	1.76	250	7.0	6.3	...	11400	2200	25
9003	T-5½	Pentode	7BD	6.3	0.150	VHF Amp.	1.87	250	3.0	100	6.7	2.7	700000	1800
XXD	Now Listed as 14AF7/XXD																
XXFM	Now Known as Type 7X7																
XXL	Now Known as Type 7A4																

(1) See Frontal Section.

(3) Has Special Mechanical and/or Life Characteristics.

* Controlled Heater Warm-up Time (applies to parallel connections of types having a tapped heater.)

(2) Design Maximum Values.

(4) Average Contact Potential Bias Developed Across Specified Grid Resistor.

† Maximum Signal.

‡ Filamentary Type.

▲ Conversion Transconductance.

¶ Plate to Plate.

■ Cathode Resistor (ohms).

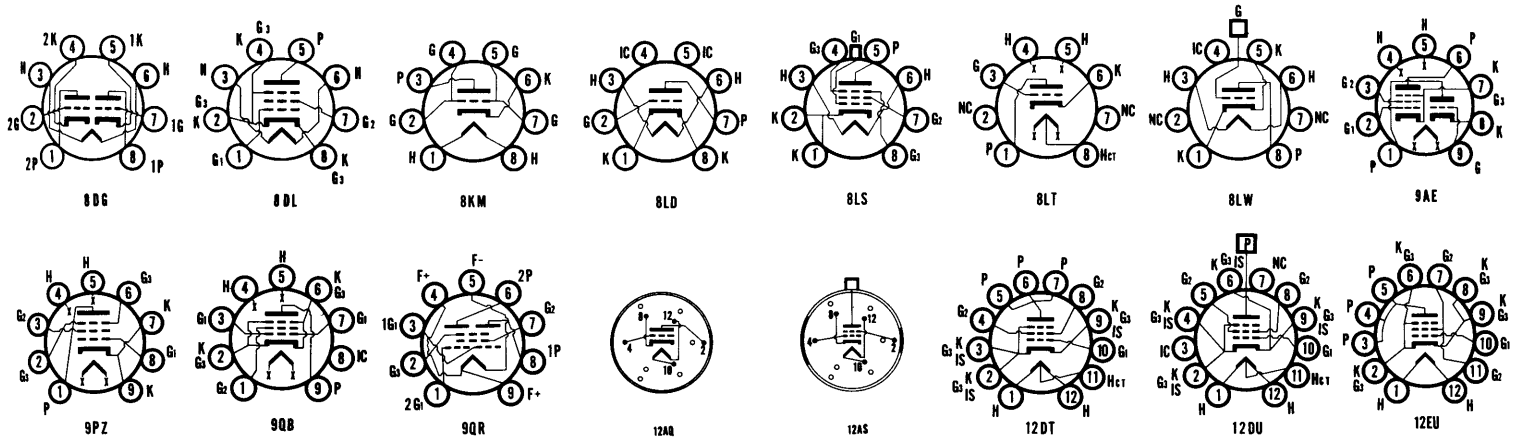

RESISTANCE COUPLED AMPLIFIER DATA

TYPE	TABLE	TYPE	TABLE
5AV8	B,C	13D2	K
5B8	B,C	18FY6	G
6AB4	A	19HV8	D
6AN8, 6AN8A, 5AN8	B,C	20EZ7	G
6AQ6	D	1273	M
6AS8, 5AS8	C	1280	M
6AT6, 12AT6	D	1620	M
6AU6, 6AU6A, 3AU6, 4AU6, 12AU6	E	5687	W
6AV6, 3AV6, 12AV6, 4AV6	G	5691	N
6AV11	L	5692	K
6AX8	H,I	5693	O
6B10	L	5751	G
6BE8, 5BE8	H,I	5879	V
6BF6, 12BF6	J	6072	R
6BJ8	K	6113	N
6BR8, 6BR8A, 5BR8	H,I	6118	D
6BT8, 5BT8	C	6135	L
6BY8	E	6136	E
6C4	L	6180	K
6C10	G	6201	A
6CG7, 8CG7	K	6267	U
6CH8	B,C	6320	N
6CN7, 8CN7	D	6321	K
6CR6	X	6678	H,I
6CU8	B,C	6679	A
6DR4	G	6680	L
6EU7	G	6681	G
6F5, 6F5GT, 12F5GT	F	7025, 7025A	G
6FM8	Y	7058	G
6FQ7, 8FQ7	K	7059	H,I
6J5, 6J5GT, 12J5, 12J5GT	K	7199	S,T
6J7, 6J7GT, 12J7GT, 12J7	M	7258	B,C
6K11	L,G	7316	L
6Q7, 6Q7GT, 12Q7GT	D	7382	G
6Q11	L,G	7543	E
6R7	J	7687	S,T
6SC7, 12SC7	N	7688	L
6SF5, 6SF5GT, 12SF5, 12SF5GT	F	7689	G
6SH7, 12SH7	E	7690	A
6SJ7, 6SJ7GT, 12SJ7, 12SJ7GT	O	7728	A
6SL7GT, 12SL7GT	N	7729	G
6SN7GTB, 8SN7GTB, 12SN7GTA	K	7730	L
6SQ7, 6SQ7GT, 12SQ7, 12SQ7GT	P	7731	H,I
6SR7, 12SR7	J	7889	D
6ST7	J	B36	K
6T8A, 5T8, 19T8	D	B65	K
6U8, 6U8A, 5U8, 9U8A	H,I	B152	A
7A4, 14A4	K	B309	A
7B4	F	B329	L
7B6, 14B6	P	B339	G
7C7, 14C7	M	DH77	D
7E6, 14E6	J	EABC80	D
7F7, 14F7	N	EBC90	D
7K7	N	EBC91	G
7N7, 14N7	K	EC90	L
12AT7	A	EC92	A
12AU7, 12AU7A, 9AU7, 7AU7	L	ECC81	A
12AV7	Q	ECC82	L
12AX7, 6AX7	G	ECC83	G
12AY7	R	ECF82	H,I
12AZ7A	A	EF86	U
12DM7	G	EF94	E
12DT7	G	H63	F
12DT8	A	HBC90	D
12DW7	G,L	HBC91	G
		HF94	E
		L63	K
		L77	L
		PCF82	H,I
		Z63	M

SYMBOLS USED

SYMBOL	FUNCTION	UNIT
Rb	Plate Load Resistor	Megohms
Rc2	Screen Dropping Resistor	Megohms
Rcf	Grid Resistor of Following Tube	Megohms
Ebb	Plate Supply Voltage	Volts
Eb	Plate Voltage at Plate	Volts
Ec or Ec1	Negative Grid Voltage	Volts
Ec2	Screen Grid Voltage	Volts
Esig	Input Signal	RMS Volts
Eout	Output to Following Grid	RMS Volts
Ib	Plate Current	Ma.
Ic2	Screen Grid Current	Ma.
Cc	Coupling Condenser	mfd.
Cc2	Screen By-pass Condenser	mfd.

Values of capacity are not specified since these are dependent mostly on the frequency characteristic required in each individual case.

$$\text{For low frequency limit} = f_1 \quad C_c = \frac{1.6 \times 10^6}{f_1 R_{cf}} \text{ mfd.}$$

$$C_k = \frac{1.6 \times 10^6}{f_1 R_k} \text{ mfd.} \quad C_{c2} = \frac{1.6 \times 10^6}{f_1 R_{c2}} \text{ mfd.}$$

Some text books show a more complicated method for calculating these by-pass condensers, but this method is quite rapid and gives conservative values. The loss due to incomplete by-passing will be less than 1% except for the cathode by-pass where it will be about 3%. The size condenser may be halved where economy is essential unless stages are cascaded and highest quality is required.

Table A

	Ebb = 100 Volts						Ebb = 250 Volts							
	.01		.027		.047		.01		.027		.047			
Rb														
Rcf	0.27	0.47	0.27	0.47	1.0	0.47	1.0	0.27	0.47	0.27	0.47	1.0	0.47	1.0
Rk	1500	1800	3900	3900	4700	5600	6800	680	680	1800	1800	2200	3300	3900
Ib	0.54	0.51	0.23	0.23	0.22	0.150	0.141	1.62	1.62	0.69	0.69	0.65	0.41	0.40
Ec1	-0.81	-0.92	-0.90	-0.90	-1.04	-0.840	-0.960	-1.10	-1.10	-1.24	-1.24	-1.43	-1.35	-1.56
Eb	45.2	48.1	37.1	37.1	39.6	28.7	32.7	86.9	86.9	62.3	62.3	75.6	55.7	59.9
Esig	0.1	0.1	0.1	0.1	0.1	0.1	0.1	0.1	0.1	0.1	0.1	0.1	0.1	0.1
Eout	3.0	3.0	2.8	3.0	3.1	2.95	3.0	3.90	4.10	3.55	3.70	3.65	3.50	3.60
Gain	30.0	30.0	28.0	30.0	31.0	29.5	30.0	39.0	41.0	35.5	37.0	36.5	35.0	36.0
% Dist.	1.9	1.7	1.9	1.7	1.4	1.8	1.4	.54	1.0	1.0	.92	.79	.89	.75
Esig (1)	0.54	0.29	0.30	0.29	0.38	0.22	0.34	0.61	0.49	0.54	0.56	0.71	0.64	0.77
Eout	6.6	8.7	8.4	8.4	11.5	6.5	10.0	23.0	19.7	19.0	20.6	25.5	22.1	27.0
Gain	30.0	30.0	28.0	28.9	30.3	29.5	29.4	37.0	40.2	35.2	36.8	35.9	34.5	35.1
% Dist.	3.9	4.7	5.0	4.5	4.9	3.6	4.1	4.4	4.2	4.7	4.2	4.6	4.8	4.6

Table B Triode Section

	Ebb = 100 Volts						Ebb = 250 Volts					
	.047		.01		.027		.047		.01		.027	
Rb												
Rcf	.1	.27	.1	.47	.27	.47	.1	.27	.1	.47	.27	.47
Rk	1200	1200	2200	3300	6800	8200	560	660	1000	1200	3900	3900
Ib	1.33	1.33	0.70	0.64	.275	.260	3.84	3.84	1.98	1.95	0.76	0.76
Ec1	-1.6	-1.6	-1.5	-2.1	-1.9	-2.1	-2.2	-2.2	-2.0	-2.3	-3.0	-3.0
Eb	36	36	29	34	24	28	66	66	50	53	42	42
Esig	.1	.1	.1	.1	.1	.1	.1	.1	.1	.1	.1	.1
Eout	1.25	1.27	1.13	1.22	1.10	1.12	1.45	1.50	1.37	1.44	1.25	1.28
Gain	12.5	12.7	11.3	12.2	11.0	11.2	14.5	15.0	13.7	14.4	12.5	12.8
% Dist.	0.9	0.9	0.9	0.7	0.6	0.6	0.7	0.7	0.7	0.7	0.5	0.5
Esig (1)	0.60	0.63	.60	.98	.88	1.07	1.17	1.17	1.02	1.28	1.65	1.65
Eout	7.4	8.0	6.8	11.5	9.7	12.0	17.0	17.5	14.0	18.5	20.7	21.1
Gain	12.3	12.7	11.3	11.7	11.0	11.2	14.5	15.0	13.7	14.4	12.5	12.8
% Dist.	4.7	4.5	4.6	4.9	4.7	4.3	5.2	5.0	5.0	4.6	4.8	4.2

Note (1) For Self Bias Operation This is Taken at the Grid Current Point With Less Than 1/2 μa. Grid Current.

RESISTANCE COUPLED AMPLIFIER DATA

Table S Triode Section

Rb	Ebb = 100 VOLTS						Ebb = 250 VOLTS					
	.047		0.10		0.27		.047		0.10		0.27	
Rcf	0.1	0.27	0.1	0.47	0.27	0.47	0.1	0.27	0.1	0.47	0.27	0.47
Rk	1500	1500	2700	3300	8200	8200	560	680	1200	1500	3300	3900
Ib	1.24	1.24	0.69	0.64	0.26	0.26	3.79	3.69	1.95	1.86	0.74	0.73
Ec1	-1.86	-1.86	-1.86	-2.11	-2.13	-2.22	-2.12	-2.51	-2.34	-2.79	-2.44	-2.85
Eb	39.8	39.8	29.1	33.9	27.7	24.9	69.9	74.0	52.7	61.2	47.6	50.2
Esig	0.5	0.5	0.5	0.5	0.5	0.5	0.5	0.5	0.5	0.5	0.5	0.5
Eout	5.4	5.7	5.2	5.4	4.8	5.0	6.8	6.8	6.2	6.4	5.7	5.7
Gain	10.8	11.4	10.4	10.8	9.6	10.0	13.6	13.6	12.4	12.7	11.4	11.4
% Dist.	3.6	3.2	3.7	2.4	2.8	2.4	2.2	1.8	2.1	1.6	1.7	1.4
Esig(1)	0.73	0.71	0.67	0.87	0.9	0.9	1.03	1.33	1.14	1.52	1.27	1.56
Eout	7.8	8.1	6.9	9.5	8.6	9.0	14.2	18.3	14.4	19.5	14.5	17.7
Gain	10.7	11.4	10.3	10.9	9.6	10.0	13.8	13.8	12.6	12.8	11.4	11.3
% Dist.	5.0	4.6	4.7	4.7	5.0	4.4	4.8	5.0	5.0	5.0	4.6	4.7

Table T Pentode Section

Rb	Ebb = 100 VOLTS						Ebb = 250 VOLTS					
	0.1		0.27		0.47		0.1		0.27		0.47	
Rc2	0.33		0.82		1.5		0.33		1.0		1.8	
Rcf	0.27	0.47	0.27	0.47	1.0	0.47	1.0	0.27	0.47	0.27	0.47	1.0
Rk	1500	1500	3300	3300	3300	5600	5600	470	470	1200	1200	2200
Ib	.612	.612	.273	.273	.273	.159	.159	1.84	1.84	.69	.69	.69
Ic2	.209	.209	.095	.095	.095	.054	.054	.610	.610	.21	.21	.21
Ec1	-1.23	-1.23	-1.21	-1.21	-1.21	-1.19	-1.19	-1.15	-1.15	-1.08	-1.08	-1.16
Ec2	29.8	29.8	20.9	20.9	20.9	17.8	17.8	50.9	50.9	38.9	38.9	27.5
Eb	37.6	37.6	25.1	25.1	25.1	24.1	24.1	64.9	64.9	62.4	62.4	58.8
Esig	.05	.05	.05	.05	.05	.05	.05	.05	.05	.05	.05	.05
Eout	5.0	5.8	5.2	6.3	7.2	5.85	7.1	10.0	11.0	10.2	12.5	14.4
Gain	100	116	104	126	144	107	142	200	220	204	250	288
% Dist.	2.8	2.6	2.0	1.5	1.5	2.9	2.7	2.2	1.7	2.3	2.2	2.3
Esig(1)	.09	.11	.09	.09	.09	.07	.07	.14	.19	.09	.08	.09
Eout	9.1	12.2	9.1	11.5	13.2	8.15	10.2	26.5	39.5	17.8	19.5	25.4
Gain	101	111	101	128	147	107	146	189	208	198	244	282
% Dist.	4.6	4.9	5.0	5.0	4.6	5.0	5.0	5.0	4.5	4.1	3.4	3.4

Table U

Rb	Ebb = 100 VOLTS						Ebb = 250 VOLTS					
	0.1		0.27		0.47		0.1		0.27		0.47	
Rc2	0.56		1.5		2.7		0.56		1.5		2.7	
Rcf	0.27	0.47	0.27	0.47	1.0	0.27	0.47	0.27	0.47	1.0	0.47	1.0
Rk	1500	1800	3300	3300	3300	5600	5600	820	820	1200	1500	1800
Ib	0.51	0.48	0.23	0.23	0.23	0.13	0.13	1.47	1.47	0.68	0.65	0.65
Ic2	0.10	0.10	0.05	0.05	0.05	0.03	0.03	0.29	0.29	0.13	0.13	0.08
Ec1	-0.92	-1.10	-0.91	-0.91	-0.91	-0.91	-0.91	-1.44	-1.44	-0.97	-1.17	-1.17
Ec2	43	43	24	24	24	18	18	87	87	54	54	33
Eb	48	51	37	37	37	38	38	102	102	66	74	74
Esig	0.05	0.05	0.05	0.05	0.05	0.05	0.05	0.1	0.1	0.1	0.1	0.1
Eout	4.15	4.45	4.95	6.0	7.15	5.9	7.45	11.2	12.5	15.7	18.6	22.0
Gain	83.0	89.0	99.0	120	143	118	149	112	125	157	186	220
% Dist.	1.2	1.5	3.1	2.8	2.1	4.0	3.0	0.6	0.5	0.8	0.6	0.8
Esig(1)	0.12	0.16	0.08	0.09	0.1	0.06	0.08	0.51	0.49	0.21	0.29	0.28
Eout	9.65	13.5	7.6	10.5	13.5	6.95	11.6	51.0	54.5	32.0	48.0	54.5
Gain	80.3	84.4	95.0	116	135	116	145	100	111	152	165	194
% Dist.	3.4	5.0	5.0	4.6	4.2	4.7	5.0	4.2	3.1	2.7	5.0	3.3

Table V

Rb	Ebb = 180 VOLTS						Ebb = 300 VOLTS					
	0.1		0.22		0.47		0.1		0.22		0.47	
Rc2	0.33		0.82		1.8		0.33		0.82		1.2	
Rcf	0.22	0.47	0.22	0.47	1.0	0.47	1.0	0.22	0.47	0.22	0.47	1.0
Rk	680	680	1200	1200	1200	2500	2500	330	330	580	580	1200
Esig	.5	.5	.37	.36	.33	.27	.26	.45	.42	.34	.34	.28
Eout	28	33	24	31	34	27	32	32	35	28	37	41
Gain	56	65	65	87	101	98	122	68	83	81	109	125

Table W

Rb	Ebb = 300 VOLTS						Ebb = 400 VOLTS					
	.022		.047		.10		.022		.047		.10	
Rcf	0.1	0.27	0.1	0.27	0.1	0.27	0.47	0.1	0.27	0.1	0.27	0.47
Rk	820	820	1500	1800	2700	3900	4700	820	820	1500	1800	2700
Ib	7.22	7.22	3.8	3.54	1.94	1.74	1.63	9.75	9.75	5.09	4.8	2.64
Ec1	-5.92	-5.92	-5.7	-6.38	-5.24	-6.88	-7.66	-8.0	-8.0	-7.64	-8.64	-9.3
Eb	135.3	135.3	115.7	127.0	100.8	119.1	129.3	177.5	177.5	155.9	165.7	128.9
Esig	1.0	1.0	1.0	1.0	1.0	1.0	1.0	1.0	1.0	1.0	1.0	1.0
Eout	13.5	13.8	13.4	13.6	13.0	13.0	13.0	13.5	13.8	13.5	13.7	13.3
Gain	13.5	13.8	13.4	13.6	13.0	13.0	13.0	13.5	13.8	13.5	13.7	13.3
% Dist.	1.1	0.9	1.1	0.8	1.2	0.8	0.8	0.8	0.8	0.8	0.7	0.9
Esig	4.19	4.19	4.03	4.51	3.7	4.86	5.42	5.66	5.66	5.4	6.12	5.04
Eout	56.5	58.0	54.0	61.5	48.0	63.0	69.8	76.2	78.2	73.0	83.8	66.5
Gain	13.5	13.8	13.4	13.6	13.0	13.0	12.9	13.5	13.8	13.5	13.7	13.3
% Dist.	4.8	4.4	4.6	4.4	4.8	4.6	4.8	4.9	4.4	4.8	4.5	5.0

Table X

Rb	Ebb = 90 VOLTS			Ebb = 180 VOLTS			Ebb = 300 VOLTS		
	0.1	0.27	0.47	0.1	0.27	0.47	0.1	0.27	0.47
Rc2	0.47	1.5	2.7	0.39	1.2	3.3	0.47	1.5	3.3
Rcf	0.27	0.47	1.0	0.27	0.47	1.0	0.27	0.47	1.0
Rk	1200	2200	4700	1200	1200	2700	390	1000	1000
Esig	.33	.23	.22	.61	.32	.27	.51	.43	.40
Eout	15	15	17	27	28	30	40	45	52
Gain	45	65	77	44	87	110	78	105	134
% Distortion	5	5	5	5	5	5	5	5	5

Table Y

Rb	Ebb = 180 VOLTS						Ebb = 300 VOLTS					
	0.10		0.24		0.51		0.1		0.24		0.51	
Rcf	0.10	0.24	0.24	0.51	0.51	1.0	0.10	0.24	0.24	0.51	0.51	1.0
Rk	2400	2700	4300	4700	7500	8200	1800	2000	3000	3300	5600	6200
Esig	.62	.70	.60	.70	.60	.70	1.0	1.1	1.0	1.0	1.0	1.1
Eout	18	23	24	31	28	35	35	42	43	52	50	60
Gain	29	34	40	45	47	50	33	38	44	49	51	55
% Dist.	5	5	5	5	5	5	5	5	5	5	5	5

Note (1) For Self Bias Operation This is Taken at the Grid Current Point With Less than $\frac{1}{8}\mu\text{a}$. Grid Current.

TUBE TYPE BASING ARRANGEMENTS

BASE	TYPE	BASE	TYPE	BASE	TYPE	BASE	TYPE
OA5	OA5	6AR	1AE4, 1AF4, 1L4, 1T4, 1U4, 5910	7CV	4GZ5, 6AS5, 6CA5, 6CU5, 6EH5, 6GZ5, 11C5, 12AS5, 12C5, 12CA5, 12CN5, 12CU5, 12DM5, 12ED5, 12EH5, 12FX5, 12R5, 17C5, 17CA5, 17CU5, 17R5, 25C5, 25CA5, 25EH5, 25F5, A, 32E5, 34GD5, 35C5, 35EH5, 40FR5, 50C5, 50CA5, 50EH5, 50FA5, 50FK5, 60FX5	8BS	28D7, W, 1238
1AG4	1AG4	6AU	1AF5, 1S5	7DB	6AM6, 7498	8BW	7F8, W, 14F8
1AG5	1AG5	6AX	1LD5	7DC	1L6, 1U6	8BZ	7X7
1AH4	1AH4	6B	41, 42, 43	7DF	3BN6, 4BN6, 6BN6, 12BN6	8CH	6AL7GT
1AJ5	1AJ5	6BA	3D6	7DK	1DY4, A, 2AF4, A, B, 2DX4, 2DY4, A, 2DZ4, 2T4, 3AF4A, B, 3DX4, 3DY4, A, 3DZ4, 5AF4A, 6AF4, A, 6AN4, 6DX4, 6DY4, A, 6DZ4, 6T4, 7R7, 8334	8CJ	2C51, 5670, WA, 7861
1AK4	1AK4	6BG	6C4, 6DR4, 6100, 6135, 6136	7DU	6354	8CK	6AQ7GT
1AK5	1AK5	6BS	2050, A	7DX	7A6, 50X6	8CP	1AC5, 1AD5
1V6	1V6	6BT	3AL5, 6AL5, 6EB5, 12AL5, 5726, 5726/6AL5W/6097, 6097, 6663/6AL5, 6919, 7055, 7631	7EA	6CR6, 12CR6	8CT	6BA7, 12BA7
3C	1AU3, 1B3GT, 1G3, 1J3, 1J3A, 1K3, 1N2A	6BW	1DN5, 1U5	7EG	2BN4, A, 3BN4A, 4BN4, 6BN4A	8DA	1S6
4AA	1LE3, 1293	6BX	3V4	7EJ	7001	8DC	5636, 5908, 5916, 6205, 6206, 6943, 6944, 8414, 8444
4AB	2X2, 2X2A	6CC	6AR5	7EN	3DT6, A, 4DT6, A, 5GX6, 6DT6, A, 6GX6, 6GY6, 6HZ6, 12UT6, 7693, 7694	8DD	5643
4AC	3A3	6CH	6AM5, 6BJ5, 6516	7ES	1AN5	8DF	6AZ5
4AH	1R4	6CJ	5641	7EW	2CY5, 2EA5, 2EV5, 3CY5, 3EA5, 3EV5, 4CY5, 6CY5, 6EA5, 6EV5, 7167, 7717, 8113	8DG	6BF7W, 6021, 6111, 6112, 6832, 6947, 6948, 7327, 7550, 7759, 7760, 7887, 7889, 8103
4AJ	OA3, A, OB3, A, OC3, A, OD3, A, 1265, 1266	6CK	6AU5GT, 6AV5GA, 6BD5GT, 6FW5, 12AV5GA, 17AV5GA, 18A5, 25AV5-GA, 6000	7FB	12EL6	8DJ	5896, 5903, 6052, 6053, 6110
4AM	2C22	6CL	5851, 6147	7FD	12K5	8DK	6AD4, 6AK4, 5718, 5719, 5904, 5977, 6055, 6814, 6946, 7888
4BU	OY4, OY4G	6CN	6BY5G, GA	7FL	2EN5	8DL	5639, 5840, 5899, 5902, 5905, 5906, 5907, 6049, 6056, 6788, 6945, 7761, 7762, 8064, 8211
4C	5Z3, 80, 83, 1275	6E	25Z5	7FP	2ER5, 2ES5, 2FH5, 2FO5, A, 2FY5, 2GK5, 3ER5, 3ES5, 3FH5, 3FO5, A, 3FY5, 3GK5, 4GK5, 6ER5, 6ES5, 6FH5, 6FQ5, A, 6FY5, 6GK5, 6ER5	8DM	5987
4CG	6AU4GTA, 6AX4GT, GTA, 6CQ4, 6DA4, A, 6DE4, 6DM4, A, 6DO4, 6DT4, 6W4GT, GTA, 12AX4GT, GTA, GTB, 12D4, A, 12DM4, A, 12DQ4, 17AX4GT, GTA, 17D4, A, 17DE4, 17DM4, A, 17DQ4, 19AU4, GTA, 22DE4, 25AX4GT, 25W4GT	6F	6C6, 6D6, 78, 1221	7FQ	2FV6, 6FV6	8DQ	5968
4CK	5823	6G	75	7FW	6GN6, 12GN6	8DR	5969
4CN	5644	6HQ6	6HQ6	7GA	2FS5, 2GU5, 3FS5, 3GU5, 6FG5, 6FS5, 6GU5	8DS	5970
4D	2A3, 6A3, 45, 1230, 1276	6Q	6AC5GT, 6C5, GT, 6J5, GT, 12J5GT, 884	7GK	2GW5, 3GW5, 4GW5, 6GW5	8DY	6BA5
4K	1229	6R	6E5, 6U5	7GM	2HA5, 2HK5, 2HM5, 3HA5, 3HK5, 3HM5, 4HA5, 4HK5, 4HM5, 6HA5, 6HK5, 6HM5	8E	6B8, 12C8
4R	OZ4, OZ4A, OZ4G	6S	6AX5GT, 6X5GT, WGT, 1274	7Q	6H6, GT, 12H6, 25Z6GT, 50AX6G, 50Y6GT, 117Z6GT	8EC	7212, 7358
4V	OA4G, 1267	6X	1A5GT	7R	6J7, G, GT, 6K7, 12J7GT, 12K7GT, 1223	8EL	6AH4GT
4Z	35Z3	7AC	6550	7S	5V6GT, 6DG6GT, 6EY6, 6EZ5, 6EZ6, 6F6, G, GT, 6G6G, GT, 6K6GT, 6L6, GB, GC, 6U6GT, GTY, 6V6, GT, GTA, 6W6GT, 6Y6GA, 7EY6, 9EF6, 12A6, 12EF6, 12EN6, 12L6GT, 12V6GT, 12W6GT, 17L6GT, 25L6GT, 25W6GT, 35L6-GT, 50L6GT, 1614, 5824, 5871, 5881, 5932, 7408, EL-37, KT-66, KT-88, 7581, A, 7751, 8417	8ES	40A1, 40B2
5AB	7Y4, 7Z4	7AG	6AD6G, 6AF6G	7T	6L7, 6P7G, 1612	8ET	6CA7, EL34/6CA7
5AC	7A4/XXL, 7B4	7AK	1LA6, 1LC6	7V	6Q7, GT, 6R7, 12Q7GT, 6118	8EX	6308
5AD	1LA4, 1LB4	7AO	1LC5, 1LG5, 1LN5	7Z	1A7GT	8EY	6352
5AG	1LH4	7AP	3Q5GT	8A	6AB, G, GT, 12A8GT	8EZ	3AW3
5AL	35Y4	7AT	1R5	8AC	7AF7, 7F7, 7N7, 14AF7/XXD, 14F7	8FP	6BU5
5AP	1A3	7AV	1S4	8AD	6SA7GT, GTY, 12SA7GT	8FU	6BD4, A
5AW	807, W, 5933, WA	7AZ	6SF7, 12SF7	8AE	7R7, 14R7	8G	6C8G, 6F8G
5AY	6D4	7BA	3S4, 3Q4, 3Z4	8AL	7Q7, 14Q7	8GB	6BL4
5AZ	1625	7BB	3A4	8AN	50Y7GT	8GC	6BK4, A, 6BU4
5BO	OA2, WA, OB2, WA, OC2, 5651, WA, 6626, 6627	7BC	3A5	8AO	117L7/M7GT	8GD	6CB5A, 6CL5, 6FN5
5BQ	25DK4, 35W4, 36AM3, A, 50DC4	7BD	3CE5, 3BC5, 4BC5, 4CE5, 6AG5, 6AJ5, 6AK5, 6AN5, 6BC5, 6CE5, 35C5, 408A, 5654, 5654/6AK5W/6096, 6028, 6186, 6186/6AG5WA, 6968, 9001, 9003	7BE	3B7	8GH	3B2
5BS	6X4, WA, 12X4	7BF	5J6, 6J6, A, WA, 19J6, 1216, 5844, 5964, 6045, 6099, 6101, 7244, A	7BF	5J6, 6J6, A, WA, 19J6, 1216, 5844, 5964, 6045, 6099, 6101, 7244, A	8GQ	6690
5BT	6BG6GA, 6CD6G, GA, 6DN6, 6EX6, 19BG6G, GA, 21EX6, GA, GB, 25CD6GB, 25DN6, 25EC6, 35CD6-GA, 7867	7BH	2C21	7BH	2C21	8GT	6CM5
5CA	5845	7BJ	6AN6	7BJ	6AN6	8GV	6M3
5CB	5722	7BK	3AU6, 3BA6, 4AU6, 4BA6, 6AH6, 6AK6, 6AU6, A, WB, 6BA6, 6BD6, 6FD6, 6HR6, 6HS6, 12AC6, 12AF6, 12AU6, 12BA6, 12BD6, 12BL6, 12CX6, 12CY6, 12DZ6, 12EA6, 12EK6, 12EZ6, 18FW6, 18GD6, 19HR6, 19HS6, 5749, 5749/6BA6W, 6660/6BA6, 7496, 7543, 8425, 8426	7BK	3AU6, 3BA6, 4AU6, 4BA6, 6AH6, 6AK6, 6AU6, A, WB, 6BA6, 6BD6, 6FD6, 6HR6, 6HS6, 12AC6, 12AF6, 12AU6, 12BA6, 12BD6, 12BL6, 12CX6, 12CY6, 12DZ6, 12EA6, 12EK6, 12EZ6, 18FW6, 18GD6, 19HR6, 19HS6, 5749, 5749/6BA6W, 6660/6BA6, 7496, 7543, 8425, 8426	7BK	3AU6, 3BA6, 4AU6, 4BA6, 6AH6, 6AK6, 6AU6, A, WB, 6BA6, 6BD6, 6FD6, 6HR6, 6HS6, 12AC6, 12AF6, 12AU6, 12BA6, 12BD6, 12BL6, 12CX6, 12CY6, 12DZ6, 12EA6, 12EK6, 12EZ6, 18FW6, 18GD6, 19HR6, 19HS6, 5749, 5749/6BA6W, 6660/6BA6, 7496, 7543, 8425, 8426
5CE	6AB4, 6664	7BN	2D21	7BN	2D21	8HC	2B3
5D	6Z4/84, 84/6Z4	7BQ	6J4, WA, 7137, 7245	7BQ	6J4, WA, 7137, 7245	8HE	6853
5DE	3DG4	7BS	9002	7BS	9002	8HY	7027, A
5L	5AR4, 5AT4, 5CG4, 5V4G, GA, 5Z4, GT, GZ34	7BT	3AV6, 4AV6, 4AY6, 6AT6, 6AQ6, 6AV6, 6BF6, 12AE6, A, 12AJ6, 12AT6, 12AV6, 12BF6, 12BK6, 12FK6, 12FM6, 12FT6, 18FY6, 18GE6	7BT	3AV6, 4AV6, 4AY6, 6AT6, 6AQ6, 6AV6, 6BF6, 12AE6, A, 12AJ6, 12AT6, 12AV6, 12BF6, 12BK6, 12FK6, 12FM6, 12FT6, 18FY6, 18GE6	7BT	3AV6, 4AV6, 4AY6, 6AT6, 6AQ6, 6AV6, 6BF6, 12AE6, A, 12AJ6, 12AT6, 12AV6, 12BF6, 12BK6, 12FK6, 12FM6, 12FT6, 18FY6, 18GE6
5M	6F5, GT, 12F5GT	7BZ	5AQ5, 6AQ5, A, 6BF5, 6DS5, 12AQ5, 19AQ5, 35B5, 50B5, 6005, 6005/6AQ5W/6095, 6095, 6096, 6669/6AQ5	7BZ	5AQ5, 6AQ5, A, 6BF5, 6DS5, 12AQ5, 19AQ5, 35B5, 50B5, 6005, 6005/6AQ5W/6095, 6095, 6096, 6669/6AQ5	7BZ	5AQ5, 6AQ5, A, 6BF5, 6DS5, 12AQ5, 19AQ5, 35B5, 50B5, 6005, 6005/6AQ5W/6095, 6095, 6096, 6669/6AQ5
5Q	5X4GA, 5Y4GA, GT	7C	6A7	7C	6A7	8JB	6CK4
5S	6B4G	7CH	3BE6, 3BY6, 3CS6, 4BE6, 4CS6, 6BE6, 6BY6, 6CS6, 12AB6, 12AD6, 12AG6, 12BE6, 12CS6, 12EG6, 12FA6, 18FX6, 1217, 5750/6BE6W, 5750, 5915, A, 7032, 7036, 7502	7CH	3BE6, 3BY6, 3CS6, 4BE6, 4CS6, 6BE6, 6BY6, 6CS6, 12AB6, 12AD6, 12AG6, 12BE6, 12CS6, 12EG6, 12FA6, 18FX6, 1217, 5750/6BE6W, 5750, 5915, A, 7032, 7036, 7502	7CH	3BE6, 3BY6, 3CS6, 4BE6, 4CS6, 6BE6, 6BY6, 6CS6, 12AB6, 12AD6, 12AG6, 12BE6, 12CS6, 12EG6, 12FA6, 18FX6, 1217, 5750/6BE6W, 5750, 5915, A, 7032, 7036, 7502
5T	5AS4, A, 5AU4, 5AW4, 5AX4GT, 5AZ4, 5R4GY, GYA, GYB, 5T4, 5U4G, GA, GB, 5U4WG, 5V3, A, 5Y3GT, GTA, WGTA, 5931	7CK	2E26, 6146, 6883, 6888, 6893	7CK	2E26, 6146, 6883, 6888, 6893	8JC	6DQ5
5Y	1N5GT	7CM	3BZ6, 3CB6, 3CF6, 3DK6, 4BZ6, 4CB6, 4DE6, 4DK6, 4EW6, 4GM6, 4JK6, 4JL6, 5EW6, 5GM6, 5JK6, 5JL6, 6AS6, 6BH6, 6BJ6, 6BZ6, 6CB6A, 6CF6, 6DB6, 6DC6, 6DE6, 6DK6, 6EW6, 6GM6, 6JH6, 6JK6, 6JL6, 12AW6, 12BZ6, 12DK6, 15EW6, 5725, 5725/6AS6W, 6661/6BH6, 6662/6BJ6, 6676, 6954, 7056, 7732, 8084, 8136	7CM	3BZ6, 3CB6, 3CF6, 3DK6, 4BZ6, 4CB6, 4DE6, 4DK6, 4EW6, 4GM6, 4JK6, 4JL6, 5EW6, 5GM6, 5JK6, 5JL6, 6AS6, 6BH6, 6BJ6, 6BZ6, 6CB6A, 6CF6, 6DB6, 6DC6, 6DE6, 6DK6, 6EW6, 6GM6, 6JH6, 6JK6, 6JL6, 12AW6, 12BZ6, 12DK6, 15EW6, 5725, 5725/6AS6W, 6661/6BH6, 6662/6BJ6, 6676, 6954, 7056, 7732, 8084, 8136	7CM	3BZ6, 3CB6, 3CF6, 3DK6, 4BZ6, 4CB6, 4DE6, 4DK6, 4EW6, 4GM6, 4JK6, 4JL6, 5EW6, 5GM6, 5JK6, 5JL6, 6AS6, 6BH6, 6BJ6, 6BZ6, 6CB6A, 6CF6, 6DB6, 6DC6, 6DE6, 6DK6, 6EW6, 6GM6, 6JH6, 6JK6, 6JL6, 12AW6, 12BZ6, 12DK6, 15EW6, 5725, 5725/6AS6W, 6661/6BH6, 6662/6BJ6, 6676, 6954, 7056, 7732, 8084, 8136
5Z	1H5GT					8JD	5CU4
6AA	7A5, 7C5, 14C5, 35A5, 50A5					8KE	6K8, 12K8
6AB	6SF5, 12SF5, 12F5GT					8KB	6FE5, 50FE5
6AB8	6AB8					8KD	5CU4
6AD	35Z5GT					8KG	7591, A
6AE	7B5					8KM	7994, 8185, 8186
6AM	6AL6, 6BQ6GTA, GTB, 6BW5, 6CU6, 6DJ6, 6DQ6A, B, 6GW6, 12BQ6GTA, GTB, 12CU6, 12DQ6A, B, 12GW6, 17BQ6GTA, 17DQ6A, B, 17GW6, 25BQ6GA, GT, GTB, 25DQ6A					8KN	7355
						8KS	5DJ4
						8KZ	7995
						8LC	8068
						8LD	8070, 8319
						8LE	8071
						8LK	3F X7, 6F X7
						8LM	3FW7, 6FW7
						8LS	8210
						8LT	8213
						8LW	8254
						8N	6AB7, 6AC7, 6SJT, GT, WGT, 6SK7, GT, 6SS7, 12SJ7, GT, 12SK7, GT, 5693
						8Q	6SQ7, GT, 6SR7, 12SQ7, GT, 12SR7
						8R	6SA7, 6SB7Y, 12SA7
						8S	6SC7, 12SC7
						8U	7A8

TUBE TYPE BASING ARRANGEMENTS

BASE	TYPE	BASE	TYPE	BASE	TYPE	BASE	TYPE
8V	7A7, 7AG7, 7AK7, 7B7, 7C7, 7H7, 7L7, 7V7, 14A7, 14C7, 1231, 1273, 1280, 1284, 6145	9EN	6CN7, 8CN7	9LG	6CY7, 8CY7, 11CY7	12BU	6AL11, 6G11, 10AL11, 12AL11, 12G11
8W	7B6, 7C6, 14B6	9EP	7898	9LP	6EV7, 6FQ7, 6GU7, 8FQ7	12BW	6J11
8X	7B8	9EQ	7721, 7722	9LQ	6EQ7, 6KL8, 12EQ7, 12KL8, 20EQ7	12BY	6K11, 6Q11, 6AV11
8Y	6AG7	9ER	6BJ8, 6BN8, 8BN8	9LS	6EU7	12CA	6M11
9A	6AX7, 7AU7, 9AU7, 12AD7, 12AE7, 12AT7, WA, 12AU7, A, 12AV7, 12AX7, A, 12AY7, 12AZ7A, 12BH7, A, 12BZ7, 12DF7, 12DM7, 12DT7, 12DW7, 12FV7, 12U7, 5751, WA, 5814, A, WA, 5963, 5965A, 6189, 6189/12AU7WA, 6201, 6211A, 6679/12AT7, 6680/12AU7, 6681/12AX7, 6851, 6955, 7025A, 7058, 7062, 7316, 7318, 7489, 7490, 7492, 7494, 7728, 7729, 7730	9ES	6CM7, 8CM7	9LT	6ET7, 6KU8, 8ET7, 10KU8	12CN	7984
9AC	6S4A	9EU	6GC5, 12AB5, 6973, 7061	9LW	3GS8, 3HS8, 4GS8, 4HS8, 6GS8, 6HS8	12CT	8058
9AD	5879	9EX	6A8, 6BM8, 6DZ8, 6HC8, 8DZ8, 9DZ8, 12DZ8, 17HC8, 18DZ8, 50BM8, 35DZ8, 50FY8	9LX	1H2	12DA	6AG11, 6AY11, 30AG11
9AE	5EA8, 5GH8, 5KD8, 5U8, 6AX8, 6EA8, 6GH8, A, 6GJ8, 6HL8, 6KD8, 6U8A, 9EA8, 9U8A, 19EA8, 6678/6U8, 7059, 7643, 7687, 7731, 8445	9FA	5BR8, 5FV8, 6BR8A, 6FV8, A, 6JN8, 9BR8, 12EC8, 12JN8, 19HV8, 8446	9LY	6GV8, 8GV8, 9GV8, 19KG8	12DE8	12DE8
9AG	12B4A	9FC	4CX7, 6CH7, 6CX7	9LZ	6GW8	12DG	2AH2
9AH	6V8, 19V8, 7500	9FE	5BT8, 6BT8	9M	6CA4	12DM	6AR11, 11AR11
9AJ	4BC8, 4BQ7A, 4BS8, 4BX8, 4BZ7, 4BZ8, 4ES8, 4KN8, 5BK7A, 5BQ7A, 5BZ7, 5ES8, 6AO8, 6BC8, 6BK7A, B, 6BQ7A, 6BS8, 6BX8, 6BZ7, 6BZ8, 6CG7, 6GM8, 6DJ8, 6DT8, 6ES8, 6FW8, 6JK8, 6KN8, 7DJ8, 7ES8, 8CG7, 8JK8, 12DJ8, 12DT8, 17JK8, 6922, 7057, 7803, 8223, 8431	9FH	12F8	9ME	18HB8, 35HB8	12DP	6AS11, 6AF11, 6BD11, 15AF11, 15BD11
9AK	5X8, 6X8, 9X8, 19X8	9FJ	6BV8	9MP	4HG8, 5HG8, 6GY8, 6HG8, 7HG8, 8HG8	12DQ	1AD2
9AQ	3BX6, 3BY7, 3EH7, 3EJ7, 4EH7, 4EJ7, 6BX6, 6EH7, 6EJ7, 6EL7, 6GK7, 12BX6, 13EC7	9FK	17H3	9MQ	6GM5	12DR	6GV5, 6GY5, 16GY5, 17GV5, 21GY5
9AX	6BC7, 6BJ7	9FN	6BY8	9MR	6FA7	12DT	8149
9AZ	12AD5	9FR	7233	9MS	7701	12DU	8150
9BA	7227, 7499, 6DG7	9FT	6CH8	9MX	7719	12DZ	6JZ8, 17JZ8
9BD	6B3, 6V3A, 12B3	9FV	6854	9MZ	7737	12EA	2DV4, 6DV4
9BF	12BV7, 12BY7, 12DQ7, 12GN7, 6870, 7054, 7733, 8448	9FX	5CL8, A, 6CL8A, 9CL8, 19CL8A	9NF	7763	12EB	6GA7
9BJ	2HR8, 4HR8	9FZ	5CM8, 6CM8, 6CS8, 6KZ8, 9KZ8	9NQ	6HW8	12EJ	6FM7, 13FM7, 15FM7
9BQ	6BK5, 12BK5, 25BK5, 50BK5	9G	5686	9NX	6BF8	12EL	1AJ2
9BS	12DF5	9GA	6HU6	9NZ	6GT5, 12GT5, 17GT5, 7868	12EN	56R9
9BV	6CL6, 6677/6CL6	9GB	6877	9PA	6JC8	12EO	6FY7, 15FY7
9BX	6AJ4, 6AM4, 6CR4	9GC	12J8	9PB	7905	12ER	6BA11
9CB	6AF3, 6BR3, 12AF3, 12BR3, 17BR3, 25BR3	9GE	5CQ8, 6CQ8	9PG	4KF8, 20EZ7	12ES	6HD5, 6HJ5, 21HD5, 21HJ5, 28HD5, 30HD5, 30HJ5
9CF	9BR7, 12BR7, 8447	9GF	5CG8, 5FG7, 6CG8, A, 6FG7, 6GD7, 9CG8A	9PJ	8106	12EU	8156
9CK	5CM6, 6CM6, 6DW5, 12CM6, 12DW5	9GJ	5CR8, 6CR8	9PL	8106	12EW	2AS2
9CM	50A1	9GK	6GK6, 16GK6	9PM	3HM6, 3HT6, 3JC6, 3JD6, 4HM6, 4HT6, 4JC6, 4JD6, 6HM6, 6HT6, 6JC6, 6JD6	12EX	3AT2
9CQ	EF86/6267	9GM	6CU8	9PQ	6JU8	12EY	6HE5
9CV	6BQ5, 6CW5, 6DY5, 8BQ5, 8CW5, 10BQ5, 12FB5, 15CW5, EL84/6BQ5, EL86, 30CW5, 7189, 7320	9GR	6DB5, 12DB5	9PX	7695, 7754	12EZ	6BF11, 6T10, 17BF11
9CY	5AM8, 6AM8, A, 6HJ8	9GS	12AL8	9PU	6HB6, 15HB6	12FB	6HF5
9CZ	12G8, 6350, 6463, 6840	9GT	12DK5	9PV	6KA8, 8KA8	12FC	33GT7
9DA	5AN8, 6AN8, A, 10C8, 12CT8, 7258, 7492, 8489	9H	5687, 6900, 7044, 7119, 7370	9PY	8212	12FE	6U10
9DC	4BL8, 5KE8, 6BL8, 6KE8, 8A8, 9A8	9HE	6DC8	9PZ	8233	12FM	6T9
9DD	6FC7, 7FC7	9HF	6DE7, 6DR7, 6EW7, 6FD7, 6FR7, 10DE7, 10DR7, 10EW7, 10FD7, 10FR7, 13DE7, 13DR7, 13FD7, 13FR7, 19DE7, 19EW7	9QA	6GJ7	12FN	33GY7
9DJ	6BW4, 12BW4	9HK	5BW8, 6BW8	9QB	8278	12FQ	4HA7
9DS	5AS8, 6AS8	9HL	6939	9QD	6GF7, 10GF7, 13GF7	60E3	60E3
9DT	3A2	9HN	5CZ5, 6CZ5, 6DT5, 6EM5, 6GB5, 8EM5, 12DT5, 13GB5, 25DT5, 27GB5, 28GB5	9QE	6JA8, 10JA8	407A	407A
9DV	6486A	9HP	6AY3, A, 6BA3, 6BH3, 6BS3, 6DW4, 12AY3, 12BS3, 17AY3, 17BH3, 17BS3, 22BH3	9QF	6KJ8	FM1000	FM1000
9DW	5AT8, 6AT8, A	9HR	12DL8, 12DV8	9QG	6KM8	1222	1222A
9DX	6AU8, A, 6AW8, A, 6BA8, A, 6BH8, 6CX8, 6EB8, 6GN8, 6HF8, 6HZ8, 6JE8, 6JL8, 6JT8, 6JV8, 6KR8, 6KS8, 6KV8, 6LB8, 8AU8, A, 8AW8A, 8BA8A, 8BH8, 8CX8, 8EB8, 8GN8, 8JE8, 8JL8, 8JT8, 8JV8, 8KS8, 10EB8, 10HF8, 10JT8, 10JV8, 10LB8, 11JE8, 11KV8, 7060, 7716	9HV	12EM6	9QH	6KQ8	1236A	1236A
9DZ	5AV8	9HX	6DX8, 10DX8	9QJ	5BC3	1247	1247
9E	5T8, 6T8A, 19C8, 19T8	9HZ	12DK7	9QK	6GJ5, 12GJ5, 17GJ5	5642	5642
9EC	5B8	9JC	12DW8	9QL	6JB6, 6JE6, 12JB6, 17JB6	5647	5647
9ED	6AZ8	9JF	5EU8, 6EU8	9QM	6GQ7, 19GQ7	5702	5702, WA, WB
9EF	6CS7, 8CS7, 6DA7, 10DA7	9JG	5EH8, 6EH8	9QN	6KT8	5703	5703, WA, WB
9EG	5BE8, 5DH8, 6BE8, A	9JH	7150	9QP	6KT8	5704	5704
9EJ	6582A, 7001	9JT	7199	9QR	8358	5744	5744
		9JU	12DS7, A	9QT	15KY8, 17LD8	5783	5783, 5787
		9JX	12DU7	9QU	22JG6	5784	5784
		9JY	12DV7	9QY	6LC8, 8LC8	5785	5785
		9K	7495	9T	17C8	5889	5889
		9KA	6EZ8, 19EZ8	9U	1AU2, 1AU4, 1V2	6098	6098
		9KG	4CM4, 6CM4	9V	417A, 5842	6187	6187
		9KH	7239	9X	5847	6418	6418
		9KN	6GV7, 7GV7	9Y	1AX2, 1X2B	6483	6483
		9KP	6FH8	10F	6C9, 17C9A	6611	6611
		9KR	6FM8, 14GT8, 14JG8, 7724	10G	6J9	6612	6612
		9KS	7360	10H	19Q9	6763	6763
		9KT	12FQ8	12AQ	2CW4, 2DS4, 6CW4, 13CW4, 7586, 8056, 8382, 8441, 8456	6872	6872
		9KU	12FR8	12AS	7587, 8380	7077	7077
		9KV	12FX8, A	12BA	7688, 7689, 7690	7241	7241, 7242
		9LC	6GE8, 7734	12BF	6B10, 8B10	7246	7246
				12BJ	6GE5, 6GF5, 6HB5, 12GE5, 17GE5, 21HB5	7382	7382
				12BL	6AX3, 6BE3, 6BJ3, 12AX3, 12BE3, 12BJ3, 17AX3, 17BE3	7430	7430
				12BM	6FJ7	7561	7561
				12BQ	6C10, 6D10	7576	7576
				12BR	5AZ3	7720	7720
				12BT	6J10, 13J10	7768	7768
						7841	7841

EUROPEAN--AMERICAN RECEIVING TUBE REPLACEMENT CHART

AMERICAN SUBSTITUTIONS FOR EUROPEAN TUBES

EUROPEAN/AMERICAN EXACT REPLACEMENTS
FOR EUROPEAN TUBES

European Type	American Type	Code*	European Type	American Type	Code*
1C1	1R5	ER	EF93	6BA6	ER
1D13	1A3	ER	EF94	6AU6	ER
1F2	1L4	ER	EF95	6AK5	ER
1F3	1T4	ER	EF96	6AG5	ER
1FD9	1S5	ER	EF183	6EH7	ER
1P10	3S4	ER	EF184	6EJ7	ER
1P11	3V4	ER	EH90	6CS6	ER
6D2	6AL5	ER	EK32	6A8/G/GT	NR†
6L12	6AQ8	ER	EK90	6BE6	ER
6P15	6BQ5	ER	EL37	6L6GC	NR†
8D4	6W7	NR†	EL84	6BQ5	ER
9BR8	9U8A	NR†	EL86	6CW5	ER
13D2	6SN7GTB	ER	EL90	6AQ5	ER
B36	12SN7GTA	ER	EL91	6AM5	ER
B65	6SN7GTB	ER	EL180	12BY7A	ER
B152	12AT7	ER	EZ35	6X5GT	ER
B309	12AT7	ER	EZ81	6CA4	ER
B329	12AU7	ER	EZ90	6X4	ER
B339	12AX7, 7025	ER	GZ30	5Z4	ER
B719	6AQ8	NR†	GZ32	5V4GA	ER
BPMO4	6AQ5	ER	GZ33	5U4GB	NR†
D2M9	6AL5	ER	GZ34	5U4GB	NR†
D63	6H6	NR†	H63	6F5/GT	ER
D77	6AL5	ER	HAA91	12AL5	ER
D152	6AL5	ER	HABC80	19T8	ER
DA90	1A3	ER	HBC90	12AT6	ER
DAC32	1H5GT	ER	HBC91	12AV6	ER
DAF91	1S5	ER	HD14	1H5GT	ER
DAF92	1U5	ER	HD30	3B4	ER
DCC90	3A5	ER	HF93	12BA6	ER
DD6	6AL5	NR†	HF94	12AU6	ER
DF33	1N5GT	ER	HK90	12BE6	ER
DF62	1AD4	ER	HL90	19AQ5	ER
DF91	1T4	ER	HL92	50C5	ER
DF92	1L4	ER	HMO4	6BE6	ER
DF904	1U4	ER	HY90	35W4	ER
DH63 (M)	6Q7/G/GT	ER	KT32	25L6GT	NR†
DH76	12Q7/GT	NR†	KT63	6F6G	ER
DH77	6AT6	NR†	KT66	6L6GC, 5881, 807*	NR†
DH81	7B6	NR†	KT71	50L6GT	NR†
DH149	7C6	ER	KTW61	6S7	NR†
DH719	6T8A	ER	KTW63	6K7/G/GT	NR†
DK32	1A7GT	ER	KTZ63	6J7/GT	NR†
DK91	1R5	ER	L63	6J5/GT	ER
DL29	3D6	ER	L77	6C4	ER
DL33	3Q5GT	ER	N14	1C5GT	ER
DL35	1C5GT	ER	N16	3Q5GT	ER
DL36	1Q5GT	ER	N17	3S4	ER
DL91	1S4	ER	N18	3Q4	ER
DL92	3S4	ER	N19	3V4	ER
DL93	3A4	ER	N77	6AL5	NR†
DL94	3V4	ER	N709	6BQ5	ER
DL95	3Q4	ER	N727	6AQ5	ER
DL98	3B4	ER	PCF82	9U8A	ER
DP61	6AK5	ER	PMO4	6BA6	ER
DY30	1B3GT	NR†	PMO5	6AK5	NR*
DY80	1X2B	NR†	QEO6/50	807	NR†
DY86	1H2	NR†	QVO5/25	807	NR†
DY87	1H2	NR†	R19	1X2B	NR†
E90F	6BH6	ER	R52	5Z4	ER
E91H	6BY6	NR†	T2MO5	6J6	ER
EAA91	6AL5	ER	U41	1B3GT	NR†
EABC80	6T8	ER	U50	5Y3GT	ER
EB34	6H6	NR†	U52	5U4GB	ER
EB91	6AL5	ER	U70	6X5GT	NR†
EBC33	6R7	NR†	U78	6X4	ER
EBC90	6AT6	NR†	U147	6X5GT	ER
EBC91	6AV6	ER	U149	7Y4	ER
EBF32	6B8	NR†	U709	6CA4	NR†
EC84	6AJ4	ER	V2M70	6X4	ER
EC90	6C4	ER	W17	1T4	ER
EC92	6AB4	ER	W63	6K7/G/GT	NR†
EC94	6AF4, 6AF4A	ER	W76	12K7/GT	NR†
EC95	6ER5	ER	W149	7B7	ER
EC97	6FQ5A	NR†	W727	6BA6	ER
ECC35	6SL7GT	NR†	X14	1A7GT	ER
ECC40	6N7/GT	NR†	X17	1R5	ER
ECC81	12AT7	ER	X63 (M)	6A8/G/GT	NR†
ECC82	12AU7	ER	X81	7S7	NR†
ECC83	12AX7, 7025	ER	X148	7S7	ER
ECC84	6BQ7A	NR*	X727	6BE6	ER
ECC85	6AQ8	ER	XC95	2ER5	ER
ECC88	6DJ8	ER	XCC189	4ES8	ER
ECC91	6J6	ER	XL84	8BQ5	ER
ECC180	6BQ7A	ER	XF183	3EH7	ER
ECC189	6ES8	ER	XF184	3EJ7	ER
ECF82	6U8	ER	YF183	4EH7	ER
ED2	6AL5	ER	YF184	4EJ7	ER
EF37, EF37A	6J7/GT	NR†	Z14	1N5GT	ER
EF39	6K7/G/GT	NR†	Z63	6J7/GT	ER
			ZD17	1S5	ER

European Type	**European/ American	European Type	**European/ American	European Type	**European/ American
1C2	1AC6	EC97	6FY5	N359	21A6
1FD1	1AH5	ECC84	6CW7	PABC80	9AK8
1P1	3C4	ECC86	6CM8	PC86	4CM4
6F12	6AM6	ECC88	6DJ8	PCC84	7AN7
		ECC89	6FC7	PCC85	9AQ8
6F18	6EC7	ECC189	6ES8	PCC88	7DJ8
6L34	6AQ4	ECF80	6BL8	PCC89	7FC7
6LD3	6CV7	ECF86	6HG8	PCF80	9A8
6P9	6BM5	ECH42	6C9	PCF86	7HG8
7D9	6AM5	ECH80	6AN7	PCL82	16A8
7D10	6CH6	ECH81	6AJ8	PCL84	15DQ8
8D3	6AM6	ECH83	6D58	PL36	25E5
8D5	6BR7	ECL80	6AB8	PL81	21A6
8D7	6BS7	ECL82	6BM8	PL82	16A5
9D6	6CQ6	ECL84	6DX8	PL83	15A6
9P9	9BM5	EF41	6CJ5	PL84	15CW5
17N8	17C8	EF80	6BX6	PMO7	6AM6
19D8	19AJ8	EF81	6BH5	PY80	19X3
19U3	19X3	EF85	6BY7	PY81	17Z3
30C1	8A8	EF86	6CF8	PY82	19Y3
30F5	7ED7	EF86	6267	R16	1T2
30L1	7AN7	EF89	6DA6	SP6	6AM6
30P4	25GF6	EF89F	6DC7	U37	1T2
30P12	12FB5	EF91	6AM6	U43	6X2
62DDT	6CV7	EF92	6CG6	U145	31A3
62VP	6CJ5	EL34	6CA7	U150	6BT4
63T1	6AB8	EL36	6CM5	U151	6X2
64SPT	6BX6	EL38	6CN6	U153	17Z3
65ME	6BR5	EL41	6CK5	U154	19Y3
66KU	6BT4	EL80	6M5	U191	19CS4
67PT	6CK5	EL81	6CJ6	UABC80	28AK8
141TH	14K7	EL83	6CK6	UAF42	12S7
171DDP	17N8	EL85	6BN5	UBC41	14L7
311SU	31A3	EL86	6CW5	UBF80	17N8, 17C8
451PT	45A5	EL91	6AM5	UC92	9AB4
B319	7AN7	EL95	6DL5	UCC85	26AQ8
BF61	6CK5	EL821	6CH6	UCH42	14K7
DAF96	1AH5	EQ80	6BE7	UCH81	19AJ8, 19D8
DC80	1E3	EY51	6X2	UCL82	50BM8
DF96	1AJ4	EY80	6U3	UF41	12AC5
DF97	1AN5	EY81	6R3	UF89	12DA6
DH150	6CV7	EY82	6N3	UL41	45A5
DH719	6AK8	EY86	6S2	UL84	45B5
DK92	1AC6	EY87	6S2A	UQ80	12BE7
DK96	1AB6	EY88	6AL3	UY41	31A3
DL96	3C4	EZ40	6BT4	UY85	38A3
EABC80	6AK8	EZ80	6V4	V61	6BT4
EA42	6CT7	EZ91	6AV4	V6	6CQ6
EBC41	6CV7	GZ34	5AR4	WD142	12S7
EBC80	6BD7	HCH81	12AJ8	WD709	6N8
EBC81	6BD7A	HL94	30A5	X18	1AC6
EBF80	6N8	LN152	6AB8	X20	1AC6
EBF81	6AD8	N78	6BJ5	X79	6AE8
EBF83	6DR8	N142	45A5	X719	6AJ8
EBF89	6DC8	N144	6AM5	Z77	6AM6
EC80	6Q4	N150	6CK5	Z152	6BX6
EC81	6R4	N152	21A6	Z719	6BX6
EC86	6CM4	N153	15A6	Z729	EF86
EC91	6AQ4	N309	15A6	ZD152	6N8
EC93	6BS4	N329	16A5		

*—Basing Differs. †—Heater Characteristics Differ. ‡—Electrical Characteristics Differ.

**—The suggested replacements are principally European manufactured tubes imported for sale in this country.

— ER—Exact Replacement.
NR—Near Replacement.

Types coded NR may require changes in circuit wiring due to differences in basing and electrical characteristics as indicated by the accompanying qualifying notes. Suggested replacements coded ER compare identically with listed European types with respect to electrical characteristics, the type bases used and basing connections. The maximum ratings of suggested replacements compare with those of the European tubes; however, the differences between some types may be of significance in certain applications. Some types may also be especially controlled for particular characteristics.

The data shown is believed to be accurate. However, Sylvania does not assume responsibility in case of error.

Please note that all types listed may not be available from Sylvania. Consult your current price list.

Complete Technical Information and Literature

This is only a partial listing of technical data and brochures available from Sylvania. Additional information may be obtained from your Sylvania Distributor, or writing Sylvania.

SYLVANIA NEWS (ET-1012)—Largest and most widely read publication of its kind in the industry. Published quarterly, the "News" has two 4-page sections — one *Technical*; the other *Dealer*. An editorial content devoted to the service technician keeps him abreast of the latest developments in our industry. Dealer Section includes new product information, feature stories on merchandising, servicing and sales promotion. **Subscription—Free!**

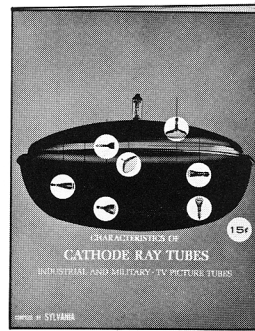

CHARACTERISTICS OF CATHODE RAY TUBES (ET-1351)—Detailed characteristics data for hundreds of CRT types — industrial and military, and TV picture tubes. Includes basing diagrams and phosphor chart. An invaluable reference for dealers and technicians. **Price—15¢.**

SYLVANIA INDUSTRIAL NEWS (ET-2004) — Keep up-to-date on Sylvania's latest industrial products, equipment operation and maintenance with Sylvania Industrial News. Every service dealer with industrial accounts should find it indispensable. Published 6 times a year. **Subscription—Free!**

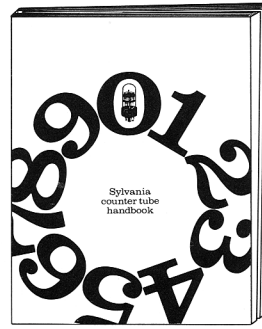

COUNTER TUBE HANDBOOK (ET-3911) — New brochure gives complete data on the applications of Sylvania Counter Tubes. Complete circuit design data supplemented by a variety of practical driver and system circuits.

SYLVANIA TECHNICAL MANUAL (ET-1901)—A handy desk reference that's a "must" for every dealer and distributor. 652 fact-filled pages with technical data on Receiving Tubes, CRT's, Microwave Devices, and many more. Price \$3.00, including supplemental mailings.

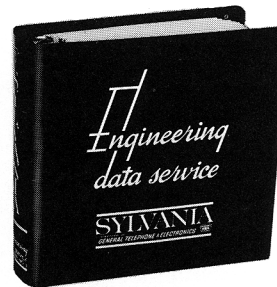
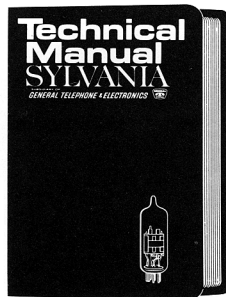

SYLVANIA ENGINEERING DATA SERVICE—The complete reference library. Comprehensive engineering data on over 2,000 types of Receiving Tubes, Cathode Ray Tubes, Microwave Devices, Counter Tubes, and Electroluminescent Display Devices in a series of binders. Approximately 7 supplemental inserts per year. By subscription.

ELECTRON TUBE APPLICATION NOTES (ET-3959)—The most comprehensive text available on the subject. Details the important parameters and considerations on electronic receiving tubes.

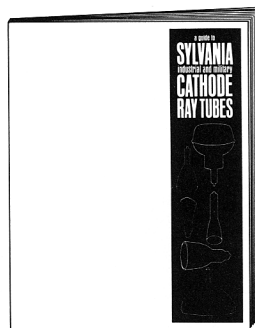
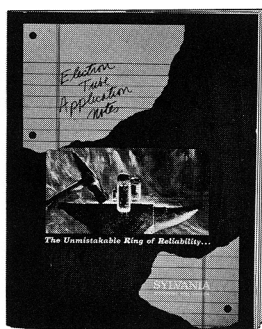

SYLVANIA I&M CATHODE RAY TUBES (ET-3914) — Nearly 250 I&M CRT types are catalogued in this new data brochure. Includes industrial monitors, receiver check tubes, oscilloscope tubes, radar indicators, and many more. Also a technical tabulation of standard registered phosphors.

ELECTRONIC COMPONENTS GROUP
Electronic Tube Division

